

märklin

1976 E



Märklin HO

Notes on the HO system
 The SET-HO program
 HO railroads
 HO locomotives
 Accessories for HO locomotives
 HO passenger cars
 HO freight cars
 HO building kits
 HO turntable and roundhouse
 HO grade crossings
 HO bridges
 HO train lighting
 HO locomotive accessories
 HO M-tracks
 HO K-tracks
 Signals for HO M-tracks
 Signals for HO K and M-tracks
 HO station lighting
 HO catenary systems
 for HO K and M-tracks
 Leads and control boxes
 Transformers
 HO publications
 Märklin magazine

1-63

1-4
 5-8
 9-11
 12-27
 47
 28-34
 35-41
 41
 42
 43-44
 45
 46
 47
 48-51
 52-53
 54-55
 56
 57
 58-59
 60
 61
 62
 63

Märklin mini-club

mini-club SET program
 mini-club railroads
 mini-club locomotives
 mini-club passenger cars
 mini-club freight cars
 mini-club building kits,
 grade crossing and bridges
 mini-club tracks
 mini-club catenary system and lighting
 mini-club accessories and power packs

64-81

65-68
 69
 70-71
 72-73
 74-75
 76-77
 78-79
 80
 81

Märklin I

Locomotives, cars, railroads,
 tracks and accessories

82-85**Märklin-Sprint****86-91****Märklin metall****92-95****Märklin plus****96-97**

Gebr. Märklin & Cie. GmbH
 Manufacturers of high
 quality toys
 D-7320 Göppingen



Trade mark

It is not possible to supply private customers directly from the factory. We reserve the right to make alterations, and availability of stock is not guaranteed. Accuracy of quoted dimensions not guaranteed. This catalog supersedes all previous issues.

All rights reserved ·
 Copying in whole or in part is prohibited ·
 Printed in Germany by Thiemig AG, Munich ·
 151 10—ML 06 76 th

Your Märklin dealer:

Progressive tradition and unique precision

Around the turn of the century, Märklin adopted the center conductor technique. This was the beginning of a development which has led logically to the Märklin HO railroad system of today. It is superior to all others in technical perfection and sets the standard for trouble free model railroading operations of all kinds.

Märklin attention to detail is made clear in the faithful reproduction of originals. The vast world of the railroad is reduced to a miniature sized hobby with no bounds to its scope. It's not for nothing that the Märklin HO system has achieved such success in Europe.

Historic locomotive with the first Märklin center-conductor track

Märklin tank locomotive with the modern center-conductor system

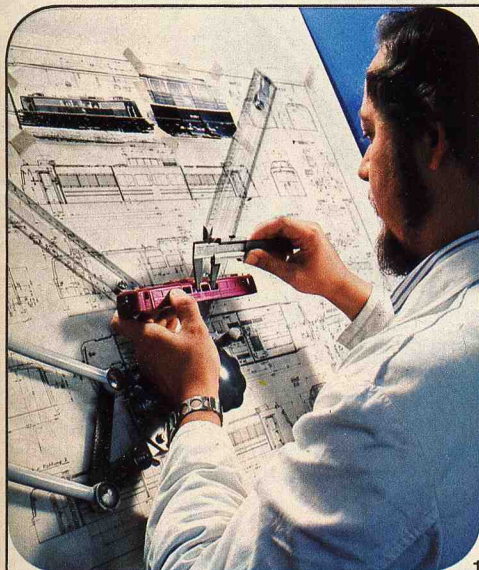
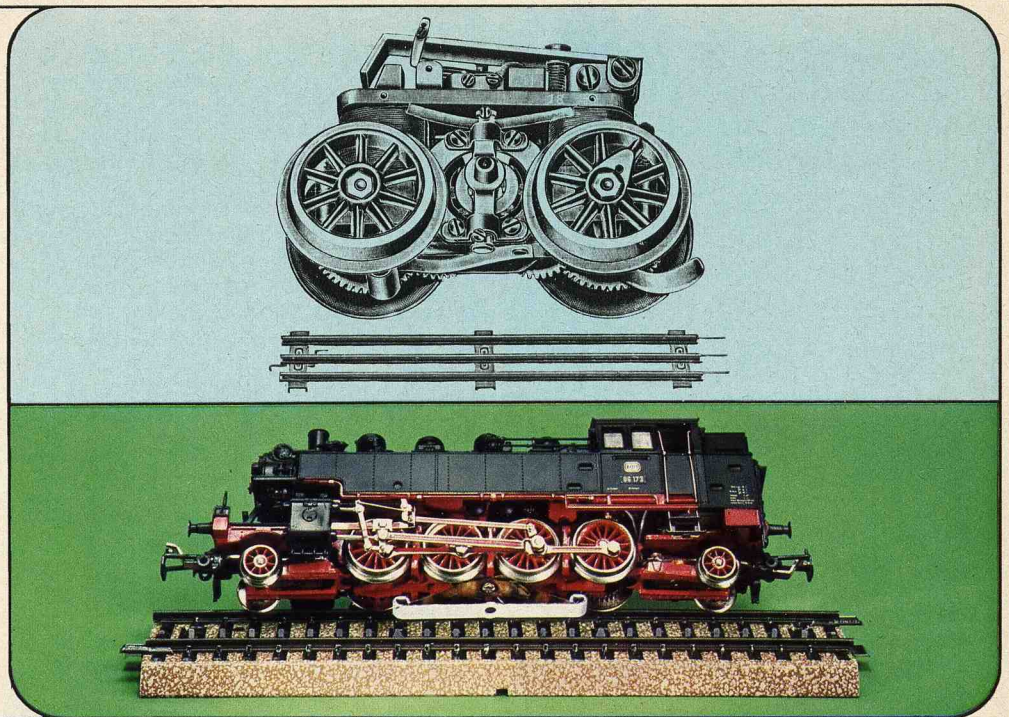

Märklin precision sets the standard for high quality technical toys. Years of experience and systematic quality control during manufacture have given Märklin its worldwide reputation.

No Märklin locomotive gets the "go ahead" signal until it has undergone extensive tests. Microscopes and magnifying glasses are just as much part of the production equipment as are the special machines and test equipments. But most important of all: the experienced fingers of the Märklin craftsmen.

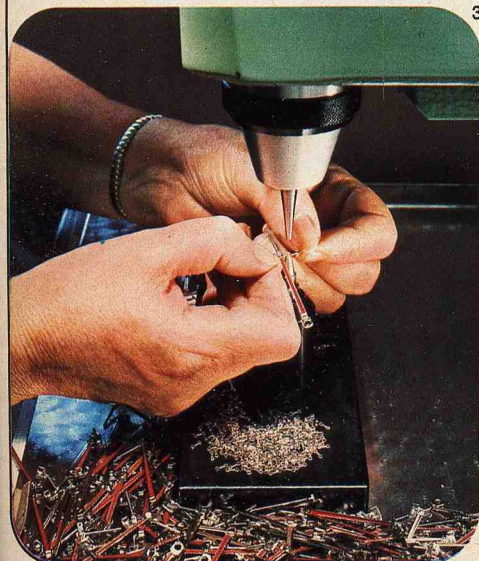

1 2
3 4

1. Planning and building accurately to scale
2. Transferring the contours of the model for construction in steel
3. Fitting driving rods to steam locomotives
4. Soldering an armature winding onto the commutator

All the information given here on the HO model railroad will be of interest to you.

(Even if you already have one.)

A Märklin HO model railroad layout, whether it is large or small, is always capable of being extended or refined. Yet each stage is a deeply satisfying task in itself. From the first little train in a landscape of building blocks and cartons, up to the extensive layout equipped with all the ingenious Märklin details, the small simple layout can be built up progressively into the large complex one. There is no end to the planning, modeling and constructing you can do with a model railroad, which will be a continual source of pleasure and relaxation whether you are 6 or 60.

The Märklin HO model railroad offers special advantages inherent in the design philosophy:

1. power supply via the central conductor of the Märklin HO track
2. use of alternating current supply only, for all components of a Märklin HO layout

These two features guarantee a reliable supply of current to the locomotives and a clear view of the current paths even on the most complex layout. Everything is easy to understand and is explained in any case in the instructions provided with the items.

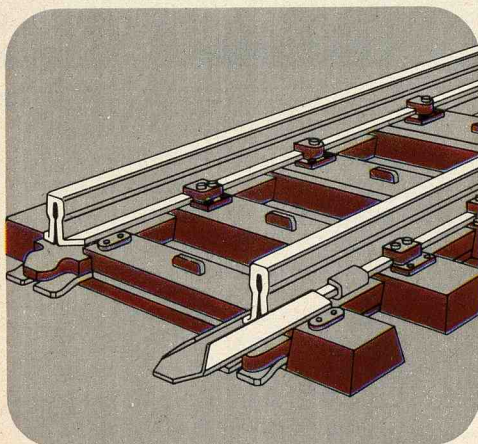

K-track (plastic cross-ties)

Six-fold connection between track sections, consisting of two rail clips, two sprung connectors for the central conductor and two couplings on the tie strip.

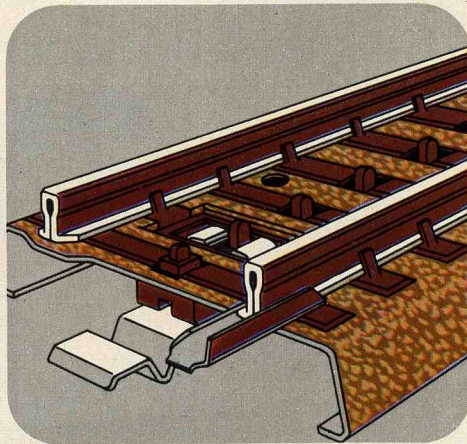

M-track (metal track body)

Triple connection between track sections consisting of a sprung connector for the central conductor and two rail clips.

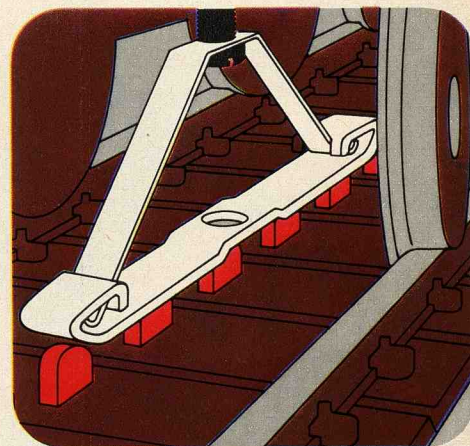

Reliable power supply

to the motor from point contacts via the pick-up shoe. Current return path via the locomotive wheels on both sides.

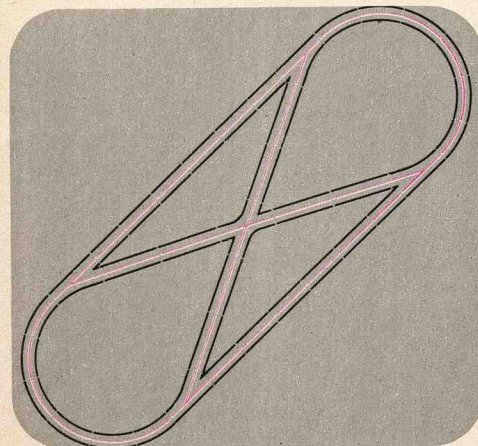

Simple circuitry making current paths easy to follow

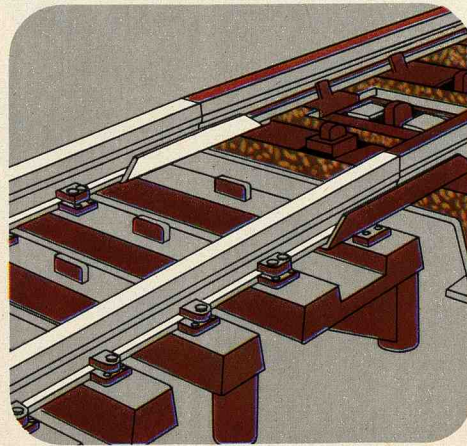

Adapter track section for the connecting M-track to K-track.



Reversing

of the locomotive by turning the control knob on the transformer anticlockwise (provides an over-voltage pulse).

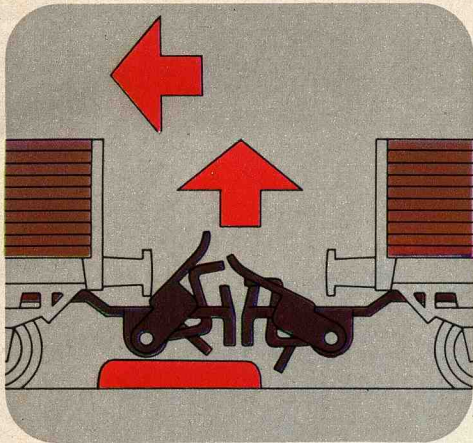

Automatic coupling

When cars are brought into contact, the coupling engages automatically. At the uncoupling track section, uncoupling can be carried out manually or by remote control.

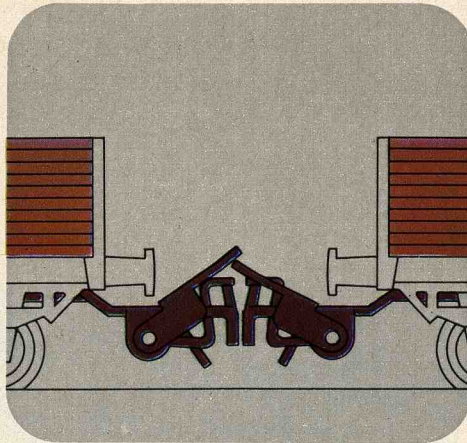

RELEX coupling

After uncoupling, the cars can be pushed for switching without the coupling re-engaging.

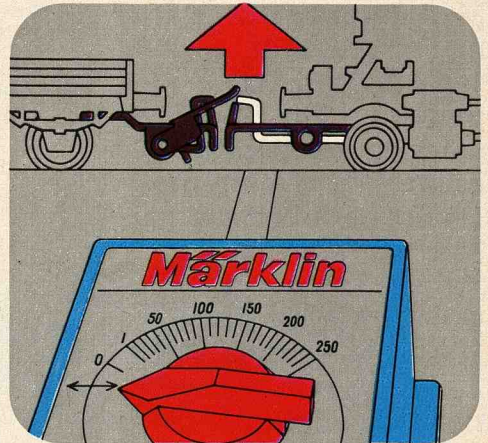

TELEX coupling

Uncoupling can be carried out at any point on the layout by remote control from the transformer.

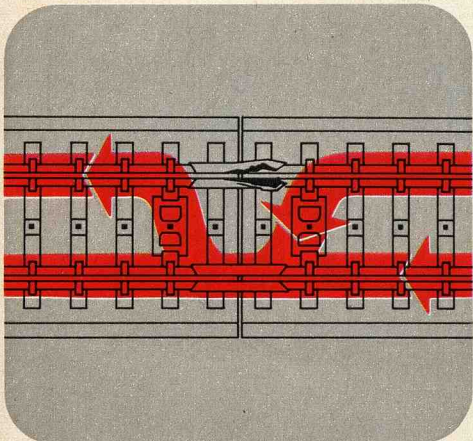

Reliable current return path,

because even if one of the two rail joint clips should get distorted the other one will still ensure a perfect mechanical and electrical connection.

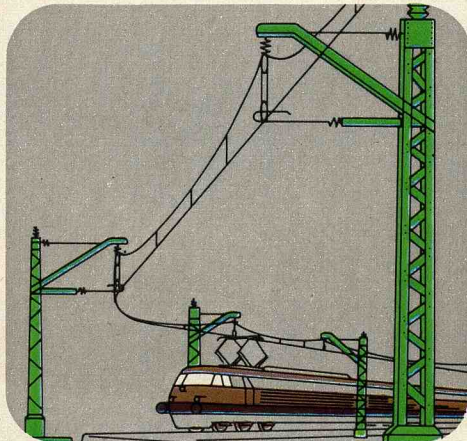

Catenary system

If the overhead conductor is wired up as a second circuit, two locomotives can be run independently of one another on the same track.

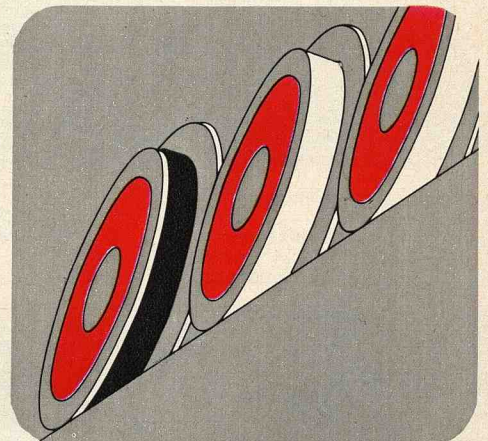

Non-skid tires

used on every locomotive to increase the pulling power by improving the grip of the wheels on the rails.

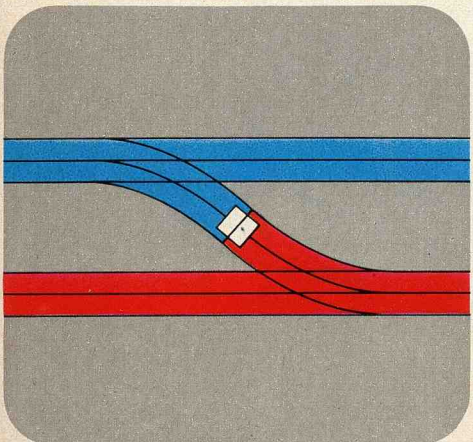

Circuit isolation

using center conductor isolator 5022 for M-tracks, or center conductor isolator 7522 for K-tracks. Special isolating track sections are not required.

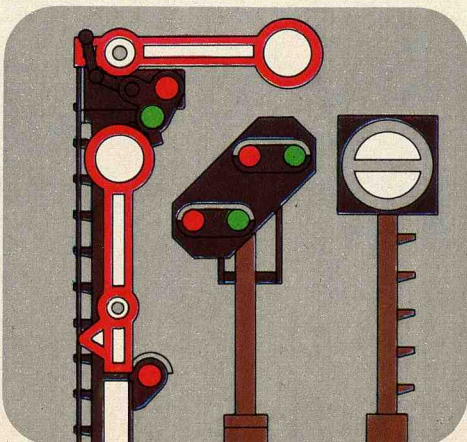

Signals

enable trains to be controlled fully automatically.

Radio interference suppression

All locomotives are fitted with suppressors. Compliance with German legal requirements for suppression is guaranteed, provided that feeder track sections 5131 or 2192, or the feeder masts 7201 or 7501 are used, and that exclusive use is made of Märklin items, which are matched for suppression purposes together with the Märklin transformers recommended.

Our suggestion
for an
ideal start:

SET-HO 123
with Toporama 7298

This layout consists of basic set **S** (2920—2929 or 2930—2939), extension set **E** 5190 or 5191, double track set **T** 1 5192, station track set **T** 2 5193 and switching track set **T** 3 5194 = SET 123 and Toporama 7298. See page 8 for track plan and parts list. See also pages 6—9.

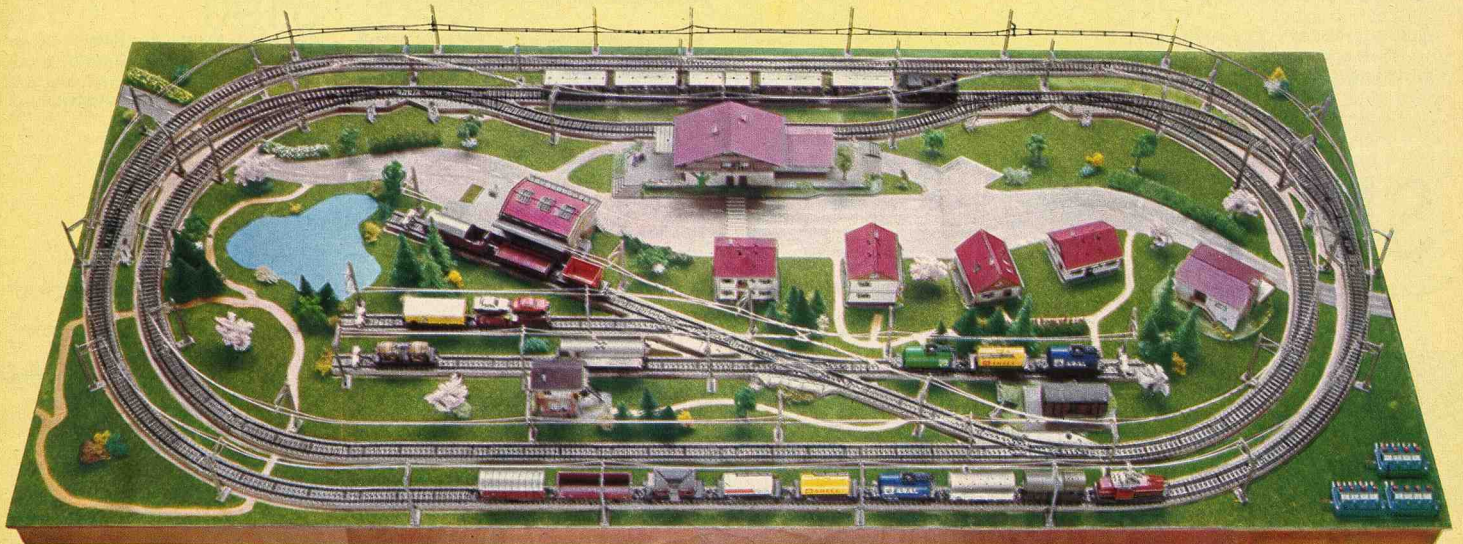

Part of the SET-HO 123 layout ▼



You start with a **gift set S** containing a **passenger train S 2920-2929** or a **freight train S 2930-2939** each with transformer and oval track (see page 9).

The first extension stage is an **extension set E 5190** or **extension set E 5191**.

From here on, three further track extension sets are available for building up to the ideal HO layout:

- double track set T 1 5192**
- station track set T 2 5193**
- switching track set T 3 5194**

The three track sets T 1, T 2 and T 3 can be added in any order. Here we show only four of the ways leading from a small beginning to the ideal HO layout. You can consider any of these ways, depending on how you prefer to operate your layout, or you can devise some variation of your own. With Märklin SET-HO extension program, the build-up to the ideal HO layout is as easy as that.



Passenger train S 2920-2929

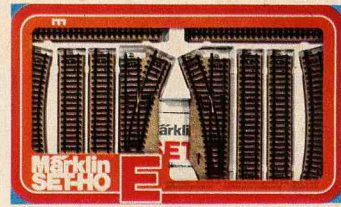

5190

Extension set E · Contents: 10 straight track sections 5106, 2 curved track sections 5206, one pair of manually operated turnouts 5221 and instructions for extending the layout



Freight train S 2930-2939

SET-HO

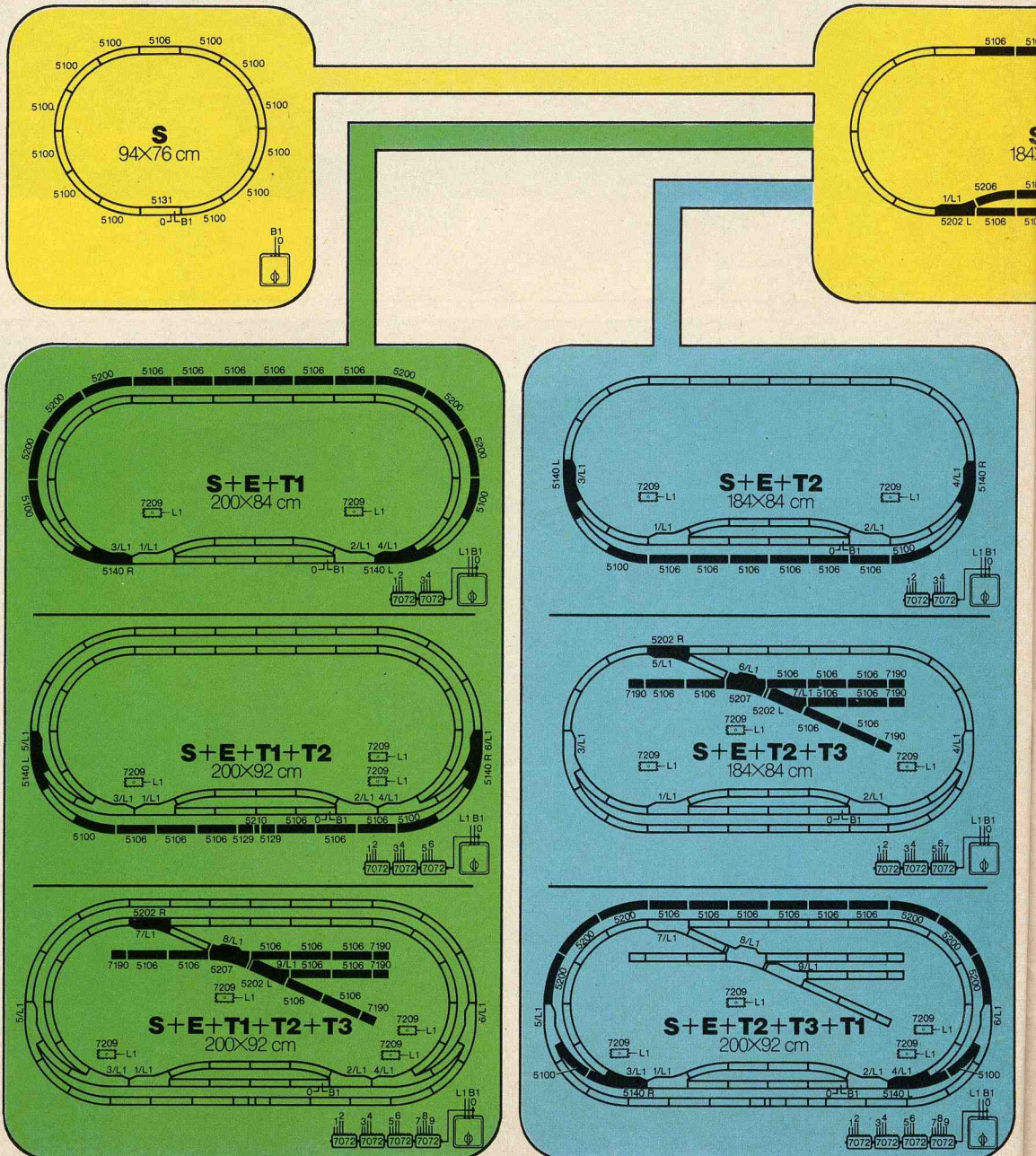

The Märklin SET-HO extension program culminates in the addition of the HO catenary system. You will find a very interesting suggestion about this on page 8.

The Märklin range also includes many kinds of accessories which can increase the scope of your rail-roading operations, e.g. signals, bridges, rotating crane, lights, etc.



5191

Extension set E · Contents: 10 straight track sections 5106, 1 pair of solenoid-operated turnouts 5202, 2 curved track sections 5206, 1 control box 7072, 1 distribution strip 7209, connector materials such as leads, sleeves and plugs · Instructions for extending the layout



5192

Double track set T1 · Contents: 2 curved track sections 5100, 6 straight track sections 5106, 1 pair of solenoid-operated curved turnouts 5140, 6 curved track sections 5200, 1 control box 7072, 1 distribution strip 7209, connector materials such as leads, sleeves and plugs · Instructions for extending the layout

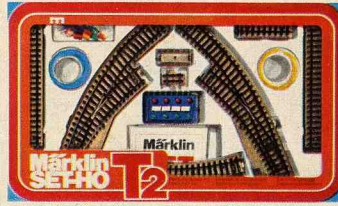

5193

Station track set T2 · Contents: 2 curved track sections 5100, 6 straight track sections 5106, 2 straight track sections 5129, 1 pair of solenoid-operated curved turnouts 5140, 1 straight track section 5210, 1 control box 7072, 1 distribution strip 7209, connector materials such as leads, sleeves and plugs · Instructions for extending the layout



5194

Switching track set T3 · Contents: 9 straight track sections 5106, 1 pair of solenoid-operated turnouts 5202, 1 double slip switch 5207, 1 control box 7072, 4 bumpers 7190, 1 distribution strip 7209, connector materials such as leads, sleeves and plugs · Instructions for extending the layout

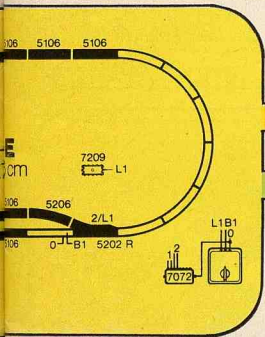

7298

Märklin-Toporama for the Märklin SET-HO extension program leading to the ideal HO layout · Printed, realistic railroad landscape · Multi-colored presentation · Track layout up to SET 123 is printed · Tufted grass areas give a three dimensional effect · Size 205 × 97 cm

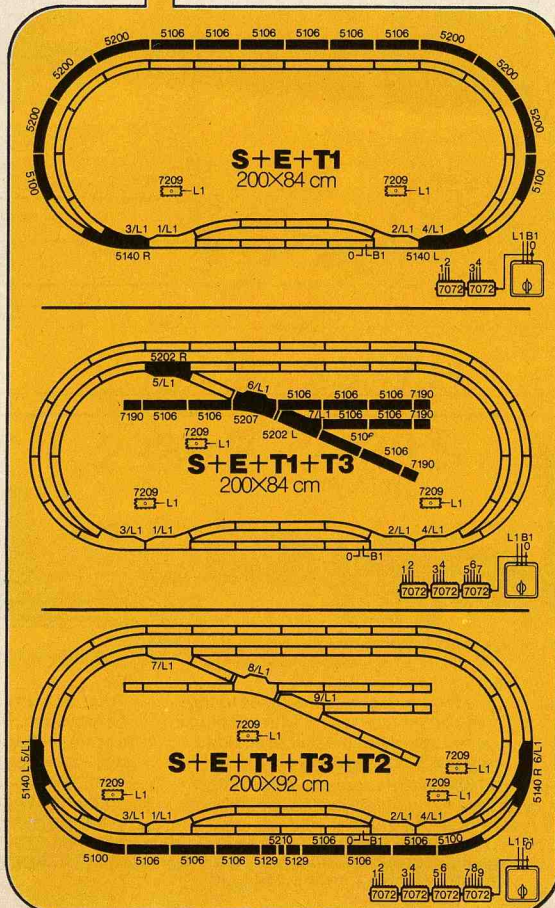
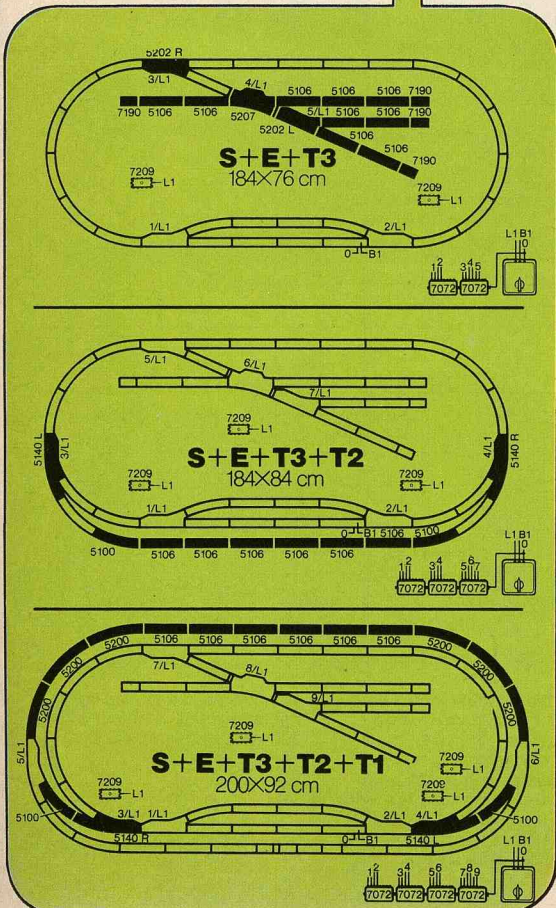

The Märklin-Toporama 7298 is highly recommended as a way of enhancing Märklin SET-HO. The Toporama can be used from stage E (5190, 5191) onwards. The track layout up to stage T3 (5194) is printed.

And how is the Toporama used?

It is quite simple: glue or fasten the Toporama mat on a firm base, lay the real track over the full-scale printed one, make the connections and you are ready to go. No other landscaping is necessary; the Märklin Toporama includes meadows, streams, lakes, roads and parking lots.

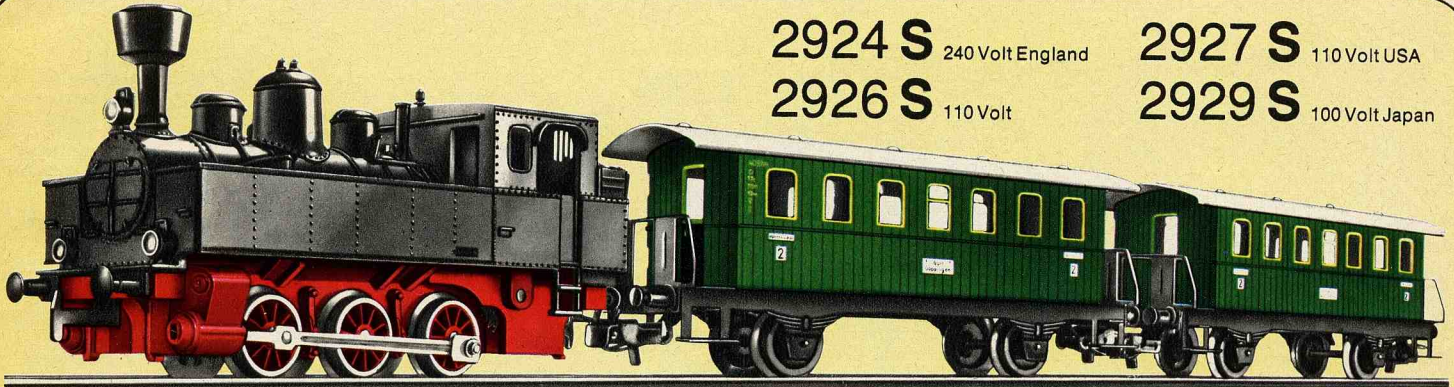

2924 S 240 Volt England
2926 S 110 Volt

2927 S 110 Volt USA
2929 S 100 Volt Japan

All train sets on this page have an oval track and a transformer with traction and lighting current connections.

2920 S 220 Volt
Local passenger train with transformer
With tank locomotive, 2 passenger cars, 12 curved track sections 5100, 1 straight track section 5106, 1 feeder track section 5131 with built-in capacitor for radio interference suppression and 1 transformer. Length of train 35 cm

Like all Märklin railroad transformers, the ones included in these sets have connections for traction current and current for lights and solenoid-operated items, as well as providing an overvoltage for reversing the locomotives. The transformers can also be used to drive bigger locomotives or additional turnouts or signals. The transformer switches itself off if subjected to overloading or excessive temperature.



The transformers supplied with these basic sets are not available separately.



2934 S 240 Volt England
2936 S 110 Volt

2937 S 110 Volt USA
2939 S 100 Volt Japan

Fully extendable basic sets.

2930 S 220 Volt
Freight train with transformer · With locomotive 3000, 2 freight cars, 12 curved track sections 5100, 1 straight track section 5106, 1 feeder track section 5131 with built-in capacitor for radio interference suppression and 1 transformer. Length of train 31.5 cm

For the basic sets 2920-2929 and 2930-2939 we recommend the Märklin SET-HO, an extension program building up to the Ideal HO layout, using items E (5190, 5191), T 1 (5192), T 2 (5193) and T 3 (5194). For detailed descriptions see pages 5-8.



Connect transformers to AC mains supply only.

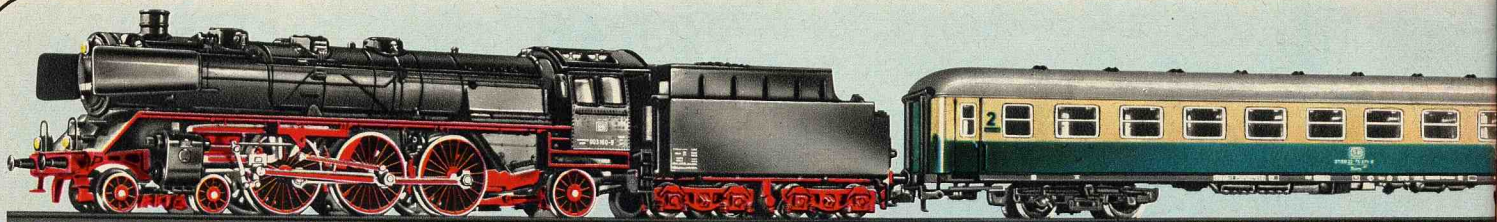

3185 S + E

Express train with turnouts (without transformer) · With express locomotive 3085, 1 each long-distance pas-

senger cars 4092, 4093 and 4094, 12 curved track sections 5100, 11 straight track sections 5106, 1 feeder track section 5131 with built-in capacitor for radio interference sup-

pression, 1 pair solenoid-operated turnouts 5202, 2 curved track sections 5206, 1 control box 7072, 1 distribution panel 7209 and 2 leads · Length of train 113 cm



3175

Express train (without transformer) · With diesel locomotive 3075, 2 long-distance passenger cars with interior fittings, 1 long-distance baggage car, 12 curved track sections 5100, 5 straight

track sections 5106 and 1 feeder track section 5131 with built-in capacitor for radio interference suppression · Length of train 93.5 cm

For enlarging the train set 3175 we recommend the publications "HO gauge track layouts for M-tracks" 0321 and 0392 (see page 62).



3203 S

Freight train (without transformer) · With locomotive 3003, 3 freight cars, 12 curved track sections 5100, 1 straight track section 5106 and 1 feeder track section 5131 with built-in capacitor for radio interference suppression · Length of train 53 cm

For enlarging the train set 3203, we recommend Märklin SET-HO, an extension program leading to the ideal HO layout, using items E (5190, 5191), T 1 (5192), T 2 (5193) and T 3 (5194). For detailed descriptions see pages 5-8.



Train sets without transformer,
with oval track –
full extension capability

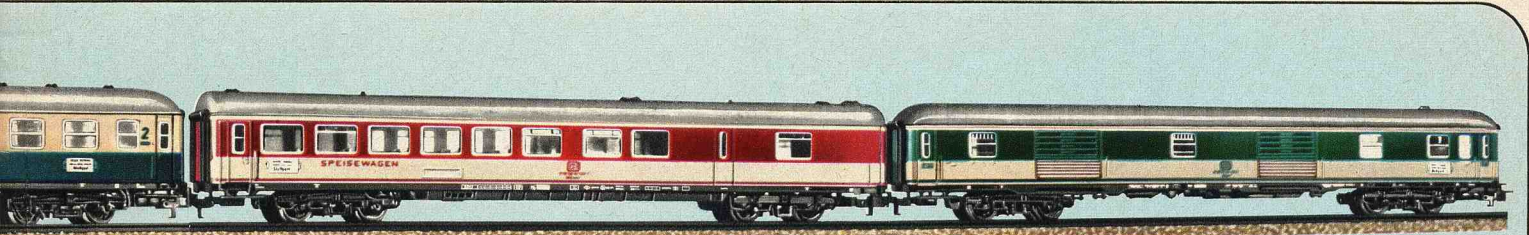

For enlarging the train set 3185 we recommend using the following items from the Märklin SET-HO extension program: T 1 (5192), T 2 (5193) and T 3 (5194). For detailed descriptions see pages 5–8.

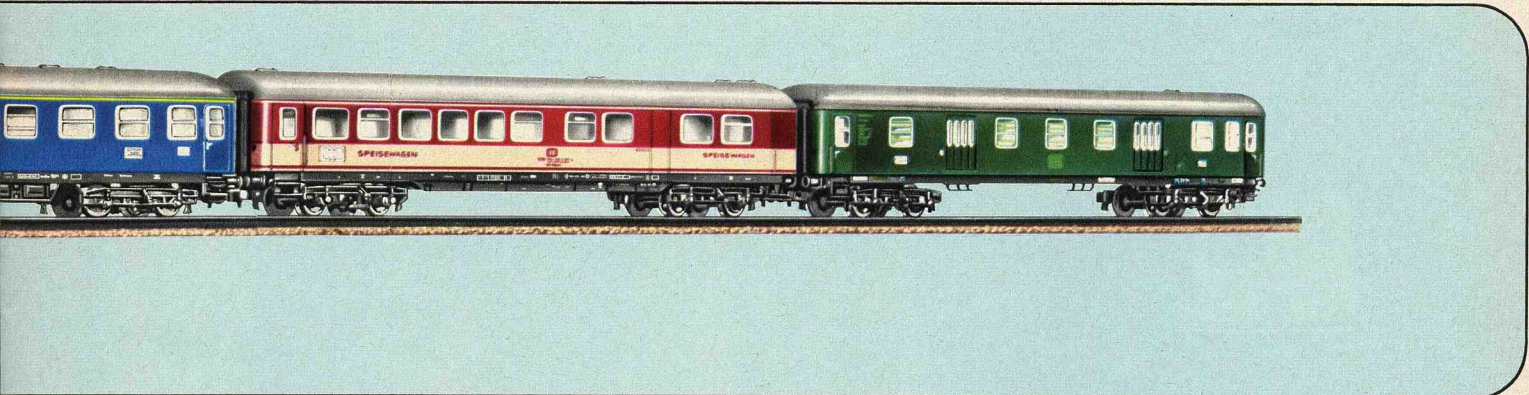

Gift packs – a good idea

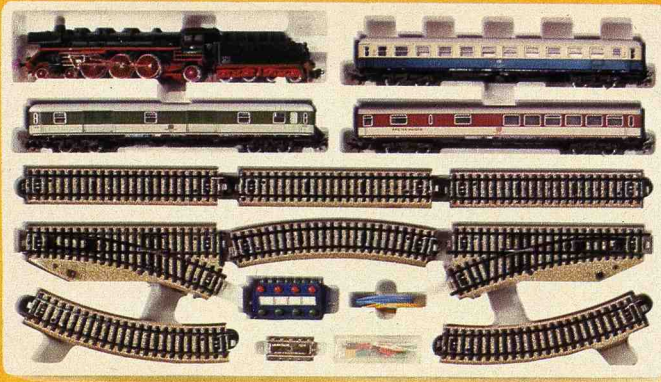

These bigger train sets, with more cars and more track sections, are really something else. An ideal gift for someone – or for yourself. A good way to start out on a larger scale, for example. The only other item you have to buy is one of the transformers on page 61 – and the set is ready to run immediately.







Tank locomotive

3087

Tank locomotive modeled on a 0-6-0 type used on secondary lines · 1 driven axle · 2 non-skid tires · Remote control for forward and reverse drive · Green and black plastic body · Green water

tanks and engineer's cab · Die cast zinc frame · Coupling hooks at each end · Length over buffers 10.8 cm

⊙ = 7154 ⊞ = 7185

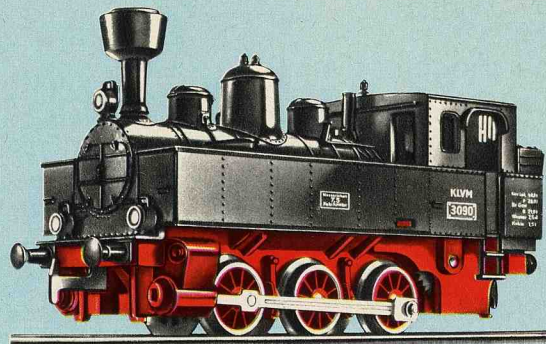

Tank locomotive

3090

Tank locomotive modeled on a 0-6-0 type used on secondary lines · 1 driven axle · 2 non-skid tyres · Remote control for forward and reverse drive · Mat black plastic body · Die cast zinc

frame · Coupling hooks at each end · Length over buffers 10.8 cm

⊙ = 7154 ⊞ = 7185

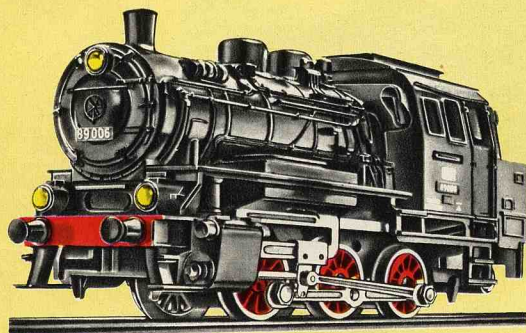

Tank locomotive

3000

Tank locomotive · Model of the 0-6-0 class 89 locomotive · 3 driven axles · 2 non-skid tires · Remote control for forward and reverse drive · Three working headlights · Mat black plastic body · Die cast zinc frame · Coupling hooks at each end · Length over buffers 11 cm

Many people favor these double end locomotives because of the many uses to which they can be put in passenger and freight train service, especially for work in switching yards, and for their design and the ease with which they can be put on the track. Their ability to stay on curves at high speed and to pull heavy loads and their attractive appearance are special advantages of these locomotives.

⊙ = 7154 ⊞ = 7185 ⊚ = 60010

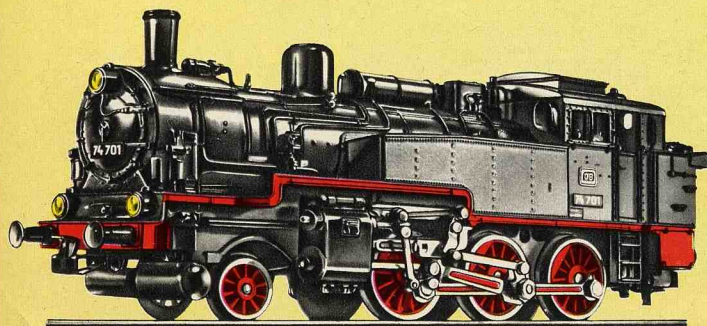

"BR 74" A very desirable Märklin model

3095

Tank locomotive · A model of the German Federal Railways 2-6-0 class 74 locomotive · 3 driven axles · 2 non-skid tires · Simulated Heusinger reversing gear · Remote control for forward and reverse drive · Three working headlights · Mat black plastic body · Die cast zinc frame · Coupling hook with advance uncoupler at the front, automatic coupling with advance uncoupler (RELEX) at rear · Length over buffers 13.5 cm

The first of these superheated steam tank locomotives was put into service by the Royal Berlin Railways in 1902. It proved so successful that hundreds of the same type were working untiringly for suburban passenger services until the 1920's, when the Berlin city and circle line was electrified. Over the years nearly 1000 of these very reliable machines were built. When they were no longer required in Berlin, other railroad centers took them over for use on local passenger services and for switching operations. Their length was 11.80-12 m. With a working weight of 70 tons they could reach a speed of 80 km/h either forwards or backwards.

⊙ = 7153 ⊞ = 7185 ⊚ = 60010

“BR 86”
standard locomotive
used on the German
Federal Railways
with Märklin
TELEX coupling

3096

Tank locomotives · A model of the German Federal Railways, 2-8-2 class 86 locomotive · 4 driven axles · 2 non-skid tires · Simulated Heusinger reversing gear · Remote control for forward and reverse drive · 3 working headlights at each end · Outstandingly detailed black plastic body with many fittings · Die cast zinc frame · **Märklin TELEX coupling** at each end · Length over buffers 15.8 cm

0 = 7153  = 7164  = 60015

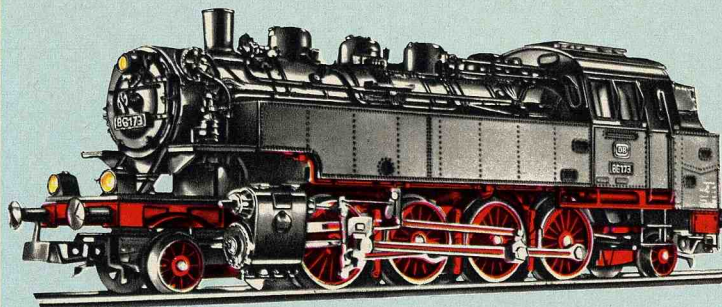

The standard class 86 locomotive, which was developed for mixed service on secondary lines with a high traffic-density, achieved the respectable representation of 774 machines in the stocks of the former German State Railways. The German Federal Railways acquired 385 of these, which have since been taken out of service. Some machines were equipped with Krauss-

Helmholtz frames, enabling the speed to be raised from the original 70 to 80 km/h. Length of locomotive is 13.82 m. At the working weight of 88.5 tons the maximum axle load is 15.6 tons.

The Märklin **TELEX coupling** enables the attached train to be uncoupled at any point on the track, by remote control from the transformer. Trains can also be coupled-up at any desired point, again using the automatic coupling. No extra equipment is required.

The following locomotives are equipped with Märklin TELEX couplings: 3096 and 3065 (see page 23).

Mixed traffic locomotive

3003

Passenger locomotive with tender · A model of the German Federal Railways 2-6-0 class 24 locomotive · 3 driven axles · 2 non-skid tires · Simulated Heusinger reversing gear · Remote control for forward and reverse drive · 3 working headlights · Mat black plastic body · Die cast zinc frame · Coupling hook in front · Automatic coupling with advance uncoupler (RELEX) · Length over buffers 20 cm

0 = 7153  = 7185  = 60010

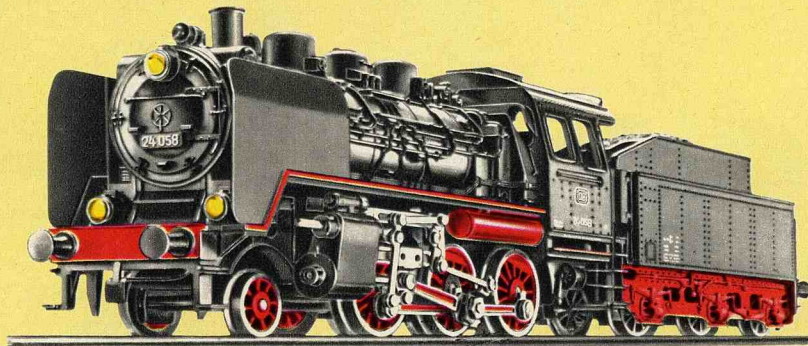



The standard class 24 locomotive was used on German Federal Railways for local passenger and freight services. Its maximum speed was 90 km/h.

The beautiful “P 8”
as a Märklin model

3098

Locomotive with tender · A model of the German Federal Railways 4-6-0 class 38 locomotive · 3 driven axles · 2 non-skid tires · Simulated Heusinger reversing gear · Remote control for forward and reverse gear · 3 working headlights · Mat black metal body with detailed representation of the fittings on the boiler and in the engineer's cab · Die cast zinc frame · Trough shaped tender on two trucks · Coupling hook in front · Automatic coupling with advance uncoupler (RELEX) on the tender · Length over buffers 23.7 cm

0 = 7152  = 7185  = 60015

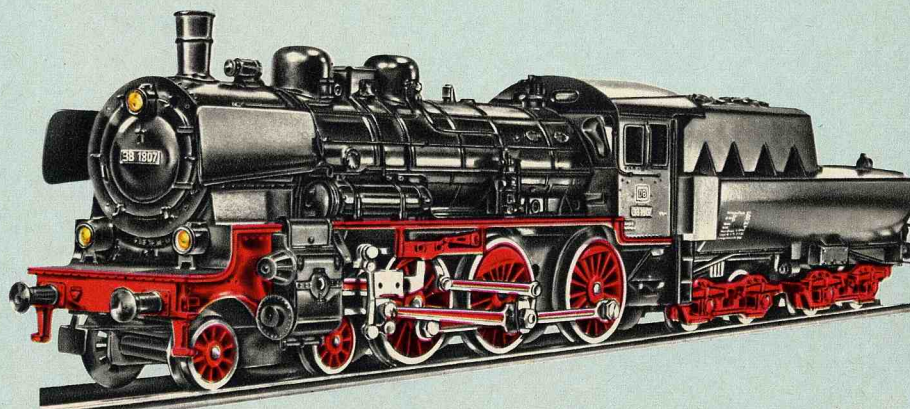

The P 8 was built by Schwartzkopff in Berlin as early as 1906 and was put into service on the Prussian State Railways for express and local passenger services. Although its maximum permitted speed was only

100 km/h, it remained a favored type of locomotive in several regions for many years because of its reliability. 3800 of these machines were eventually produced by a number of different firms.

Heavy freight locomotive with cab tender

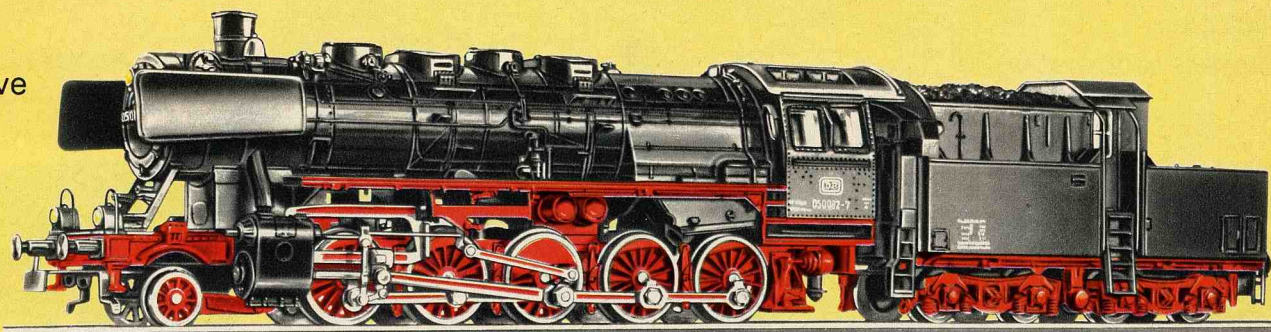

3084

Heavy freight locomotive with cab tender · A model of the German Federal Railways 2-10-0 class 050 locomotive · 5 axles driven by concealed gears · 4 non-skid tires · To give easy running on curves, the frame is

divided into two groups of driving wheels, flexibly coupled together · Simulated Heusinger reversing gear · Remote control for forward and reverse drive · 3 working headlights · Mat black plastic and metal body in finest detail · Die cast zinc frame · Coupling hook in front, automatic coupling with advance uncoupler (RELEX) on

tender · Length over buffers 26.1 cm · **This locomotive can be fitted with the smoke set 7226 (see page 47)**

⊙ = 7153 ⊞ = 7164 ⊚ = 60015

Because of its low axle load of 15 tons, this freight locomotive, now known as class 050, can also be used on light rail-

roads. Most European locomotive manufacturers shared in the building of over 3000 of these machines. In the sixties, most of the locomotives still in service had an engineer's cab incorporated in the tender, making them even more versatile. Maximum speed is 80 km/h, at which the machine develops 1625 HP. Length over buffers 22.94 m.

German Federal Railways' express locomotive "BR 003"

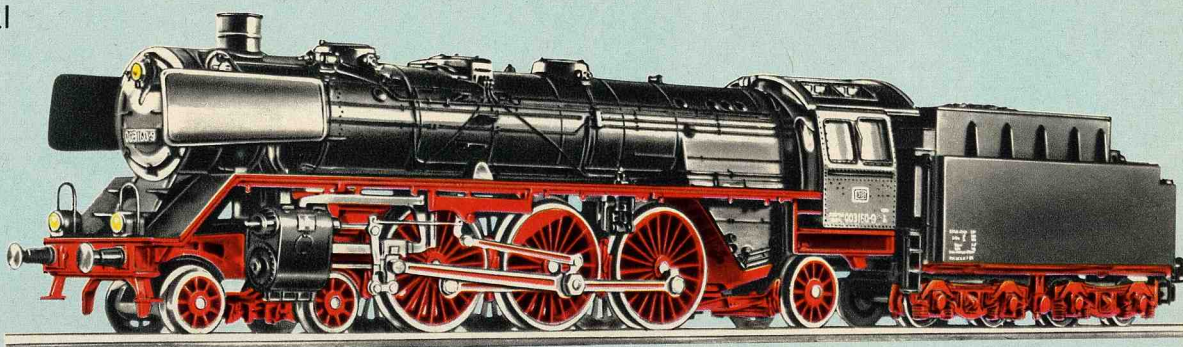

3085

Express locomotive with tender · A model of the German Federal Railways 4-6-2 class 003 locomotive · 3 axles driven by concealed gears · 2 non-skid

tires · Simulated Heusinger reversing gear · Remote control for forward and reverse drive · 3 working headlights · Mat black plastic and metal body in very fine detail · Die cast zinc frame · Automatic coupling with advance uncoupler (RELEX) on tender · Length over buffers 27.7 cm ·

This locomotive can be fitted with the smoke set 7226 (see page 47)

⊙ = 7152 ⊞ = 7164 ⊚ = 60015

The former German State Railways used about 300 class 03 (now known as

class 003) locomotives, a lighter version of the class 01, for pulling express trains on track sections where an axle load as high as 20 tons was not permitted. They developed 1980 HP giving a maximum speed of 130 km/h. Coupled to the T32 tender the overall length over the buffers was 23.90 m.

Express locomotive with tender "S3/6"

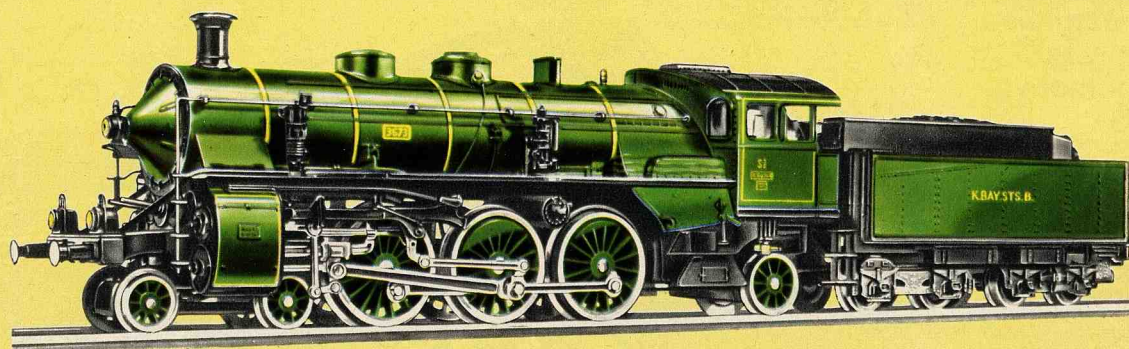

3092

Express locomotive with tender · A model of the former Royal Bavarian Railways 4-6-2 class S3/6 series I locomotive · 3 driven axles · 2 non-skid tires · Simulated Heusinger reversing gear · Remote control for forward and reverse drive · 3 working head-

lights · Dark green metal body with yellow boiler hoops · Fairing at the engineer's cab · Fittings accurately detailed · Die cast zinc frame · Automatic coupling with advance uncoupler (RELEX) on the tender · Length over buffers 24.9 cm ·

This locomotive can be fitted with the smoke set 7227 (see page 47)

⊙ = 7152 ⊞ = 7185 ⊚ = 60015

“BR 18”
express locomotive

3093

Express locomotive with tender · A model of the German Federal Railways 4-6-2 class 18^a locomotive (Bavarian class S3/6, Series i) · 3 driven axles · 2 non-skid tires · Simulated Heusinger reversing gear · Remote control for forward and reverse drive · 3 working headlights · Mat black metal body · Fittings very finely detailed · Die cast zinc frame · Automatic coupling with advance uncoupler (RELEX) on the tender · Length over buffers 24.9 cm · **This locomotive can be fitted with the smoke set 7227 (see page 47)**

⊙ = 7152 ⊞ = 7185 ⊚ = 60015

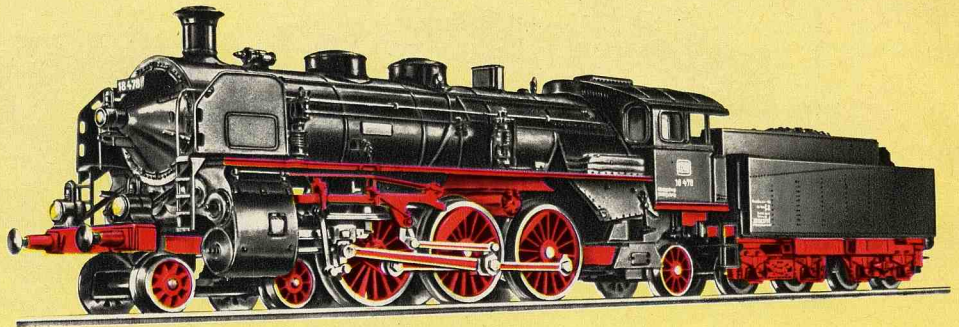

Connoisseurs regard the Bavarian class S3/6 locomotive, with its powerful cylinder group, clearly arranged underframe, streamlining and characteristic rimmed smoke stack, as the finest steam locomotive of all. The S3/6s, later re-designated class 18^a by the German State Railways, were often used to pull international ex-

presses, including the famous “Rheingold”, not only because of their appearance but also because of their excellent performance. They reached a maximum speed of 120 km/h at a working weight of 92.3 tons. Their length over the buffers was 21.22 m. The last machine of this type, No. 18478, was taken out of service in July, 1960.

Belgian
State Railways’
locomotive
with tender

3086

Locomotive with tender · A model of the Belgian State Railways (NMBS/SNCB) 4-6-0 class 64 locomotive · 3 driven axles · 2 non-skid tires · Simulated Heusinger reversing gear · Remote control for forward and reverse drive · 3 working headlights · Green metal body, bronze-colored boiler hoops and external piping · Die cast zinc frame · Coupling hook in front, automatic coupling with advance uncoupler (RELEX) on the tender · Length over buffers 21.4 cm

⊙ = 7152 ⊞ = 7185 ⊚ = 60015

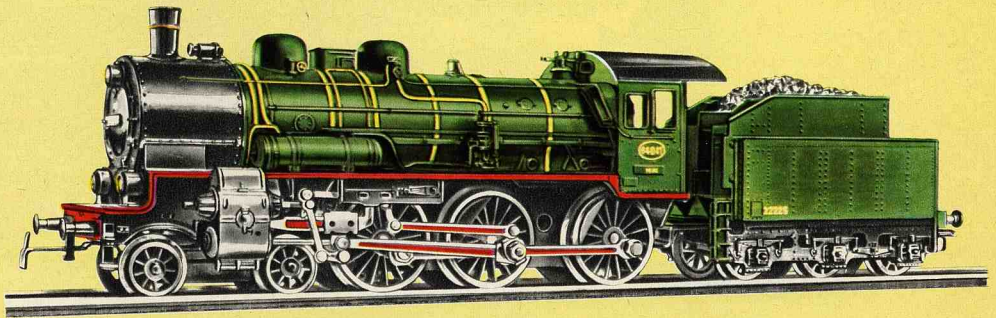

Streamlined
express
locomotive
“03¹⁰”

3089

Streamlined express locomotive with tender · A model of the 4-6-2 class 03¹⁰ locomotive · 3 driven axles · 2 non-skid tires · Simulated Heusinger reversing gear · Remote control for forward and reverse drive · 2 working headlights · Dark red streamlined body with silver stripes · Black smoke deflector plates · Detailed simulation of fittings on boiler and in engineer’s cab · Die cast zinc frame · Automatic coupling with advance uncoupler (RELEX) on the tender · Length over buffers 27.4 cm

⊙ = 7152 ⊞ = 7185 ⊚ = 60015

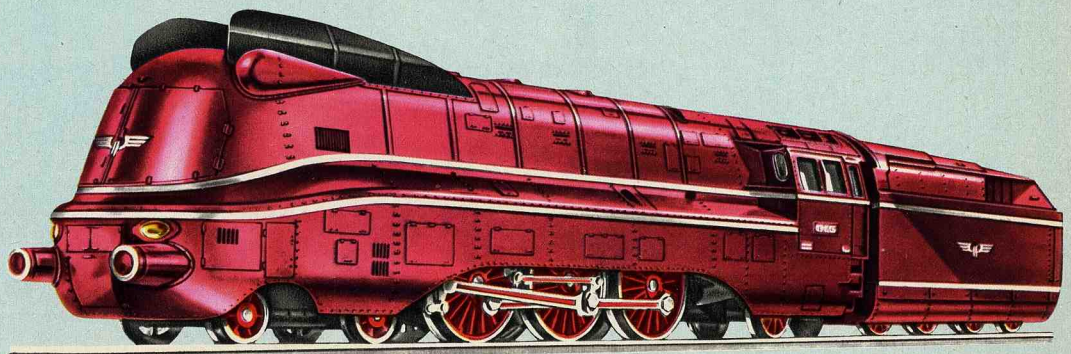



In 1937, after the value of streamlined fairings in reducing drag at high speeds had been proved on other locomotives, the three-cylinder class 03¹⁰ with streamlined fairings was put into service. For easier maintenance, however, the driving

gear was left uncovered. The locomotive was developed as a lighter version of the class 01, and originally had an axle load of 17 tons and a maximum speed of 140 km/h.

“141” the multipurpose electric locomotive



3034

Electric locomotive · A model of the German Federal Railways B-B class 141 locomotive · 2 driven axles · 4 non-skid tires · Remote control for forward and reverse drive · 3 working headlights at each end · Lever for selecting operation by overhead line or track supply · 2 spring loaded pantographs on roof · Turquoise and beige metal body · Coupling hook with advance uncoupler at each end · Length over buffers 17.5 cm

0 = 7153  = 7164  = 60015

3037

Electric locomotive · A model of the German Federal Railways class 141 locomotive · Similar to 3034, except that the body is green

0 = 7153  = 7164  = 60015

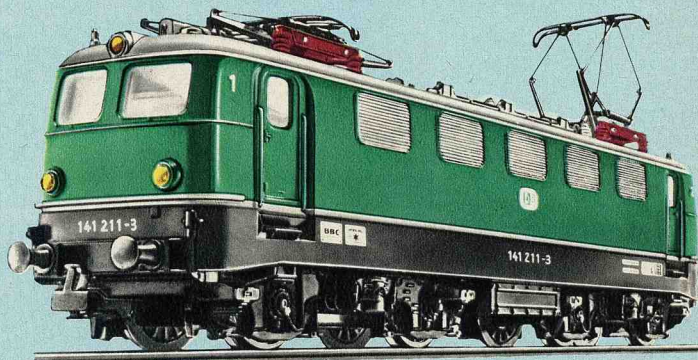

The class 141 locomotive has a working weight of 66.4 tons and a length of 15.66 m. Its four motors are rated at a total of 3100 HP continuous. The maximum speed is 120 km/h. The locomotive is used for passenger and freight services.



Electric express locomotive “110”

3039

Electric express locomotive · A model of the German Federal Railways B-B class 110 locomotive · 2 driven axles · 4 non-skid tires · Remote control for forward and reverse drive · 3 working headlights at each end · Lever for selecting operation by overhead line or track supply · Blue metal body · Outstanding reproduction of all roof details · 2 spring loaded pantographs on roof · Silver-colored roof · Windows inset in plastic frames · Coupling hook with advance uncoupler at each end · Length over buffers 18.1 cm

0 = 7153  = 7164  = 60015

The class 110 electric locomotives were purchased by the German Federal Railways from 1956 onward. The 110 is used as an express locomotive, with a maximum permitted speed of 150 km/h. The

class 110 locomotive has 4 motors giving a total of about 5000 HP. The locomotive weighs 85 tons and its length over the buffers is 16.44 m.

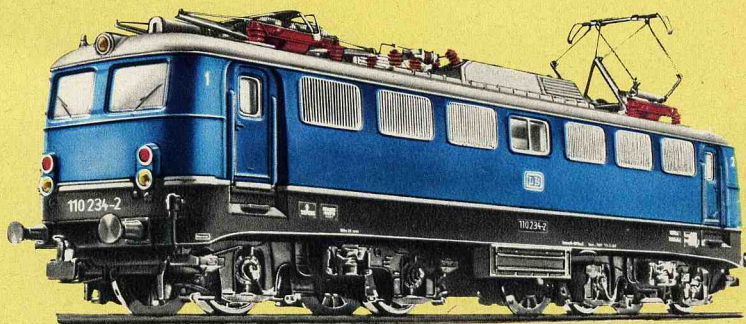

Electric switching locomotive “EA 800”

3044

Electric locomotive · A model of the 0-6-0 Type EA 800 multisystem industrial locomotive · 3 driven axles · 2 non-skid tires · Remote control for forward and reverse drive · Lever for selecting operation by overhead line or track supply · 3 working headlights at each end · Red plastic body · Single bar current collector on roof · Die cast zinc frame · Finely detailed axle box covers · Coupling hook at each end · Length over buffers 11.2 cm

0 = 7154  = 7185  = 60015

The locomotives of this type were built for heavy track and switching service on works' rail systems, and for transferring cars to mainline railroads. They can draw current either from overhead lines or from internal batteries. Their maximum speed is 50 km/h. The locomotive develops a starting tractive force of 19 500 kg with single-axle drive. Its weight is 60 tons and its length 10.20 m.

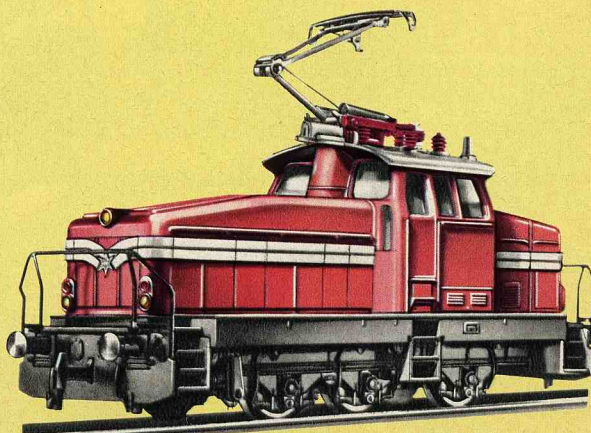

Freight locomotive "151"

3058 **new**

Electric freight locomotive · A model of the German Federal Railways' C-C class 151 locomotive · 3 driven axles · 4 non-skid tires · Remote control for forward and reverse drive · 3 working headlights at each end · Lever for selecting operation by overhead line or track supply · Interior fittings simulated · Die cast zinc frame, giving a favorable center of gravity position · Turquoise and beige plastic body · Windows inset in plastic frames · 2 spring loaded pantographs on roof · Coupling hook at each end · Length over buffers 22.2 cm

○ = 7153 ⚙ = 7164 ⚡ = 60015

With the speed of fast freight trains increasing to 120 km/h, the development of a new heavy freight locomotive became necessary. By using components which had proved themselves in other locomotives, a new very powerful traction unit was produced in a short time and ready to roll.

With a working weight of only 118 tons, the locomotive develops a starting tractive force of 45 tons, and with its six motors developing a total of 6540 kW continuous rating it can pull a 1000 ton train on the level at 120 km/h. The class 151 locomotives are 19.49 m long.

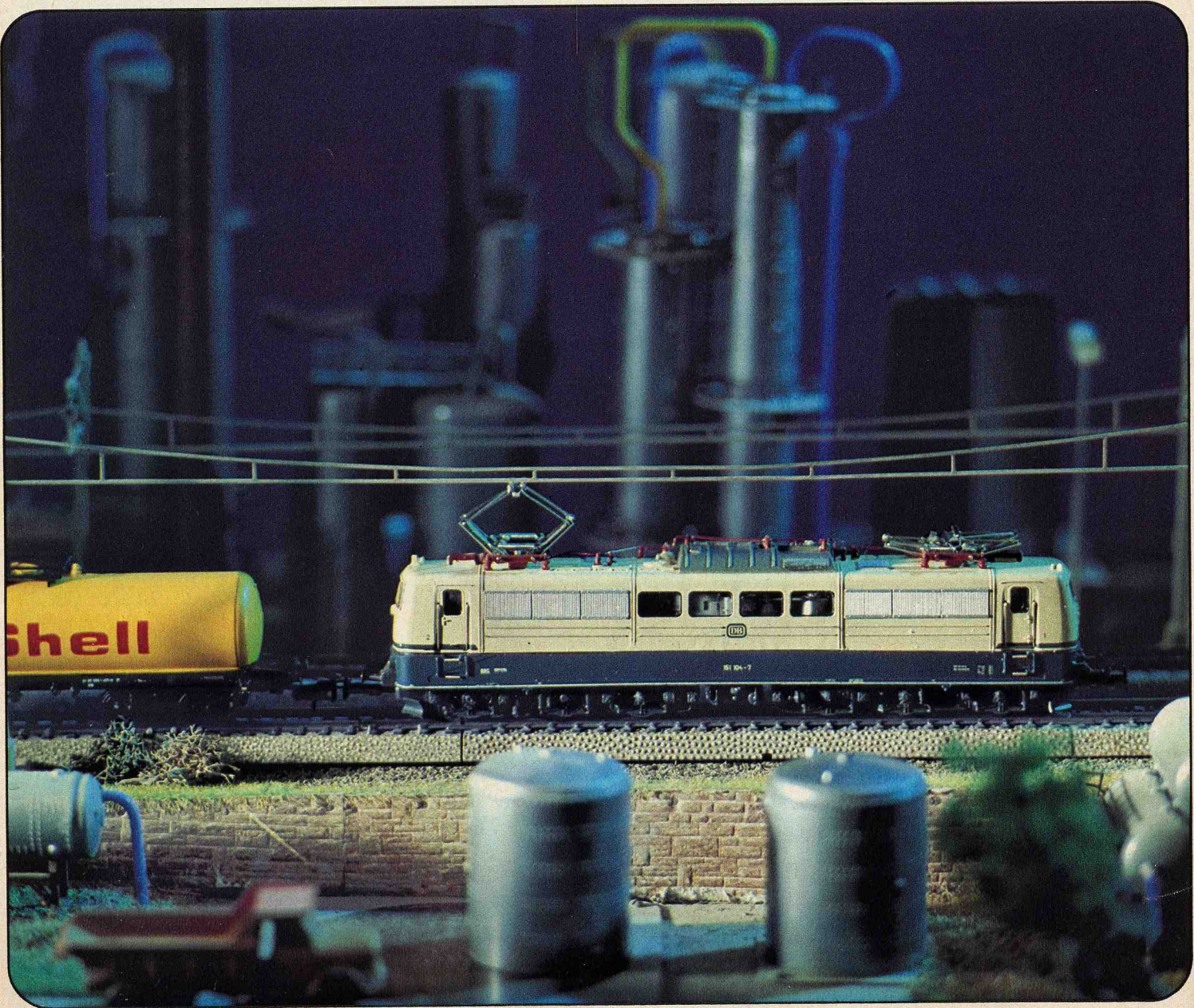
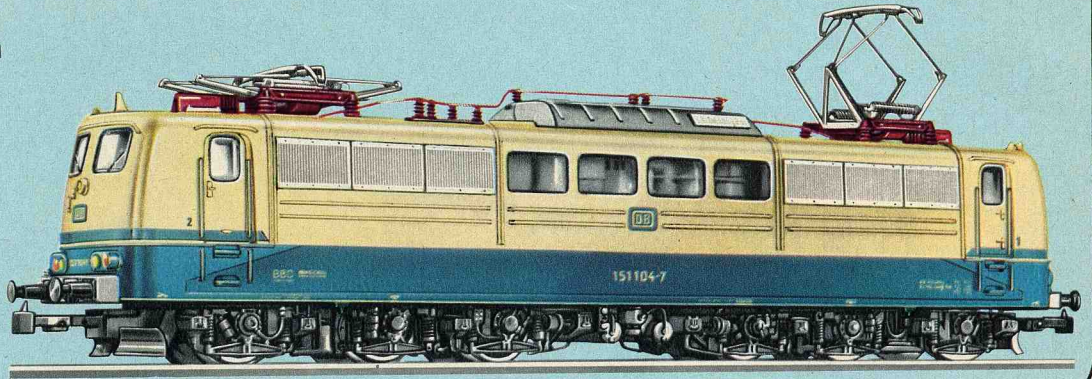

Express locomotive "103"

3054

Electric express locomotive · A model of the German Federal Railways' C-C class 103 locomotive · 3 driven axles · 4 non-skid tires · Remote control for forward and reverse drive · 3 working headlights at each end · Lever for selecting operation by overhead line or track supply · Die cast zinc frame · Specially low center of gravity · Plastic body in the TEE colors, beige and red · Aluminum-colored roof superstructure · Windows inset in plastic frames · 2 spring loaded pantographs on the roof · Coupling hook at each end · Length over buffers 21.9 cm

⊕ = 7153 ⊖ = 7164 ⚡ = 60015

This is the strongest, fastest and most elegant electric express train in service with German Federal Railways at this time. It is 19.50 m long and has 6 motors driving 6 axles. With its almost 9000 HP hourly rating, its working weight of 112 tons and its mighty tractive force on starting of

32 000 kg, it caters for future requirements. On suitable tracks, expresses pulled by the "103" travel at maximum speeds of 200 km/h. All the splendid features of the original are captured in the small Märklin model.



"194" heavy electric freight locomotive

3022

Electric freight locomotive · A model of the German Federal Railways' C-C class 194 locomotive · 3 driven axles · 4 non-skid tires · Remote control for forward and reverse drive · 3 working headlights at each end · Lever for selecting operation by overhead line or track supply · 2 spring loaded pantographs on roof · Green three-section metal body · Silver-colored roof · Windows inset with plastic frames · Automatic coupling with advance uncoupler (RELEX) at each end · Length over buffers 21 cm

⊕ = 7153 ⊖ = 7164 ⚡ = 60015

The class 194 locomotive is a heavyweight. The 6 motors give a starting power of about 6350 HP. At a total weight of 120 tons the machine has a maximum starting tractive force of 40 tons. Although its max-

imum speed is only 90 km/h, it is perfectly capable of tackling any gradient, even with the heaviest freight train. 124 of these 18.60 m long giants are in service with the German Federal Railways.

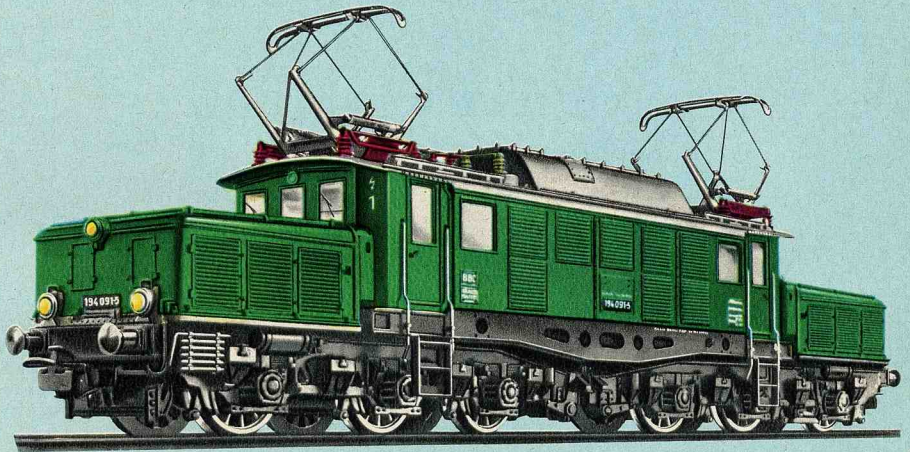

French high power electric locomotive

3038

Electric locomotive · A model of the Société Nationale des Chemins de Fer Français (SNCF) B-B class BB 9200 locomotive · 2 driven axles · 4 non-skid tires · Remote control for forward and reverse drive · 2 working headlights at each end · Lever for selecting operation by overhead line or track supply · 2 spring-loaded pantographs on roof · Turquoise metal body · Coupling hook with advance uncoupler at each end · Length over buffers 18 cm

⊕ = 7153 ⊖ = 7164 ⚡ = 60015

The French original of our model 3038 runs on certain stretches of the French Railways at a maximum speed of 160 km/h. The class BB 9200 locomotives have 4 motors developing a total of 5500 HP hourly rating. Their weight is 80 tons.



Swedish electric locomotive

3030

Electric locomotive · A model of the Swedish State Railways' (SJ) 2-8-2 class Da locomotive · 3 driven axles · Jackshaft driven through gears · 2 non-skid tires · Remote control for forward and reverse drive · 3 working headlights at each end · Lever for selecting operation by overhead line or track supply · 2 spring-loaded pantographs on roof · Brown metal body · Die cast zinc frame · Automatic coupling with advance uncoupler (RELEX) at each end · Length over buffers 14.7 cm

⊖ = 7153 ⊞ = 7185 ⚡ = 60015

The class Da is used on the Swedish State Railways (Statens Järnvägar) as the standard electric locomotive for passenger and freight service. Since these machines have only one motor and the low axle load of 15 or 17 tons, they are fitted with main driving rods so that individual wheels do not "run away" on starting.

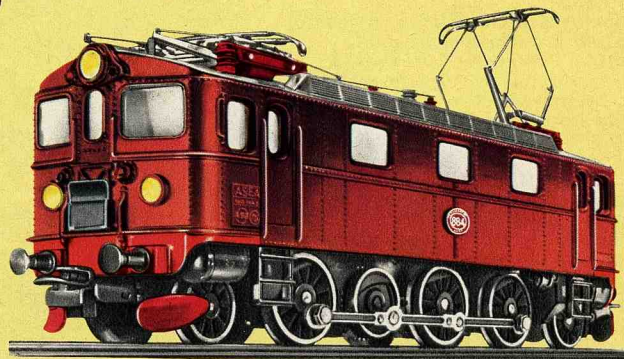

Interesting Swedish multi-purpose locomotive

3043

Electric multi-purpose locomotive · A model of the Swedish State Railways' (SJ) B-B class Rc locomotive · 2 driven axles · 4 non-skid tires · Remote control for forward and reverse drive · 4 working headlights at each end · Lever for selecting operation by overhead line or track supply · Orange plastic body · Windows inset in plastic frames · 2 spring-loaded pantographs on roof · Die cast zinc frame · Coupling hook at each end · Length over buffers 17.5 cm

⊖ = 7153 ⊞ = 7164 ⚡ = 60015

In these machines of very advanced design, the 16 2/3 Hz alternating current supply from the overhead line is converted by thyristors into direct current, which drives the four motors, developing a power of almost 5000 HP. The machine weighs 76 tons and can reach a speed of 135 km/h. It is almost 15.50 m long.

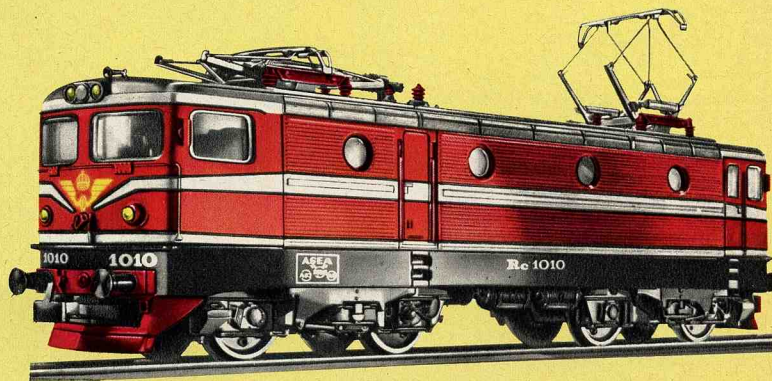

The Swiss Federal Railways' powerful multi-purpose locomotive

3050

Multi-purpose electric locomotive · A model of the Swiss Federal Railways' (SBB) C-C class Ae 6/6 locomotive · 3 driven axles · 4 non-skid tires · Remote control for forward and reverse drive · 3 working headlights at each end · Lever for selecting operation by overhead line or track supply · 2 spring-loaded pantographs on roof · Green metal body · Silver-colored roof · Locomotives has crest of Berne Canton · Coupling hook at each end · Length 20 cm · Crests of the other Swiss cantons are supplied with this locomotive

⊖ = 7153 ⊞ = 7164 ⚡ = 60015

The Swiss Federal Railways ordered the class Ae 6/6 for international passenger and freight express service. The locomotive's 120 tons weight and 6000 HP from six motors give it enormous starting and climbing power. The maximum speed is 125 km/h. For all its brute force, it is of particularly stylish appearance. That's why we have made an exact copy of it.

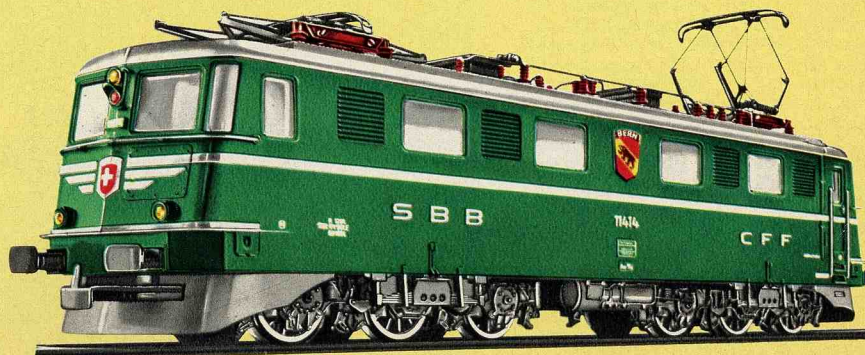



Swiss heavy freight locomotive "Crocodile"

3056 new

Electric freight locomotive
 A model of the Swiss Federal Railways' (SBB) 1C-C1 class Be 6/8^{III} locomotive · 3 driven axles · 4 non-skid tires · Because of its articulated construction it can easily negotiate curves of normal radius · Remote control for forward and reverse drive · 3 working headlights at each end · Lever for selecting operation by overhead line or track supply · 2 spring-loaded pantographs · Green plastic body · Windows inset in plastic frames · Automatic coupling with advance uncoupler (RELEX) at each end · Length over buffers 22.8 cm

⊙ = 7153 ⊞ = 7164 ⊚ = 60015

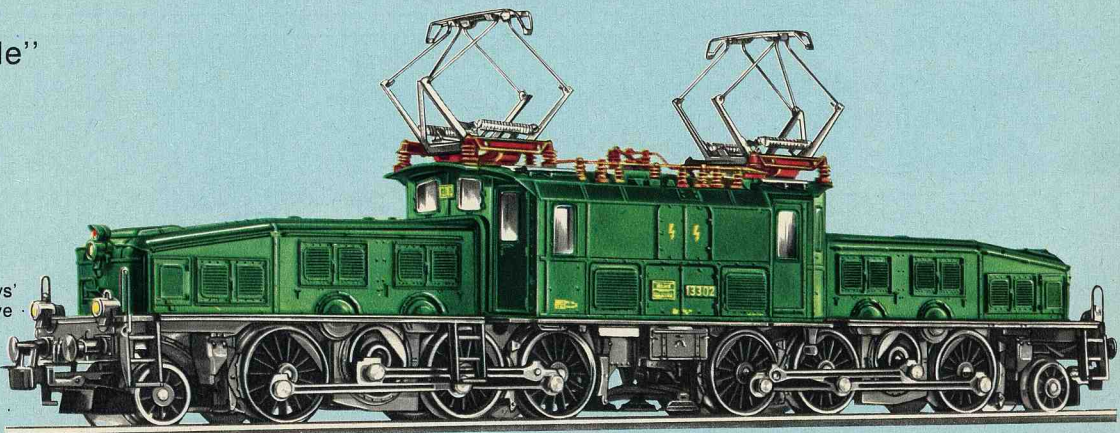



As a result of the growth in traffic on the Gotthard route, another 18 locomotives designated Be 6/8^{III} were put into service in 1926 and 1927. Like the class Ce 6/8 machines already in service, they became well-known under the nickname of "Crocodile" far beyond the frontiers of

Switzerland. With a length of 20.06 m and a motor power of 2460 HP, giving a maximum speed of 75 km/h, they were for many years one of the most impressive sights in the Swiss heavy freight train service.

Italian electric locomotive

3035

Electric locomotive · A model of the Italian State Railways' (FS) B-B class E 424 locomotive · 2 driven axles · 4 non-skid tires · Remote control for forward and reverse drive · 2 working headlights at each end · Lever for selecting operation by overhead line or track supply · 2 spring-loaded pantographs on roof · Brown metal body · Coupling hook with advance uncoupler at each end · Length over buffers 17.5 cm

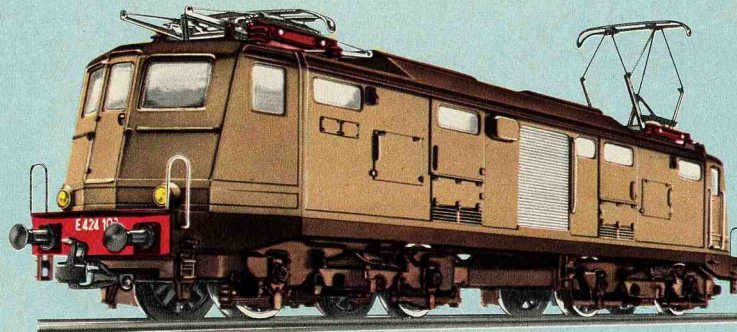

0 = 7153  = 7164  = 60015



Austrian Federal Railways' multi-purpose locomotive

3041

Multi-purpose electric locomotive · A model of the Austrian Federal Railways' (ÖBB) B-B class 1043 locomotive · 2 driven axles · 4 non-skid tires · Remote control for forward and reverse drive · 3 working headlights at each end · Lever for selecting operation by overhead line or track supply · Red plastic body · Windows inset in plastic frames · 2 single bar current-collectors on roof · Die cast zinc frame · Coupling hook at each end · Length over buffers 17.5 cm

0 = 7153  = 7164  = 60015





After extensive trials with this locomotive, which was built by the Swedish firm ASEA, the Austrian Federal Railways acquired four of them initially and put them into service with the designation class 1043. The 16 2/3 Hz alternating current supply

from the overhead line is converted to direct current by means of thyristors. The four motors develop almost 5000 HP, enabling the 77.4 ton, 15.5 m long locomotive to reach a maximum speed of 135 km/h.

Netherlands Railways' electric locomotive

3055

Electric locomotive · A model of the Netherlands Railways' (NS) C-C class 1200 locomotive · 3 driven axles · 4 non-skid tires · Remote control for forward and reverse drive · 3 working headlights at each end · Lever for selecting operation by overhead line or track supply · Gray and yellow metal body · 2 spring-loaded pantographs · Windows inset in plastic frames · Coupling hook at each end · Length over buffers 19.6 cm

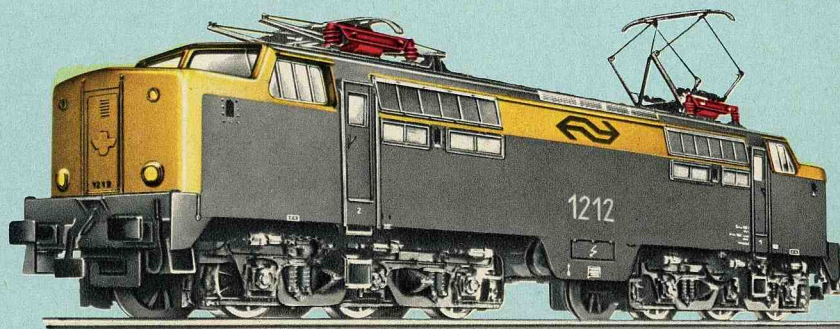

0 = 7154  = 7164  = 60015



Diesel-hydraulic locomotive "DHG 500"

3078

Diesel locomotive · A model of the 0-6-0 industrial locomotive known as the Type DHG 500 · 3 driven axles · 2 non-skid tires · Remote control for forward and reverse drive · 3 working headlights at each end · Blue plastic body with decorative silver-colored bands · Die cast zinc frame · Coupling hook at each end · Length over buffers 11.2 cm

○ = 7154  = 7185  = 60015

These "small" diesel locomotives with hydraulic transmissions are in fact at least 10-11 m long and they have several hundred horsepower under the hood. In particular, the heavily loaded gears are especially robust, so that these locomotives can be used for quite long periods without too much maintenance. The Märklin models 3078 and 3080, which are typical industrial locomotives, have windows in the lower corners of the front panel of the cab, which enable the engineer to have a clear view of the buffers and to position the locomotive accurately in switching operations.

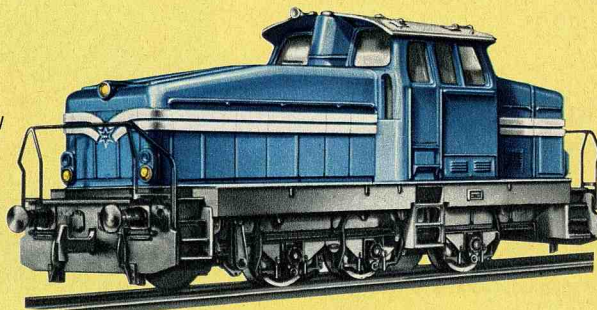

Industrial locomotive

3080

Diesel locomotive · A model of a 0-6-0 industrial locomotive · 3 driven axles · 2 non-skid tires · Remote control for forward and reverse drive · Yellow plastic body with dark decorative bands · Die cast zinc frame · Coupling hook at each end · Length over buffers 11.2 cm



○ = 7154  = 7185



Diesel-hydraulic switching locomotive "260" with Märklin TELEX coupling

3065 TELEX see page 14



Diesel locomotive · A model of the German Federal Railways' 0-6-0 class 260 locomotive · 3 driven axles · 2 non-skid tires · Remote control for forward and reverse drive · 3 working headlights at each end · Red plastic body · Windows inset in plastic frames · Die cast zinc frame · Märklin TELEX coupling at each end · Length over buffers 12 cm

○ = 7153  = 7185  = 60010

with coupling hooks

3064

Diesel locomotive · A model of the German Federal Railways class 260 · Like 3065, but **without** the Märklin TELEX coupling · Coupling hook with advance uncoupler at each end

○ = 7153  = 7185  = 60010

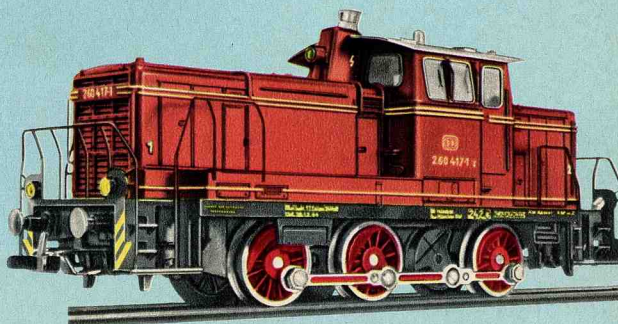



Diesel-hydraulic locomotive "212"

3072

Diesel locomotive · A model of the German Federal Railways' B-B class 212 locomotive · 2 driven axles · 4 non-skid tires · Remote control for forward and reverse drive · 3 working headlights at each end · Die cast zinc frame · Red plastic body · Narrow front and rear ends to scale · Windows inset in plastic frames · Automatic coupling with advance uncoupler (RELEX) at each end · Length over buffers 14.1 cm · A suitable positioning

The 212 is a multi-purpose diesel locomotive with a working weight of 63.2 tons and a length of over 12 m. The new types develop 1350 HP, which is transmitted by means of cardan shafts to the 4 axles arranged in 2 trucks.

of the motor in model 3072 has enabled the front and rear end superstructure to be kept narrow as on the original

○ = 7154  = 7164  = 60010

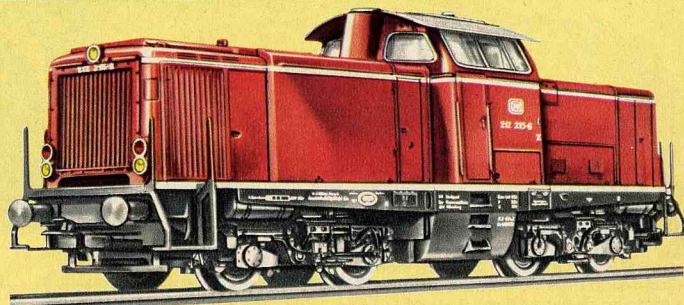

To suit the tractive force of the powerful motor to the requirements of passenger and freight traffic, a two-speed gearbox is used. The gear ratio must be selected when the locomotive

is stationary. In low gear the locomotive exerts its maximum tractive force, but has a maximum speed of only 65 km/h, while in high gear it reaches 100 km/h.

**Diesel-hydraulic
express locomotive
"220"**

3021

Diesel locomotive · A model of the German Federal Railways B-B class 220 locomotive · 2 driven axles · 4 non-skid tires · Remote control for forward and reverse drive · 3 working headlights at each end · Red and gray metal body · Silvery-gray roof · Coupling hook with advance uncoupler at each end · Length over buffers 21 cm



0 = 7154  = 7183  = 60010



Diesel locomotive "216"

3074

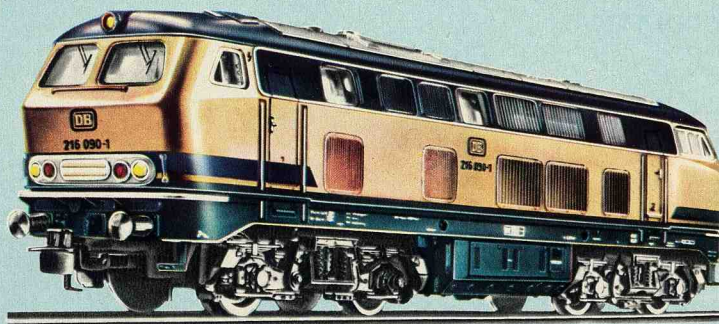

Diesel locomotive · A model of the German Federal Railways' B-B class 216 locomotive · 2 driven axles · 4 non-skid tires · Remote control for forward and reverse drive · 3 working headlights at each end · Turquoise and beige plastic body · Windows inset in plastic frames · Simulated windshield wipers · Die cast zinc frame · Automatic coupling with advance uncoupler (RELEX) at each end · Length over buffers 18.2 cm

0 = 7154  = 7164  = 60015



3075

Diesel locomotive · A model of the German Federal Railways' class 216 · Similar to 3074, but with a red and gray body

0 = 7154  = 7164  = 60015

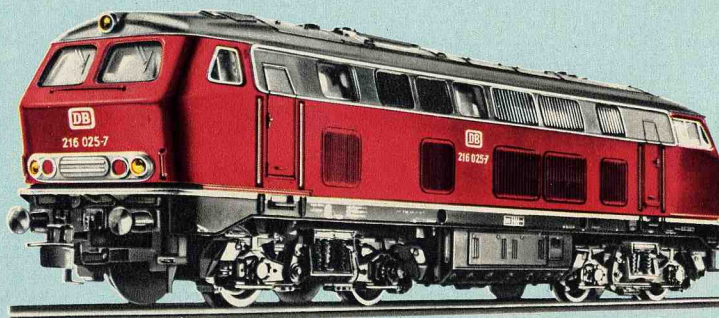

The class 216 diesel locomotive is used for mainline duty over medium distances. The working weight with full fuel tanks is 79 tons. It develops 1900 HP, giving a maximum speed of 120 km/h.



**Belgian State Railways'
multi-purpose
diesel locomotive**

3066

Diesel locomotive · A model of the Belgian State Railways' (NMBS/SNCB) C-C Type 204 locomotive · 3 driven axles · 4 non-skid tires · Remote control for forward and reverse drive · 3 working headlights at each end · Green metal body · Black roof · Windows inset in plastic frames · Coupling hook at each end · Length over buffers 20.5 cm

0 = 7154  = 7164  = 60015



The Belgian multi-purpose diesel locomotive type 204 has diesel-electric drive. It is used for local and express passenger trains as well as for light freight trains, and its 1750 HP give it a maximum speed of 140 km/h.

USA-“F7” diesel locomotive of the Rio Grande Railway Company



3062 new

Diesel locomotive · A model of the Rio Grande Railway Company version of the American B-B Type F7 locomotive made by the Electro-Motive Division of General Motors · 2 driven axles · 4 non-skid tires · Remote control for forward and reverse drive · Lights as on original · Metal body

in black, yellow, green and aluminum color scheme · Coupling hook with advance uncoupler at engineer's cab · Automatic coupling with advance uncoupler (RELEX) at rear end · Length 17.5 cm

⊖ = 7154 ⚙ = 7185 ⚡ = 60015

4062 new

Supplementary section, unpowered · Matching diesel locomotive 3062 · Lights as on original · Metal body · Coupling hook with advance uncoupler at engineer's cab end · Length 17.5 cm

⚙ = 7185 ⚡ = 60015



USA-“F7” diesel locomotive of the Atchison Topeka and Santa Fé Railway

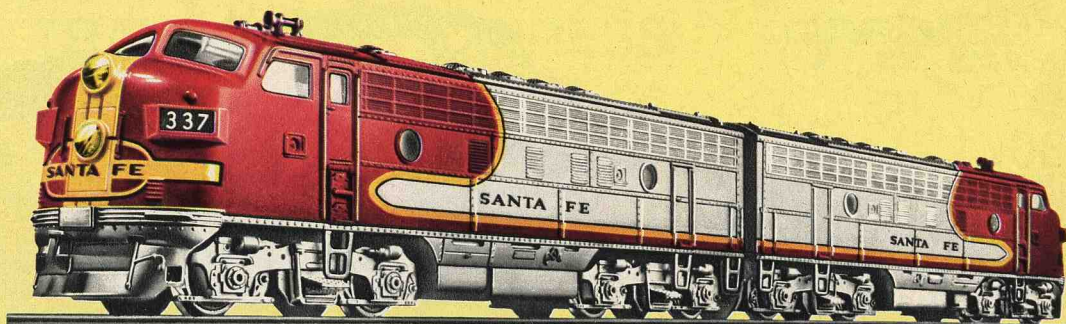

3060

Diesel locomotive · A model of the Atchison Topeka and Santa Fé Railway version of the American B-B Type F7 locomotive made by the Electro-Motive Division of General Motors · 2 driven axles · 4 non-skid tires · Remote control for forward and reverse drive · Lights as on original · Red and silver colored metal body

Coupling hook with advance uncoupler at cab end · Automatic coupling with advance uncoupler (RELEX) at rear end · Length 17.5 cm

⊖ = 7154 ⚙ = 7185 ⚡ = 60015

4060

Supplementary section, unpowered · Matching diesel locomotive 3060 · Lights as on original · Red and silver-colored metal body · Coupling hook with advance uncoupler at engineer's cab end · Length 17.5 cm

⚙ = 7185 ⚡ = 60015

Danish State Railways diesel-electric locomotive

3067

Diesel locomotive · A model of the Danish State Railways' (DSB) A1A-A1A Type My 1100 locomotive · 3 driven axles · 4 non-skid tires · Remote control for forward and reverse drive · 3 working head-lights at each end · Black and red metal body · Gray roof · Windows inset in plastic frames · Coupling hook at each end · Length over buffers 20.5 cm

⊙ = 7154 🚂 = 7164 🚗 = 60015



The Danish State Railways' Class My 1100 multi-purpose locomotives have diesel-electric drive. With this system, electric motors on the axles are provided with current from generators which in turn are driven by diesel motors. This locomotive is very similar to the Belgian Type 204.

Norwegian State Railways' multi-purpose diesel-electric locomotive

3068

Diesel locomotive · A model of the Norwegian State Railways' (NSB) C-C Type Di 3 locomotive · 3 driven axles · 4 non-skid tires · Remote control for forward and reverse drive · 3 working head-lights at each end · Red and brown metal body · Silver-colored · Roof and roof fittings · Windows inset in plastic frames · Coupling hook at each end · Length over buffers 20.5 cm

⊙ = 7154 🚂 = 7164 🚗 = 60015



Diesel traction is being used increasingly on those sections of the Norwegian State Railways which are not already electrified. The original of our model locomotive is known as the Type Di 3. With its 1900 HP motor it can reach a maximum speed of

100 km/h. Apart from the roof fittings the relationship with the Belgian Type 204 and the Danish Type My 1100 is unmistakable.

"TEE" high speed railcar

3071

TEE high speed railcar in three parts · A model of the Netherlands-Swiss TRANS-EUROPE-EXPRESS train, consisting of a locomotive, a combined first class and dining car and a spacious first-class compartment car with engineer's section · Length of model 70 cm

Locomotive: 3 driven axles · 4 non-skid tires · Remote control for forward and reverse drive · Mat black die cast zinc frame · Plastic body in the TEE colors, beige and red · Gray roof · Windows inset in plastic frames

Dining car and engineer's car: Each with 2 accurately reproduced trucks · Plastic body in the TEE colors, beige and red · Gray roof · Windows inset in plastic frames



Special couplings connect the 3 units very closely together · The walkways between the cars have specially tightly closing covers · At each end of the train there are three headlights and two red taillights, which operate in accordance with the direction of motion · A current pick-up shoe

at each end of the train, the leading one always collecting the current

⊙ = 7154 🚂 = 7164 🚗 = 60015 w
🚗 = 7175 🚗 = 60001 r

**Railbus
with trailer**

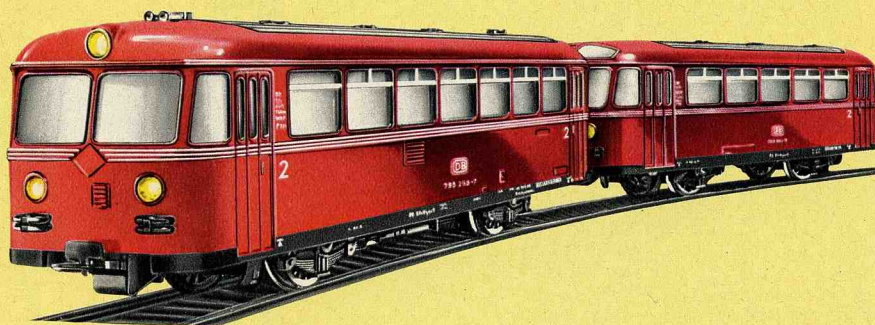

3016

Railbus · A model of the German Federal Railways' 795 unit · 1 driven axle · 2 non-skid tires · Remote control for forward and reverse drive · 3 working headlights at each end · Interior lighting · Red plastic body · Die cast zinc frame · Special symmetrical couplings at each end for coupling the cars together tightly · Length over buffers 14.7 cm

⊙ = 7153 ⊞ = 7164 ⚡ = 60010

4018

Railbus trailer · A model of the German Federal Railways 995 unit · Red taillights operate at either end · Interior lighting · Red plastic body · Special symmetrical

coupling, to fit railbus only · Length over buffers 12 cm

⊞ = 7175 ⚡ = 60010

Rail Zeppelin

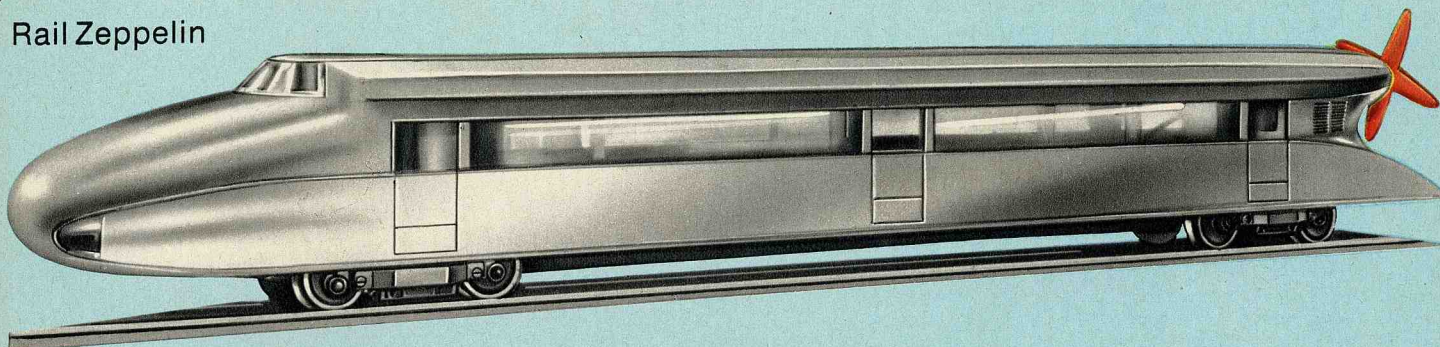

3077

Rail Zeppelin based on Kruckenberg's system · 4 axles · 2 driven axles · 4 non-skid tires · Remote control for forward and reverse drive · As the traction voltage is

slowly increased from 4 V, first the propeller spins up, driven by a special motor, and then the locomotive starts to roll · 2 working headlights · Silver-gray plastic body · Fitted windows with simulated struts · Die cast zinc frame · Length 28.8 cm

⊙ = 7154 ⊞ = 7164 ⚡ = 60015

The Rail Zeppelin, built for the Flugbahn-GmbH from Franz Kruckenberg's design, attained the world record speed of 230 km/h during reliability test runs in 1931. The drive was obtained from a 600 HP BMW aircraft engine at the rear of the vehicle, acting through the propeller.

TRANS EUROP EXPRESS



4071

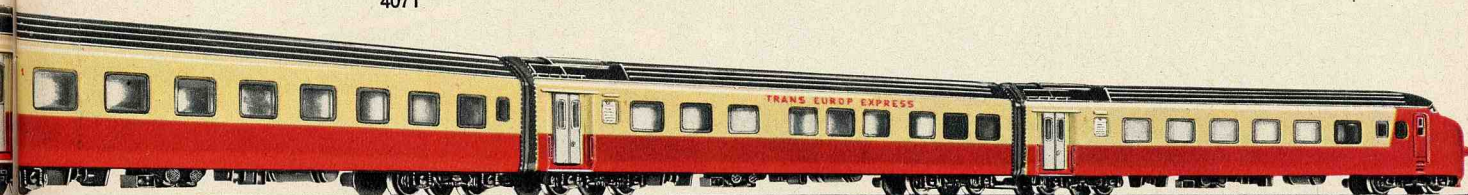

4071

TEE compartment coach · 1st class · 2 four-wheel trucks true to the original · Gray roof · Windows inset in plastic frames · Flexible covers for the walkways between cars at each end · Special coupling fitting TEE trains only · Length 23.3 cm

The Netherlands-Swiss TRANS-EUROP-EXPRESS operated 5 trains on the Zürich-Amsterdam route as the TEE "Edelweiss". They usually consisted of 4 cars. Three powerful diesel motors developing a total of 2300 HP gave the train a speed of 140 km/h. Windows could not be opened in this train, as every car was fully air-conditioned. As in all TEE trains, there were

only 1st class coaches, containing 114 seats. The dining car section could seat 32.

The TEE train illustrated consists of the three-part unit 3071 together with the supplementary car 4071, giving the usual four-car composition. Length of the 4 unit train is 93.5 cm.

TEE coaches and local passenger service cars with interior fittings 24 cm

TEE coaches with interior fittings

4085

TEE compartment car · 1st class · A model of the German Federal Railways' type Avm · Windows inset in plastic frames · **Interior fittings** with

side corridor · Length 24 cm · This car can be fitted with the interior lighting set 7320 (see page 46)

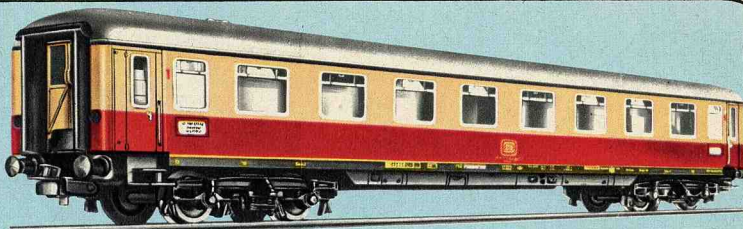

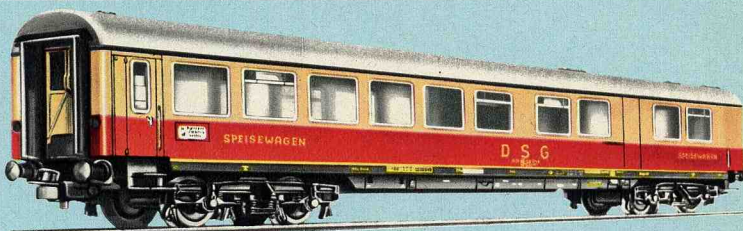

4087

TEE dining car · A model of the German Federal Railways' type WRm · Windows inset in plastic frames · **Interior fittings**, divided into kitchen and dining sections · Length 24 cm · This car can be fitted with the interior lighting set 7320 (see page 46)



4089

TEE compartment car · Similar to car 4085, but with current pick-up, wiring for interior lighting and tail-lights

 = 7175  = 60015

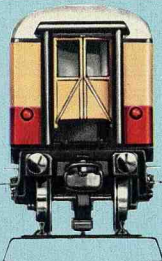

The TEE coaches are the show pieces of the German Federal Railways, being the best equipped, the most comfortable and certainly the most stylish cars in the Federal Railways service.

4090

TEE dome car · 1st class · A model of the German Federal Railways' type ADm · Windows inset in plastic frames · **Interior fittings** · Transparent plastic dome · Length 24 cm · This car can be fitted with the interior lighting set 7322 (see page 46)

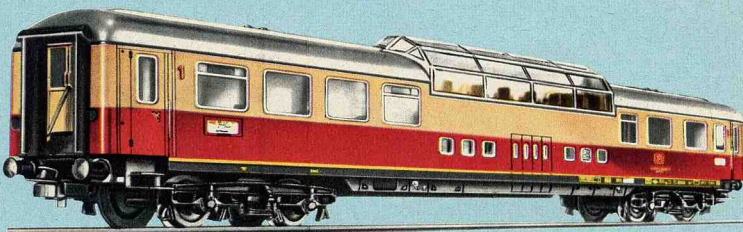



German Federal Railways' local passenger service cars with interior fittings

4077

Local passenger service car with baggage compartment and en-

gineer's cab · 2nd class · A model of the German Federal Railways' type BDnf · Car body stainless steel-colored with peacock's eye pattern · **Interior fittings** · Windows with plastic frames · Dummy hooter on roof · Headlights at the cab end · Length 24 cm · This car can be fitted with the interior lighting set 7077 (see page 46)

 = 7175  = 60000



4082

Local passenger service car · 2nd class · A model of the German Federal Railways' type Bnb · Car body stainless steel-colored with peacock's eye pattern · **Interior fittings** · Windows with plastic frames

Length 24 cm · This car can be fitted with interior lighting set 7077 and current pick-up shoe 7198 (see page 46)



4083

Local passenger service car · 1st and 2nd class · A model of the German Federal Railways' type ABnb · Car body stainless steel-colored with peacock's eye pattern · **Interior fittings** · Windows with plastic frames

Length 24 cm · This car can be fitted with interior lighting set 7077 and current pick-up shoe 7198 (see page 46)



Express coaches with interior fittings 24 cm

German Federal Railways' express coaches

4111 **new**

Express coach · 1st class · A model of the German Federal Railways' type A üm · **Interior fittings** · Windows inset in plastic frames · Length 24 cm · This car can be fitted with interior lighting set 7077 and current pick-up shoe 7198 (see page 46)



The bodies of our express cars are made of metal or plastic, with inset plastic window frames and panes. Door bays and other important details and the tiny indelible lettering are modeled exactly on the original. The mat finish makes the cars look completely realistic. Everything is prepared for the installation of interior lighting. The simulated Minden-Deutz type trucks have movable side plates which compensate for irregularities in the track and permit a safe and quiet ride. Simulated rubber beading or bellows are fitted where the cars are connected together. Automatic coupling with advance uncoupler (RELEX).

4112 **new**

Express coach · 2nd class · A model of the German Federal Railways' type B üm · **Interior fittings** · Windows inset in plastic frames · Length 24 cm · This car can be fitted with interior lighting set 7077 and current pick-up shoe 7198 (see page 46)

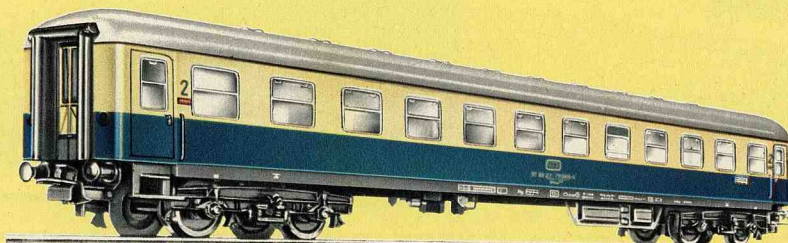

4026

Express baggage car · A model of the German Federal Railways' type D üm · Windows inset in plastic frames · Length 24 cm · This car can be fitted with interior lighting set 7077 and current pick-up shoe 7198 (see page 46)





4051

Express coach · 1st class · A model of the German Federal Railways' type A üm · **Interior fittings** · Windows inset in plastic frames · Length 24 cm · This car can be fitted with interior lighting set 7077 and current pick-up shoe 7198 (see page 46)



Express coach · Similar to 4051, but with taillights and current pick-up shoe

 = 7175  = 60015

4053



4052

Express coach · 2nd class · A model of the German Federal Railways' type B üm · **Interior fittings** · Windows inset in plastic frames · Length 24 cm · This car can be fitted with interior lighting set 7077 and current pick-up shoe 7198 (see page 46)

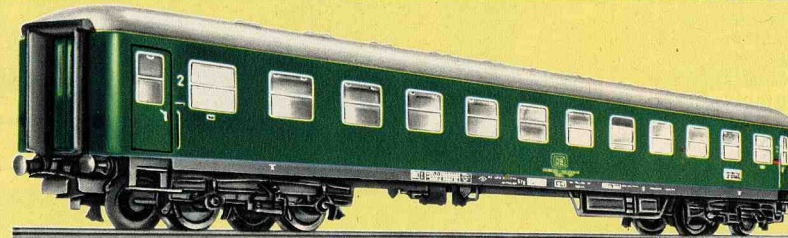

4054

Express dining car · A model of the German Federal Railways' type WR üm¹³² · **Interior fittings**, divided into kitchen and dining sections · Windows inset in plastic frames · Length 24 cm · This car can be fitted with interior lighting set 7320 (see page 46)





The express and local passenger service cars on pages 30/31 are equipped with automatic coupling and advance uncouplers (RELEX).

4029

Express sleeping car · A model of the International Sleeping Car Co.'s type ISG No. 4581 · Windows inset in plastic frames · Length 24 cm · This car can be fitted with interior lighting set 7077 and current pick-up shoe 7198 (see page 46)

German Federal Railways' express coaches

4037

Express coach · 2nd class, one of the older designs · A model of a type used by German Federal Railways · Windows with "cellon" panes · Length 22 cm · This car can be fitted with interior lighting set 7077 and current pick-up shoe 7198 (see page 46)

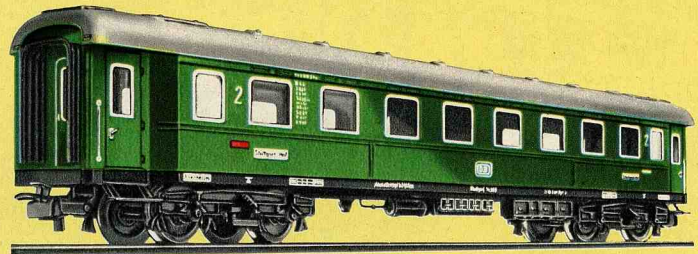

4064

Express sleeping car · 1st and 2nd class · A model of the German Sleeping and Diner Car Co.'s (DSG) WL AB um Series 33 200 · Windows inset in plastic frames · Length 24 cm · This car can be fitted with interior lighting set 7320 (see page 46)

Light weight express coaches of the Swiss Federal Railways

4066

Passenger car · A model of the Swiss Federal Railways' Series A 2500 1st class coach · Windows inset in plastic frames · Roof with longitudinal ribs and imitation ventilators · Length 24 cm · This car can be fitted with interior lighting set 7320 (see page 46)

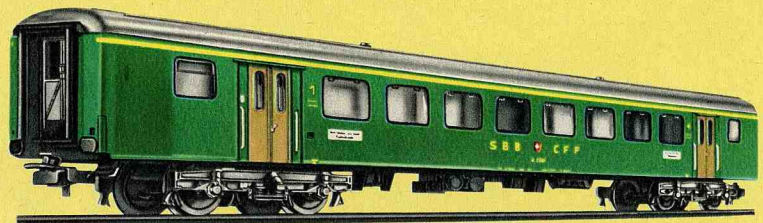

4068

Express dining car · A model of the Swiss Federal Railways' type RIC dining car · Windows inset in plastic frames · Screwed-on roof with longitudinal ribs · Single bar current collector on roof · Length 24 cm · This car can be fitted with interior lighting set 7077 (see page 46)



Interior fittings for coaches 4037, 4045 and 4066

0225

Set of interior fittings for the express coaches, with 18 single-colored double seats, 6 single seats and 2 rest rooms

Interior fittings and figures are made in finely detailed plastic, the figures being hand-painted. Illustrated installation instructions are included with every set.

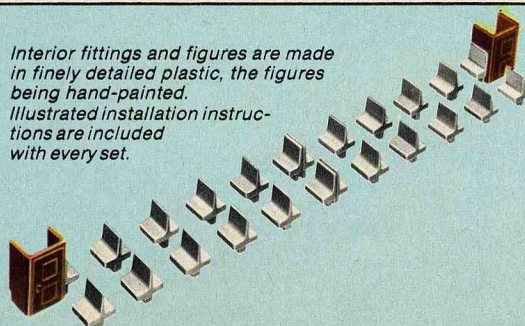

0226

Pack with 10 realistically-colored figures to supplement the interior fittings

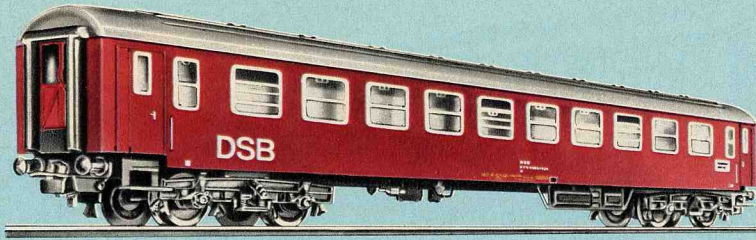

Danish State Railways' express coach
4045

Express coach · 2nd class · A model of the Danish State Railways' (DSB) type B 2300 · Windows inset in plastic frames · Length 24 cm · This car can be fitted with interior lighting set 7077 and current pick-up shoe 7198 (see page 46)

Netherlands Railways' express passenger coach
4049

Express passenger coach · 2nd class · A model of the Netherlands Railways' type B 6600 · Windows inset in plastic frames · Length 24 cm · This car can be fitted with interior lighting set 7320 (see page 46)



Italian State Railways' express coach
4063

Express coach · 1st class · A model of the Italian State Railways' type FS Az · **Interior fittings** · Windows inset in plastic frames · Length 24 cm · This car can be fitted with the interior lighting set 7077 and current pick-up shoe 7198 (see page 46)

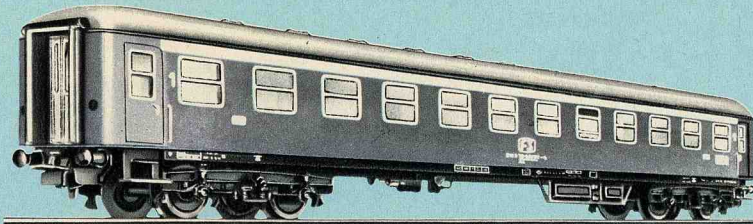

Swedish State Railways' express coaches

4072

Express coach · 2nd class · A model of the Swedish State Railways' type Bo 1 · Plastic car body · Windows inset in plastic frames · Length 23.7 cm · This car can be fitted with interior lighting set 7197 (see page 46)

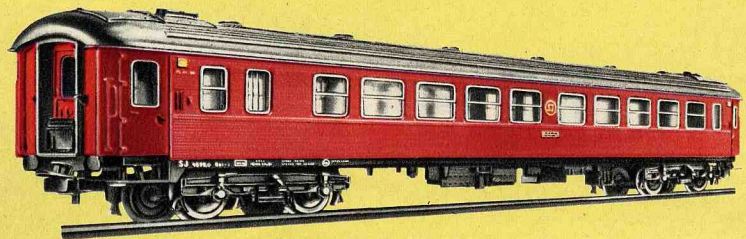

4073

Express dining car · A model of the Swedish State Railways' type RBo 2 · Plastic car body · Windows inset in plastic frames · Length 23.7 cm · This car can be fitted with interior lighting set 7197 (see page 46)

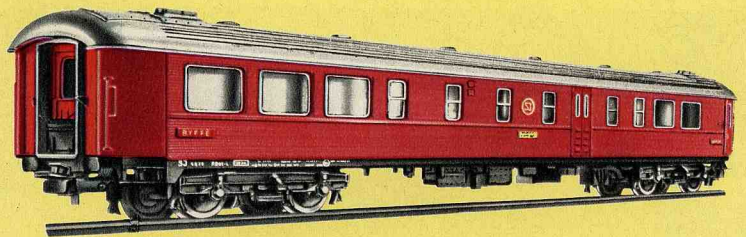

French State Railways' express coach
4076

Express coach · 1st class · A model of the SNCF's stainless steel type A8myfi · Plastic body · **Interior fittings** · Windows inset in plastic frames · Length 24 cm · This car can be fitted with interior lighting set 7197 (see page 46)



TEE coaches with interior fittings 27 cm

4095

TEE compartment car · 1st class · A model of the German Federal Railways' type Avm · Plastic car body · **Interior fittings** with side corridor · Windows inset in plastic frames · Length 27 cm · This car can be fitted with interior lighting set 7325 (see page 46)

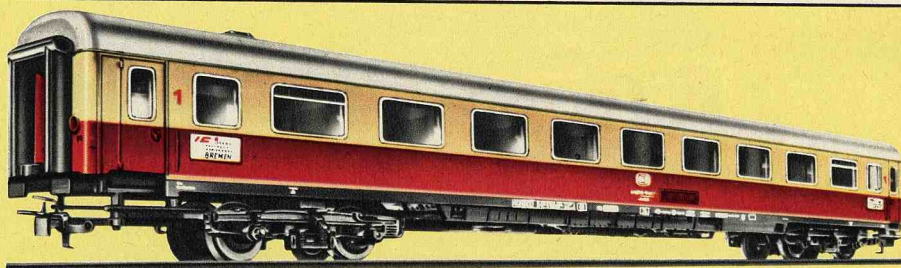

4096

TEE open-interior coach · 1st class · A model of the German Federal Railway's type Apm · Plastic car body · **Interior fittings**, seats arranged in one single and one double row separated by gangway · Windows inset in plastic frames · Length 27 cm · This car can be fitted with interior lighting set 7325 (see page 46)

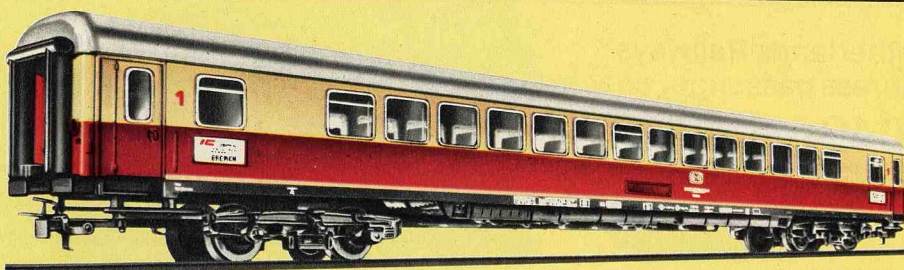

4097

TEE dining car · A model of the German Federal Railways' type WRm · Plastic car body · **Interior fittings**, divided into kitchen and dining sections · Windows inset in plastic frames · Length 27 cm · This car can be fitted with interior lighting set 7325 (see page 46)

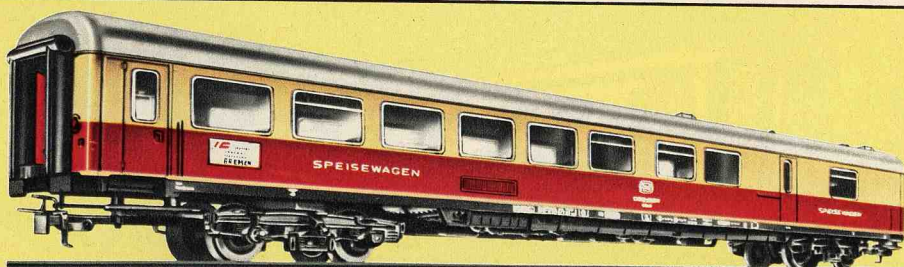

4099

TEE dome car · 1st class · A model of the German Federal Railways' type ADm · Plastic car body · **Interior fittings**, divided into bar, seating compartment and raised row of seats · Transparent plastic observation dome · Windows inset in plastic frames · Length 27 cm · This car can be fitted with interior lighting set 7325 (see page 46)

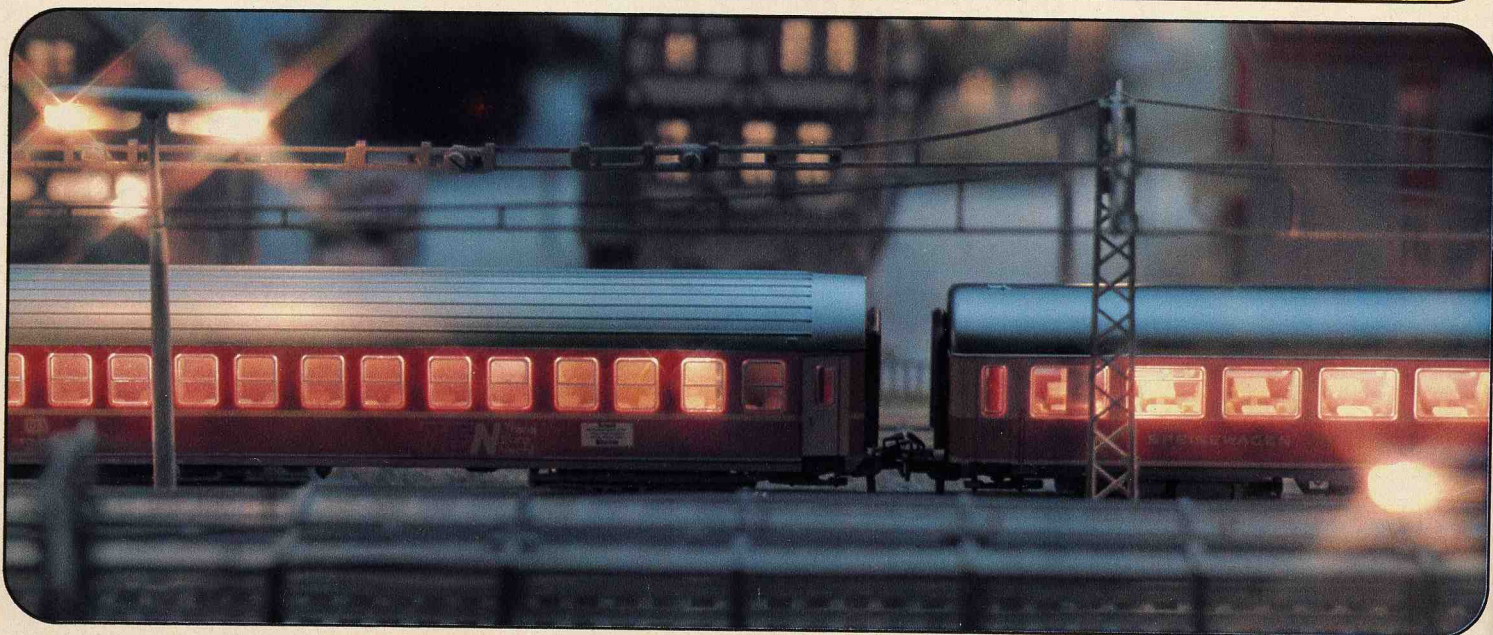

Express coaches with interior fittings 27 cm

4150 **new**

Express sleeping car · 1st and 2nd class · A model of the German Federal Railways' type WLABsm in the TEN version · Plastic car body · **Interior fittings** · Windows inset in plastic frames · Length 27 cm · This car can be fitted with interior lighting set 7325 (see page 46)



4091

Express coach · 1st class · A model of the German Federal Railways' type A üm²⁰¹ · Plastic car body · **Interior fittings** · Windows inset in plastic frames · Length 27 cm · This car can be fitted with interior lighting sets 7324 or 7325 (see page 46)

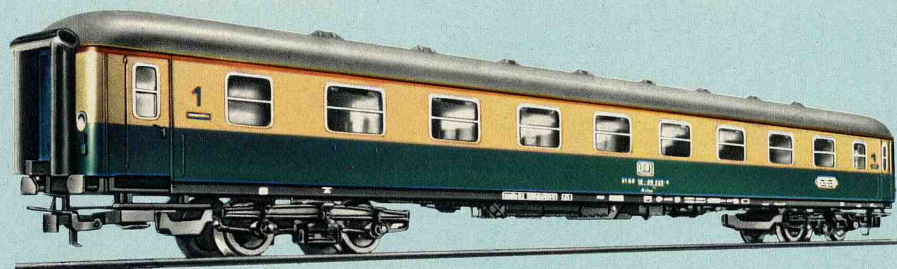

4092

Express coach · 2nd class · A model of the German Federal Railways' type B üm²³⁴ · Plastic car body · **Interior fittings** · Windows inset in plastic frames · Length 27 cm · This car can be fitted with interior lighting sets 7324 or 7325 (see page 46)

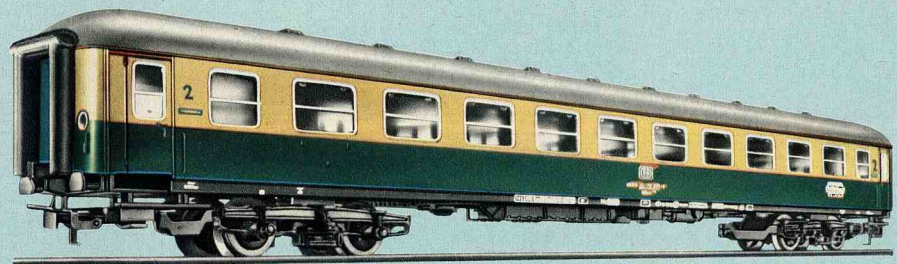

4093

Express baggage car · A model of the German Federal Railways' type D üm³⁰² · Plastic car body · **Moveable roller shutters** on each side · Windows inset in plastic frames · Length 27 cm · This car can be fitted with interior lighting sets 7324 or 7325 (see page 46)



4094

Express dining car · A model of the German Federal Railways' type WR ümh¹³² · Plastic car body · **Interior fittings**, divided into kitchen and dining sections · Windows inset in plastic frames · Length 27 cm · This car can be fitted with interior lighting sets 7324 or 7325 (see page 46)





4000

Local service coach · Platform and entrance at each end · Unglazed windows · Length 11.5 cm

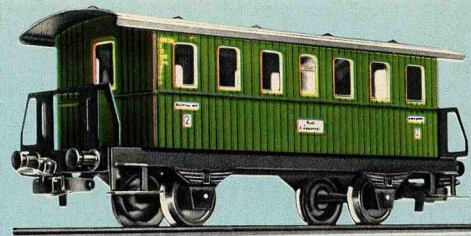

4040

Local service coach · Platform and entrance at each end · Unglazed windows · Length 11.5 cm

Local service coaches with automatic coupling and advance uncouplers (RELEX, see page 38)

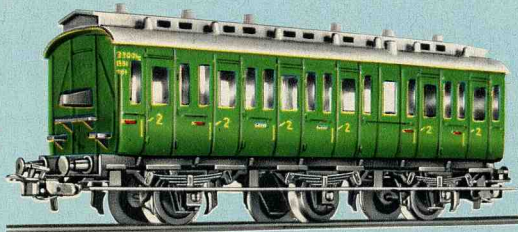

4004

Compartment car without brakeman's cab · Car sides divided into 6 compartments · Windows glazed with "cellon" panes · Length 13 cm · This car can be fitted with interior lighting set 7074 (see page 46)

4005

Compartment car with brakeman's cab · Car sides divided into 6 compartments · Windows glazed with "cellon" panes · Length 13 cm · This car can be fitted with interior lighting set 7074 (see page 46)

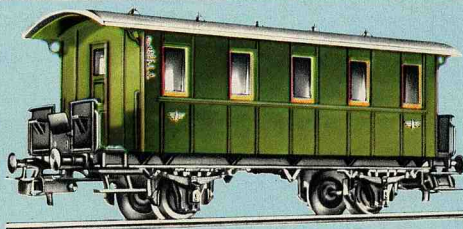
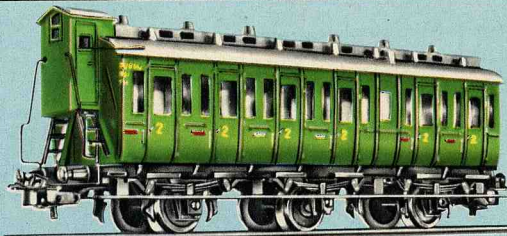

4007

Local service coach · Modeled on a private railroad coach · Platform and entrance at each end · Plastic car body · Imitation ventilators on roof · Windows inset in plastic frames · **Interior fittings** · Length 11 cm · This car can be fitted with interior lighting set 7323 (see page 46)

4008

Baggage car · Modeled on the type Pwi No. 0116911 Stgt · Platform and entrance at each end · Plastic car body · Imitation ventilators, superstructure for conductor's cab · Windows inset in plastic frames · Length 11 cm · This car can be fitted with interior lighting set 7323 (see page 46)

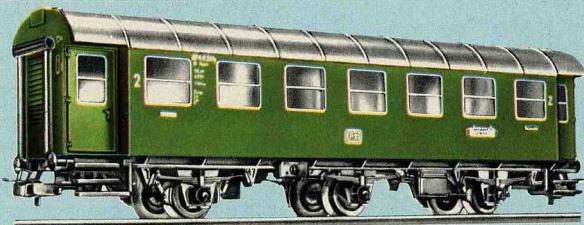
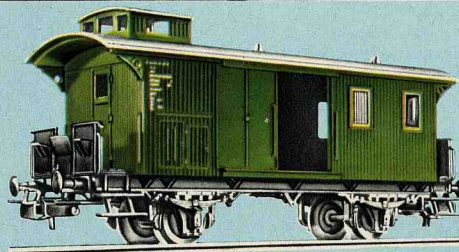

4079

Local service coach · A model of the German Federal Railways' type B3yge · Plastic car body · Windows inset in plastic frames · Simulated rubber beading · Length 15.2 cm · This car can be fitted with interior lighting set 7074 (see page 46)

4080

Local service coach with baggage compartment · A model of the German Federal Railways' type BD3yge · Plastic car body · Windows inset in plastic frames · Simulated rubber beading · Length 15.2 cm · This car can be fitted with interior lighting set 7074 (see page 46)





4074

Automobile rack car · A model of the German Federal Railways' type DDm 915 · With 8 WIKING miniature automobiles aboard · Length 26.4 cm

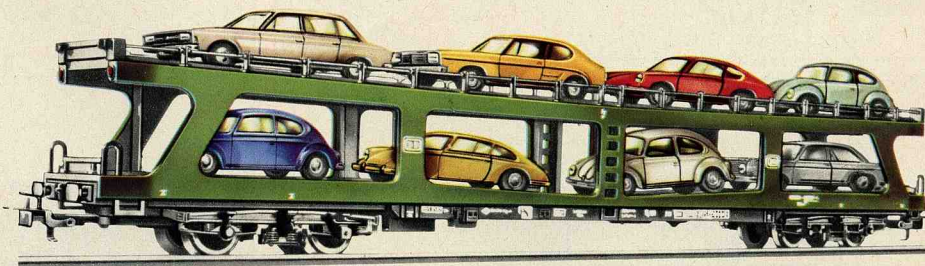

4084

Automobile rack car · A model of the German Federal Railways' type DDm 915 · Without automobiles · Length 26.4 cm

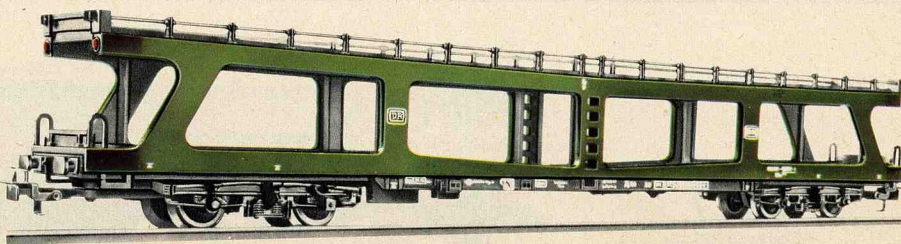

Freight cars with automatic coupling and advance uncouplers (RELEX, see page 38)

These cars all have metal underframes with mat black finish. All wheels are of die-cast zinc. The bodies are made of plastic. All lengths quoted are measured over the buffers.



4500
Tank car · ARAL · Length 10 cm



4501
Tank car · ESSO · Length 10 cm



4502
Tank car · SHELL · Length 10 cm

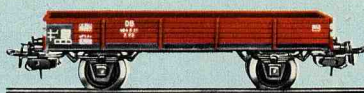

4503
Low-sided car · Length 10 cm

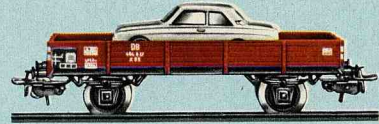

4504
Low-sided car · Loaded with miniature automobile · Length 10 cm

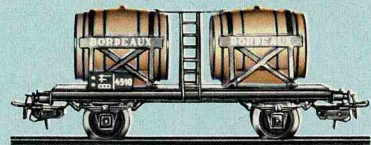

4510
Wine car · Length 10 cm



4511
Pulverized coal car · Length 10 cm

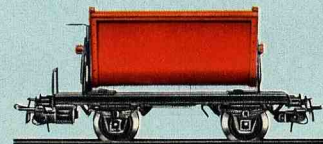

4513
Dump car · Can dump to either side · With locking arrangement · Length 8.5 cm

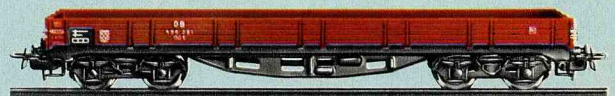

4514
Low-sided car · Length 18 cm

4517
Covered flat car · Length 18 cm



Scale model freight cars with automatic coupling and advance uncouplers (RELEX, see page 38)

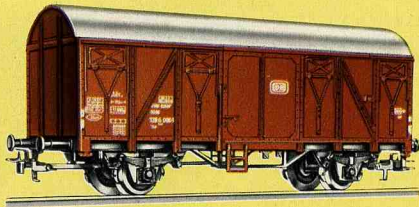

Underframes and bodies are made of plastic, wheels of die-cast zinc.



4410 new

Box car · A model of the German Federal Railways' type Gs · Length 11.4 cm

4411 new

Box car with working taillight · A model of the German Federal Railways' type Grs-v · Current pick-up shoe · Length 11.4 cm
 = 41494  = 60015

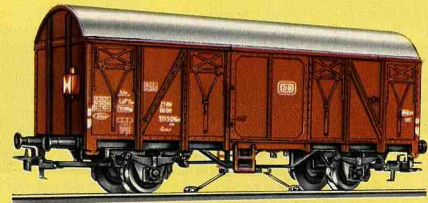

4414 new

Box car for transporting bananas · A model of the German Federal Railways' type lbbls · Length 11.4 cm

4415 new

Refrigerator car · A model of the German Federal Railways' type lchqrs377 · Length 11.4 cm

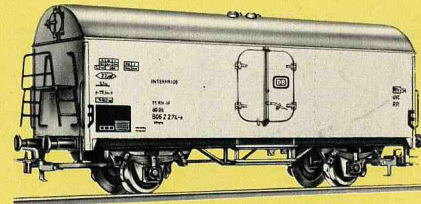

4416 new

Beer car · A model of a car owned by the Dortmunder-Kronen brewery · Length 11.4 cm

4600

Freight train baggage car (German Federal Railways type Dg) · Doors on both sides which will open · Length 9 cm

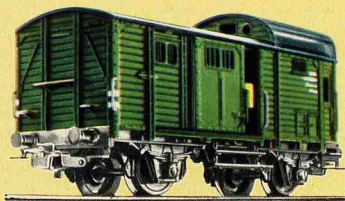

Scale model freight cars with automatic coupling and advance uncouplers (RELEX)

We have paid particular attention to the details of these models. The RELEX coupling is essential for realistic switching. When the coupling has been opened by means of an uncoupling track section, the catch of the coupling stays open so that the car can be pushed away or allowed to roll down a ramp.

4601

Open freight car with brakeman's cab (German Federal Railways type Omm 33) · Length 11.5 cm



4605

Box car with brakeman's cab (Swiss Federal Railways type K³) · Doors on both sides which will open · Length 11 cm

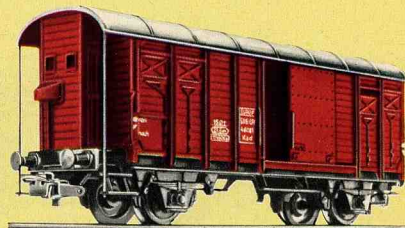

4602

Open freight car (German Federal Railways type Omm 52) · Length 11.5 cm



4607

Low sided car (German Federal Railways type Rmms 33) · With removable stanchions which can be stored in the sliding box under the car floor · Length 13 cm

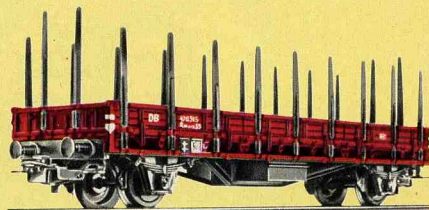

4604

Open freight car (German Federal Railways type Omm 52) · With removable load, simulating coal · Length 11.5 cm



4610

Ballast car with unloading doors operated by a hand lever · Length 9.5 cm



4611

Crane car with slewing crane, with movable boom and boom support · Crane hook can be raised and lowered by hand-cranking · Length of underframe 9 cm · (Low-sided car 4503 is not included in the price, but this item is recommended for use when moving the crane car)

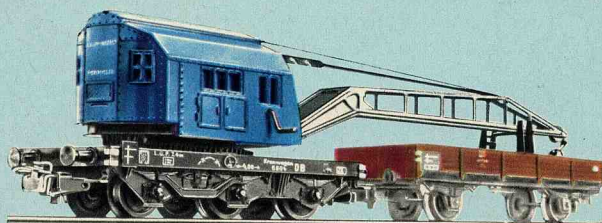

4612

Automobile transporter with loading ramp · Not loaded · Length 11.5 cm · (On the German Federal Railways two transporters are always coupled together to form a unit known as Off 52)

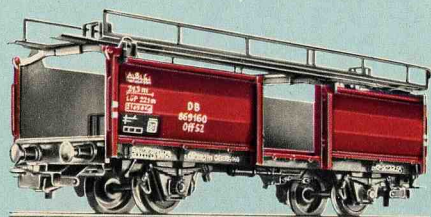

4613

Automobile transporter with loading ramp · Loaded with miniature automobiles · Length 11.5 cm



4617

Well car · Loaded with transformer · Length 25 cm

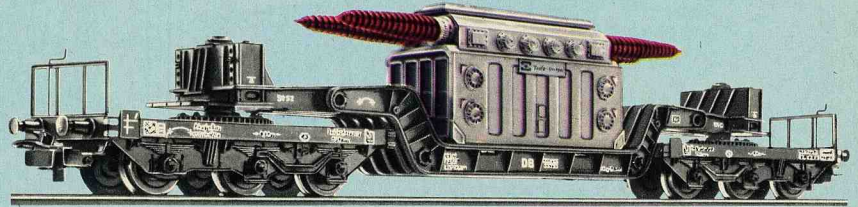

4618

Well car · Loaded with crate · Length 25 cm

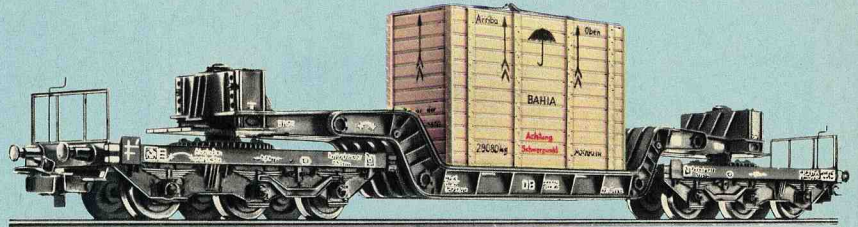

4619

Sliding-roof car (German Federal Railways' type Kmmks 51) · The two halves of the roof will slide open · Length 11.5 cm



4631

Side dumping car · A model of the German Federal Railways' type Otmm 70 · Length 11.2 cm

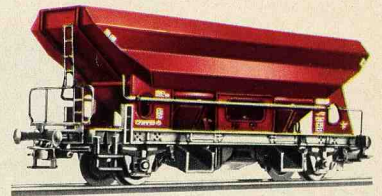

The discharge doors can be operated by handlevers, or by remote control using the uncoupling track sections 5112 (page 50) or 2197 (page 52).

4624

High-capacity freight car (semitrailer) · A model of the German Federal Railways' type OOtz 50 · Length 13.3 cm



This type of car is used in international traffic for transporting coal, coke, ore etc, generally in permanently made-up high capacity trains.

4632

Beer car · Length 19.5 cm



4626

High-capacity freight car with hinged hatches on roof · A model of the German Federal Railways' type Kkt 57 · All hatches will open · Length 13.3 cm



On a number of high-capacity freight cars, fixed covers are fitted so that bulk materials such as grain, which need protection from the elements, can be carried.

4633

Freight car with sliding sides and roof (German Federal Railways' type Kimmgs 66) · The roof halves and the sides will slide open · Length 15.7 cm

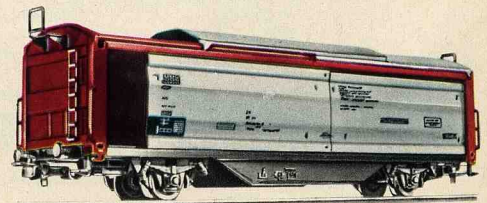

4627

Box car · A model of the German Federal Railways' type Gimmehs 57 · Length 13.3 cm

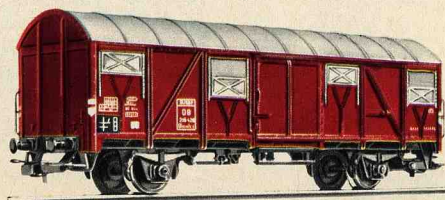

4635

Tipping bucket car · A model of the German Federal Railways' type Ommi 51 · The buckets can be tipped when the center holding bar is unfastened · Length 10.5 cm





4639

Open freight car · A model of the Netherlands State Railways' (NS) car · Length 11.5 cm

Scale model freight cars with automatic coupling and advance uncouplers (RELEX, see page 38)

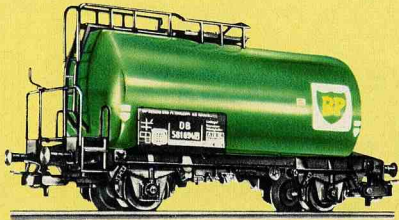

4644

Tank car · A model of the standard tank car with BP markings · Length 10 cm



4661 **new**

Tank car for fine bulk material · A model of the German Federal Railways' type Ucs (Kds 54) with the marking "Quarz-Werke" · Length 10 cm



4646

Tank car · A model of the standard tank car with ARAL markings · Length 10 cm

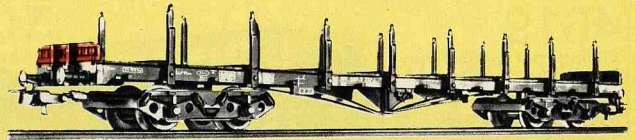

4663

Flat car · A model of the German Federal Railways' type SSImas 53 · Car floor made of die cast zinc · Uprights can fold down · Length 22.7 cm



4647

Tank car · A model of the standard tank car with BAYER markings · Length 10 cm

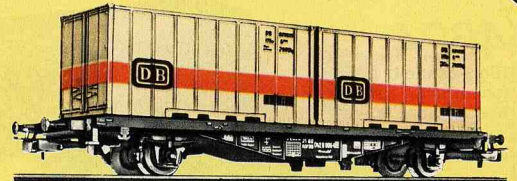

4664

Container car · A model of the German Federal Railways' "Berlin" type container cars · Loaded with two removable containers · Length 15.6 cm

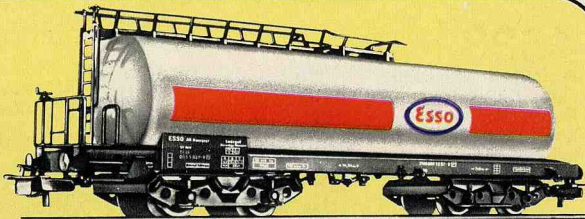

4650

Tank car · ESSO · Length 16.4 cm

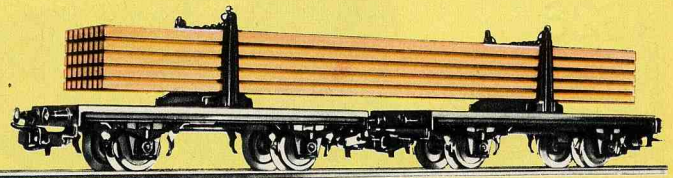

4665

Lumber car in two parts · Loaded with sawn lumber · Length 19.5 cm



new
4651

Tank car · SHELL · Length 16.4 cm



4667

Beer car · A model of a car owned by the Bavaria St. Pauli Brewery · Imitation ventilators on roof · Length 13.3 cm

Scale model freight cars 4600 American freight cars Car construction kits

4668

Container car · A model of the German Federal Railways' "Berlin" type container car · Loaded with two removable containers · Length 15.6 cm

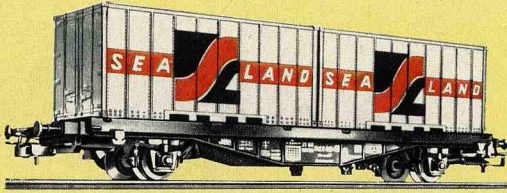

4669

Beer car · A model of a car owned by the Kulmbacher Reichelbräu brewery · Imitation ventilators on roof · Length 13.3 cm



7291

Pack of 4 containers with different markings · Will fit on underframes of cars 4664 and 4668

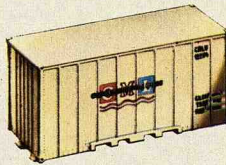

American freight cars



4571

Box car · A model of the 50 ton car of Western Pacific Railroad · Walkway mounted on roof · Doors on both sides which will open · Length 20.5 cm

4575

Gondola · A Dixie Line model · Length 20 cm

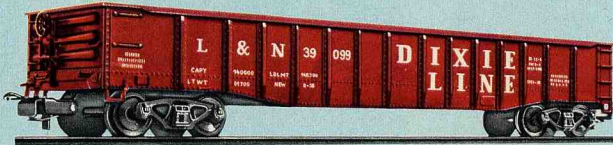

4578 **new**

Caboose · Roof structure with walkway and ladders · Length 8 cm



Car construction kits

These kits enable you to build your own cars. Each kit includes the necessary illustrated instructions, and all kits include automatic couplings with advance uncouplers (RELEX). To assemble them, the only tools you need are a screwdriver and a pair of pliers, with a hammer as well for car 4902.

Models 4918 and 4937 are available only in kit form.



4902 **Open freight car kit**
Assembled kit 4902



4918 **Refrigerator car kit**
Assembled kit 4918

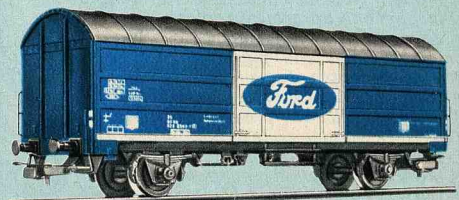

4937 **Box car kit**
Assembled kit 4937

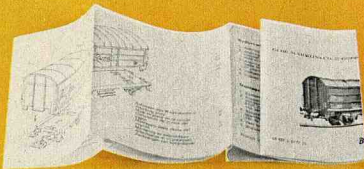

Remote controlled turntable

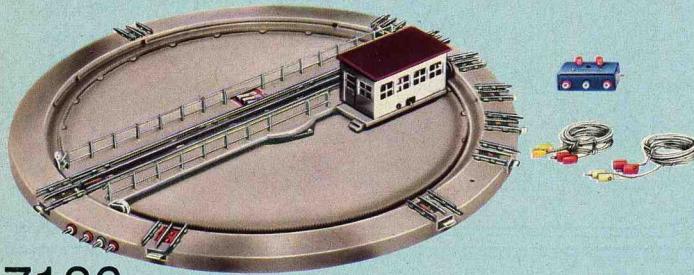

7186

Turntable set · Consisting of turntable with 360 mm outside diameter turning in either direction by remote control, with reversing switch and lead · Current is automatically cut off from all storage tracks not in contact with the turntable track

Adapter track section 2191 (see page 52) enables K-tracks of the 2100 series to be connected to the turntable 7186.

Locomotive roundhouse

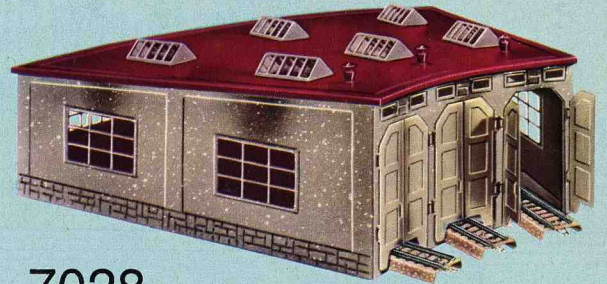

7028

Locomotive roundhouse with 3 automatically closing doors for 3 tracks · (Track sections not included) · Size 460 x 370 mm · Height 135 mm

A turntable and roundhouse make a steam locomotive layout even more realistic. The turntable is used to turn locomotives round on the spot and get the smoke stack in front. Most steam locomotives are permitted to travel forwards faster than in reverse. The turntable is also used to feed locomotives into the 3 or 6 track roundhouse or to put them back on the right departure track. Current is disconnected from all storage tracks not in contact with the turntable track.

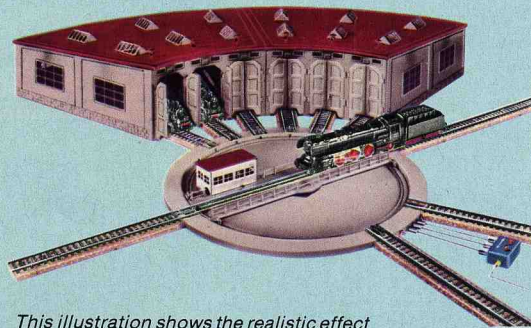

This illustration shows the realistic effect obtained by combining 2 roundhouse sections and a turntable.

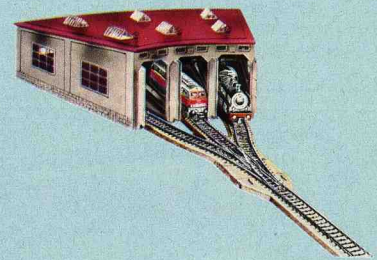

Suggested combination of roundhouse 7028 with threeway turnout 5214.

Remote controlled rotating crane

7051

Remote controlled rotating crane with lifting magnet · One motor rotates the boom, another raises and lowers the load · Load hook and lifting magnet enable iron or iron-containing objects to be transferred by remote control · Boom adjustable manually for elevation · Working light in control cab · Height 260 mm · Base 90 x 90 mm · 1 combined control and switch panel · Price does not include locomotive, cars or track
 Ⓛ = 60000

If you want to load and unload your trains properly, you need this crane. The lifting magnet only attracts iron objects of course. You are not confined to loading "scrap-metal" and "pig-iron" however. Screw a couple of small screws inconspicuously into wooden freight, and everyone will be surprised to see the magnet lift a wooden crate or box out of a truck onto a freight car. A rotating crane not only introduces new, interesting variations into the operation of a model railroad, since all the operations can be remotely controlled, but it also adds realism to the transport procedure.

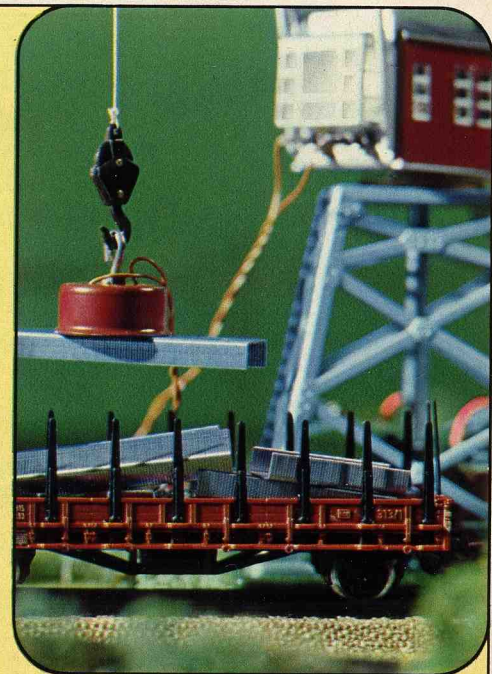
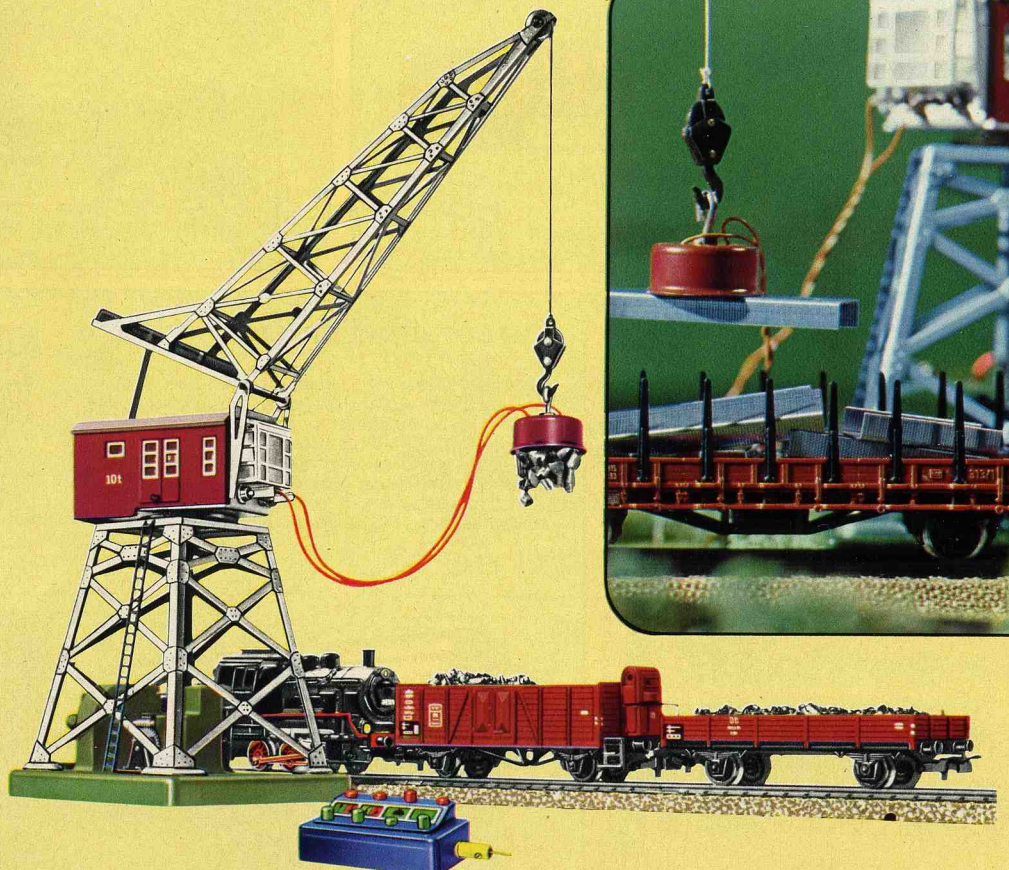

Grade-crossings for M-tracks

7292 M

Grade-crossing with half-barriers for metal tracks · The set consists of two solenoid-operated barriers, each with two red warning lights which come on when the barriers are closed, and a set of contact track sections (1½ straight track sections long) · Size of base: 137 × 95 mm
 Ⓚ = 60201

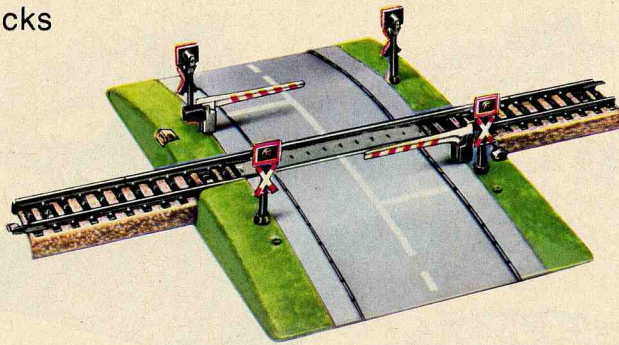

Guarded grade-crossings with automatic barriers. As soon as an approaching train runs on to the contact track sections the barriers close. They open again when the last car has cleared the contact track section beyond the crossing.

7293 M

Extension set for grade-crossing 7292 · One required for each additional parallel track · Consists of a set of contact track sections (1½ straight track sections long) and a separating piece, adjustable between 43 and 78 mm, which is placed between the two tracks

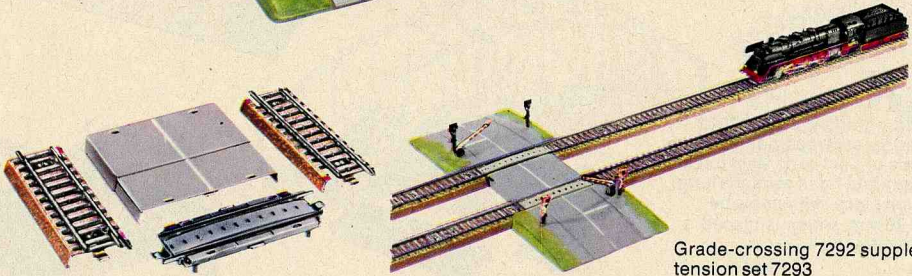

Grade-crossing 7292 supplemented by extension set 7293

7192 M

Fully automatic grade-crossing with M-track sections · The set consists of two solenoid-operated barriers with an attendant's box (capable of being fitted with interior lighting), warning crosses and a set of contact track sections (2 straight track sections long)

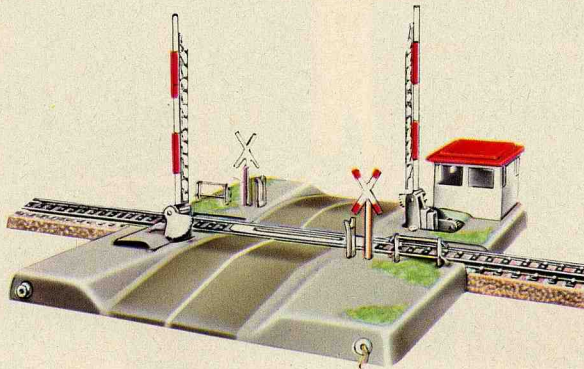

The grade-crossing 7192 can also be adapted for use with more than one track by the addition of the extension set 7193. In this case, it still operates automatically.

Contact track sections



5115 straight · Length 180 mm



5116 curved · Radius 360 mm

*These M-track sections 5115 and 5116 are for extending the contact sections of grade-crossings 7192 and 7292. The contact sections can be extended **only** with track sections 5115 and 5116.*

7193 M

Extension set for the fully automatic grade-crossing 7192 · One required for each additional parallel track · Consists of a set of contact track sections and a separating piece which is placed between the tracks

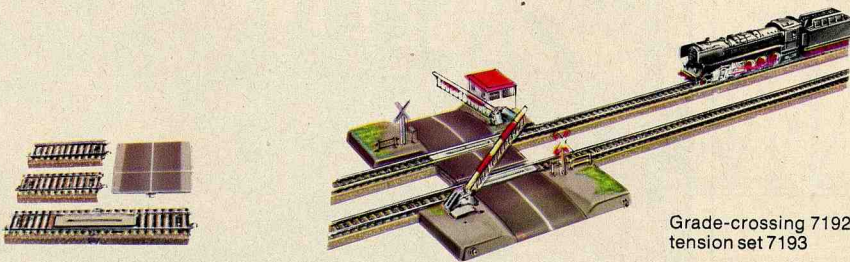

Grade-crossing 7192 supplemented by extension set 7193

7390 M

Mechanically operated grade-crossing for a single-track line using M-track sections · The barriers are operated by the wheels of a passing train pressing down a lever arm · The length of the grade-crossing track section is the same as that of track section 5106 · Base 120 × 180 mm

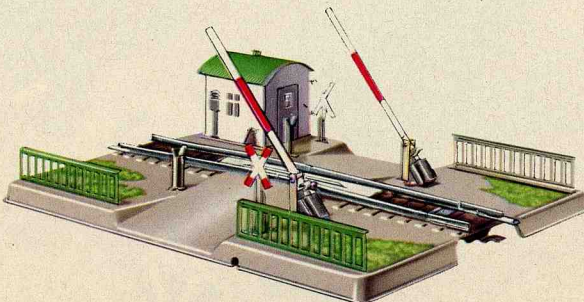

Adapter track section 2191 (see page 52) enables K-tracks of the 2100 series to be connected to grade-crossings 7192 and 7390.

Grade-crossing for K-tracks

7592 K

Grade-crossing with half-barrier for K-tracks · The set consists of 2 solenoid-operated barriers, each with 2 red warning lights which come on when the barriers close, and a set of contact track sections (1½ straight track sections long) · Size of base: 137 × 95 mm

⊙ = 60201

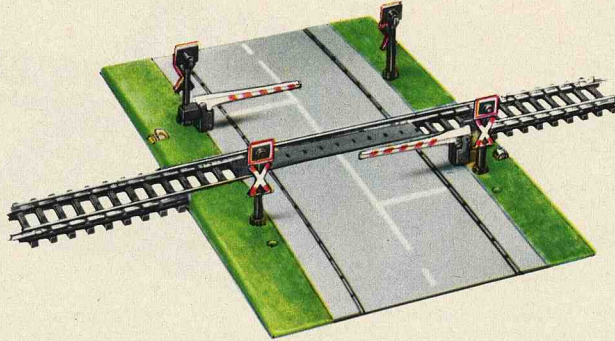

7593 K

Extension set for grade-crossing 7592 · One is required for each additional parallel track · Consists of a set of contact track sections (1½ straight track sections long) and a separation piece, adjustable between 43 and 78 mm, which is placed between the two tracks

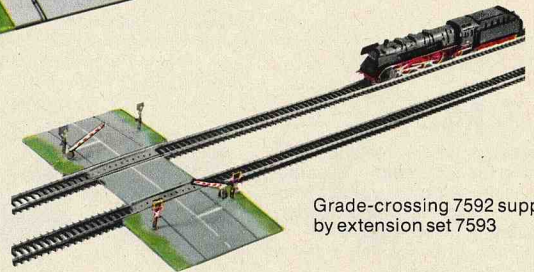
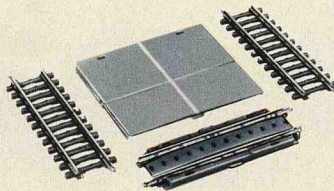

Grade-crossing 7592 supplemented by extension set 7593

Warning bells for tracks of all gauges



7221

Warning bell, two-tone · Solenoid operated · Operating voltage 16 V · Operated from control panel · Height 42 mm · Diameter 50 mm



7222

Warning bell, two-tone · Operated by hand crank · Height 100 mm · Base diameter 40 mm



Märklin bridges in plastic for K + M-tracks

With the Märklin bridge parts any size of combination of bridges or ramps can be built. The pier construction elements 7252 and 7253, which fit together like building blocks, enable piers of any height to be built up in steps of 6 mm. By using the base plate 7251 in conjunction with the base plate 7250 it is even possible to raise the height in steps of 3 mm. For fixing the pier sections to each other and to the plate the use of flat-head wood screws 7599 is recommended.



7267 K + M

Curved ramp section · Gray · Radius of curvature 360 mm · For use with plastic or metal tracks · 3 clips for fastening the K-track · Length and radius as for track sections 2121 and 5100

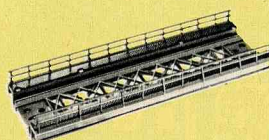

7268 K + M

Straight ramp section · Gray · For use with plastic or metal tracks · 3 clips for fastening the K-tracks · Length 180 mm

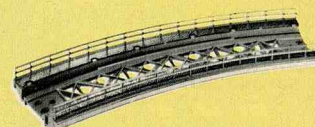

7269 for M only
Curved ramp section · Gray · Radius of curvature 437.4 mm · For use with metal track 5200 only · Track curves through 30°

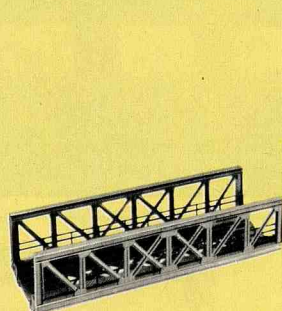

7262 K + M

Truss bridge · Gray · Can be used on its own or with arched bridge 7263 · For use with plastic or metal tracks · 3 clips for fastening the K-tracks and instructions for building the bridge · Height 45 mm · Length 180 mm

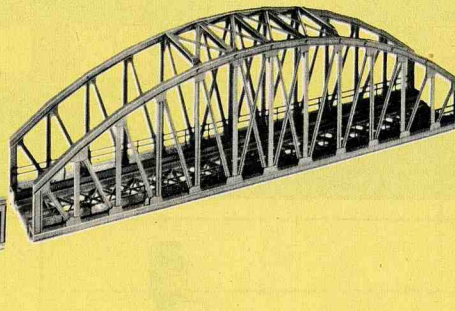

7263 K + M

Arched bridge · Gray · For use with plastic or metal tracks · 6 clips for fastening the K-tracks and instructions for building the bridge · Maximum height 117 mm · Length 360 mm



7569 for K only
Curved ramp section · Gray · Radius of curvature 424.6 mm · For use with plastic tracks only (Standard Circle II, see page 52) · 3 clips for fastening the track section · Length and radius as for track section 2131

7234

Base plate · For fixing signal masts of the 7200 series to bridges



Complete instructions for the assembly of bridges are included with bridges 7262 and 7263.

7250

Base plate · 2.5 mm thick · Light brown · Can be used as foundation



7251

Base plate · 3 mm thick · Light brown · Can only be used in conjunction with 7250



7252

Pier · 6 mm high · Gray · Suitable for building ramps with 6 mm rise from one pier to the next



7253

Pier · 30 mm high · Gray



Examples of bridge and ramp construction

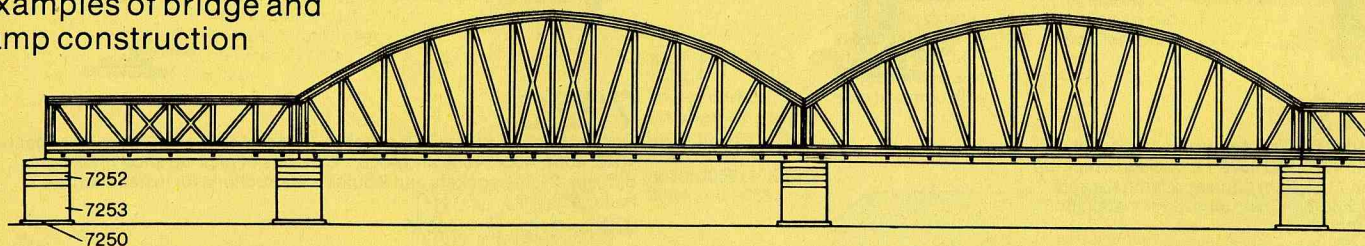

0	2,5 = 1 x 7250	5,5 = 1 x 7250 1 x 7251	11,5 = 1 x 7252 1 x 7250 1 x 7251	17,5 = 2 x 7252 1 x 7250 1 x 7251	23,5 = 3 x 7252 1 x 7250 1 x 7251
6 mm Steigung	Pfeilerhöhe bei M-Gleisen				
0	2,5 = 1 x 7250	2,5 = 1 x 7250	8,5 = 1 x 7252 1 x 7250	14,5 = 2 x 7252 1 x 7250	20,5 = 3 x 7252 1 x 7250
6 mm Steigung	Pfeilerhöhe bei K-Gleisen				
0	2,5 = 1 x 7250	5,5 = 1 x 7250 1 x 7251	11,5 = 1 x 7252 1 x 7250 1 x 7251	20,5 = 3 x 7252 1 x 7250	29,5 = 4 x 7252 1 x 7250 1 x 7251
9 mm Steigung	Pfeilerhöhe bei M-Gleisen				
0	2,5 = 1 x 7250	2,5 = 1 x 7250	8,5 = 1 x 7252 1 x 7250	17,5 = 2 x 7252 1 x 7250 1 x 7251	26,5 = 4 x 7252 1 x 7250
9 mm Steigung	Pfeilerhöhe bei K-Gleisen				

Electric lighting for trains

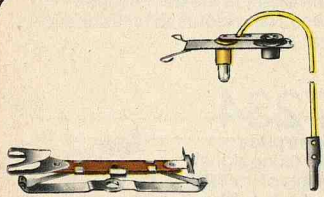
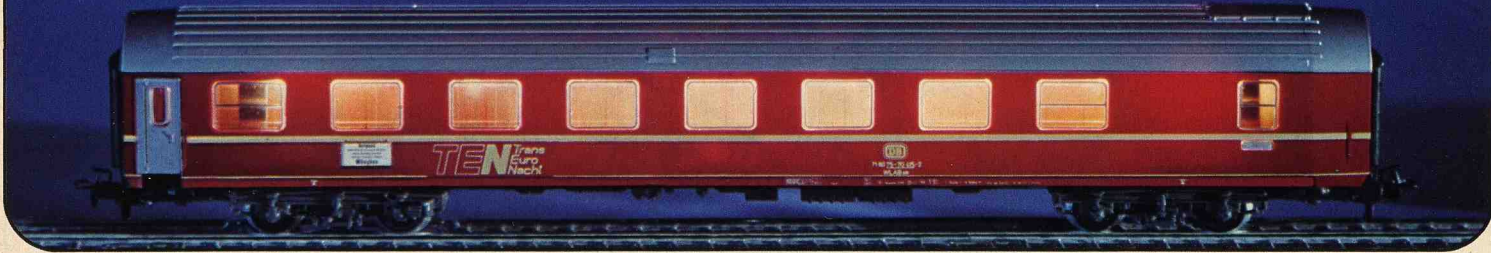
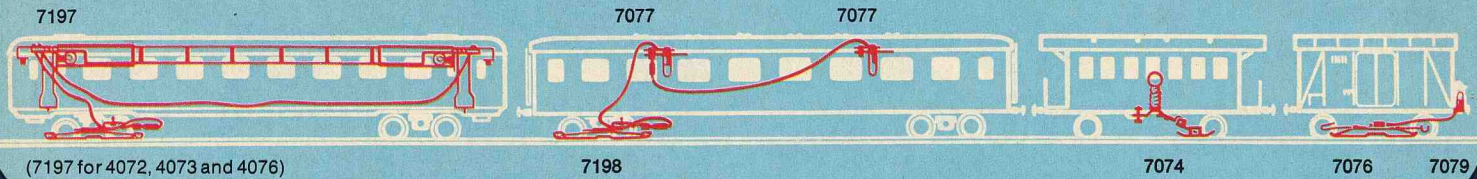

7076

Pick-up shoe for taillight 7079 when used on passenger cars 4000 and 4040 and on two-axle freight cars

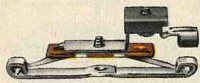

7077

Interior lighting set for most express coaches · With socket for connecting additional lighting set · Light bulb = 60000



7198

Pick-up shoe for interior lighting set 7077
= 7175

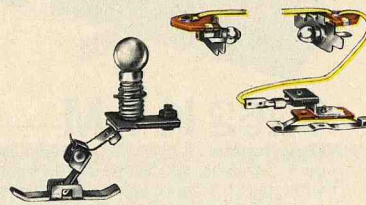

7079

Taillight including bulb · Clips onto buffer · For use on cars with metal buffers only · For connecting it up, 7074, 7076, 7077 or 7198 is required
= 60001 (red)

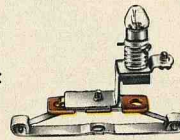

7074

Interior lighting set for passenger cars 4004, 4005, 4079 and 4080 · With socket for connecting additional lighting sets · Light bulb = 60020

7322

Interior lighting set for the TEE coach 4090 · Consists of pick-up shoe 7198, 2 lamp sockets and 2 bulbs · Instructions for installation are included
= 7175 = 60015

7323

Interior lighting set for coaches 4007 and 4008 · Light bulb = 60010

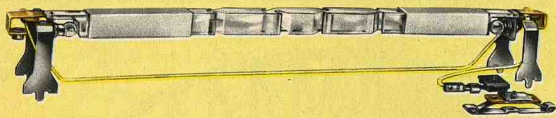

7197

Interior lighting set for express coaches 4072, 4073 and 4076 · Consists of pick-up shoe 7198, light diffuser, 2 lamp sockets and 2 bulbs · Instructions for installation are included

= 7175 = 60015

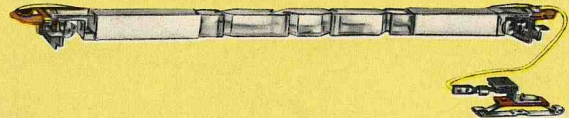

7320

Interior lighting set for TEE coaches 4085 and 4087 and for express coaches 4049, 4054, 4064, 4066 and 4069 · Consists of pick-up shoe 7198, light diffuser, 2 lamp sockets and 2 bulbs · Instructions for installation are included

= 7175 = 60015

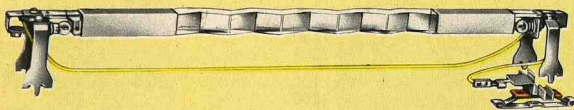

7324

Interior lighting set for express coaches 4091, 4092, 4093 and 4094 **not marked "A"** on bottom of car · Consists of pick-up shoe, light diffuser, 2 lamp sockets and 2 bulbs · Instructions for installation are included

= 7175 = 60015

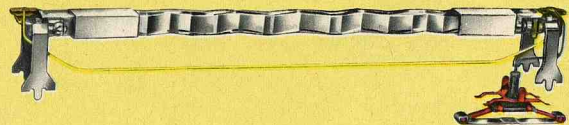

7325

Interior lighting set for express coaches 4091, 4092, 4093 and 4094 **marked "A"** on bottom of car, for TEE coaches 4095, 4096, 4097 and 4099 and for express sleeping car 4150 · Consists of pick-up shoe, light diffuser, 2 lamp sockets and 2 bulbs · Instructions for installation are included

= 41494 = 60015

Light bulbs

for the following items:

60000

2161, 3015, 4044, 4077, 4081, 5117, 5128, 5137, 5140, 5202, 7036, 7037, 7038, 7039, 7040, 7041, 7042, 7051, 7077, 7191, 7280, 7281, 7282, 7283, 7284

60001

3071, 3076, 7079, 7188, 7339, 7539 (red)

60002

7188, 7339, 7539 (green)

60010

3000, 3003, 3016, 3021, 3031, 3064, 3065, 3072, 3095, 4018, 4506, 5113, 7046, 7047, 7048, 7323

60015

3022, 3030, 3034, 3035, 3037, 3038, 3039, 3040, 3041, 3043, 3044, 3050, 3054, 3055, 3056, 3058, 3060, 3062, 3066, 3067, 3068, 3071, 3074, 3075, 3076, 3077, 3078, 3084, 3085, 3086, 3089, 3092, 3093, 3094, 3096, 3098, 4053, 4060, 4062, 4089, 6631, 7197, 7320, 7322, 7324, 7325

60020

7073, 7074

60200

7242

60201

7239, 7240, 7241, 7292, 7592 (red)

60202

7187, 7236, 7237, 7238, 7239, 7240, 7241 (green)

60204

7187, 7236, 7237, 7238, 7240, 7241 (orange)

Non-skid tires

for the following locomotives:

7152

3085, 3086, 3089, 3092, 3093, 3094, 3098

7153

3003, 3015, 3016, 3022, 3030, 3034, 3035, 3037, 3038, 3039, 3040, 3041, 3043, 3050, 3054, 3056, 3058, 3064, 3065, 3084, 3095, 3096

7154

3000, 3021, 3031, 3044, 3055, 3060, 3062, 3066, 3067, 3068, 3071, 3072, 3074, 3075, 3076, 3077, 3078, 3080, 3087, 3090

Current pick-up shoes

for the following locomotives, cars and lighting sets:

7164

3016, 3022, 3034, 3035, 3037, 3038, 3039, 3040, 3041, 3043, 3050, 3054, 3055, 3056, 3058, 3066, 3067, 3068, 3071 front, 3072, 3074, 3075, 3076, 3077, 3084, 3085, 3096

7175

3015, 3071 rear, 4018, 4044, 4053, 4077, 4081, 4089, 7197, 7198, 7320, 7322, 7323, 7324

7183

3021

7185

3000, 3003, 3030, 3031, 3044, 3060, 3062, 3064, 3065, 3078, 3080, 3086, 3087, 3089, 3090, 3092, 3093, 3094, 3095, 3098, 4060, 4062

Reverser unit springs

7194

Pack with 5 springs for reversing switch

Instructions for fitting non-skid tires, current pick-up shoes, light bulbs and reverser unit springs are given in the "Instructions for use".

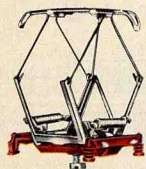

7218
Pantograph current collector · 1 cheese-head screw

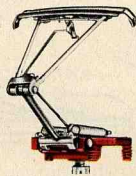

7219
Single arm current collector · 1 cheese-head screw · The catenary system must be very carefully set up when 7219 is used



60030
Pair of carbon brushes for most HO gauge locomotives

60035
Pair of carbon brushes for locomotive 3015

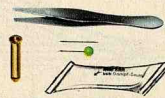

7226
Smoke set · Consisting of smoke unit (to fit locomotives 3084 and 3085), substitute steam pipe, cleaning wire, pair of tweezers and a capsule of smoke fluid



7227
Smoke set · Consisting of smoke unit (to fit locomotives 3092 and 3093) and a capsule of smoke fluid



0241
Smoke fluid in plastic capsule as refill for smoke sets 7226 and 7227

60146

Pair of carbon brushes for locomotives 3034, 3035, 3037, 3038, 3039, 3056, 3058, 3084 and 3085



7199
Bottle of oil · Contains about 10 cu. cm. lubricating oil for locomotives and cars



7001
Coupling gauge made of nickel plated steel sheet, for checking locomotive and car couplings

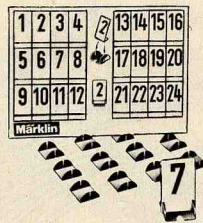

7195
Number plate set · For identifying turnouts and signals in the track layout · Contents: 12 slotted bases, number plates 1-24 which can fit in the slots

7224

Re-railing device · Made of plastic · Makes it easier to set multi-axle vehicles on the track · Length 300 mm · Height 25 mm

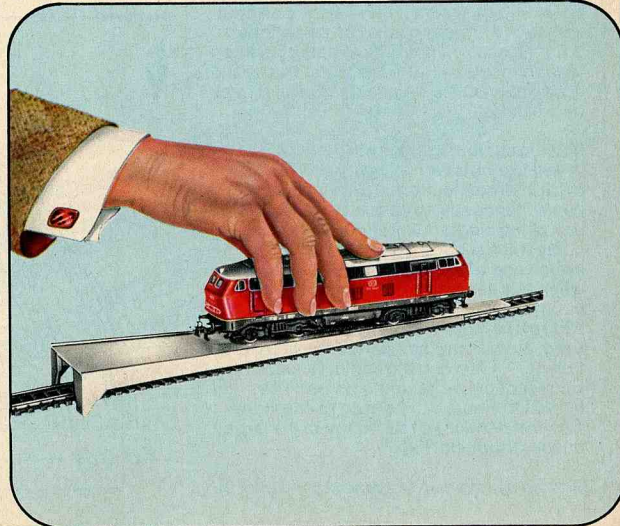

How the different Märklin M-track circles compare

This diagram shows the three Märklin M-track circles, with their radii, distances apart from each other, and curvatures, and also the number of track sections comprising a semicircle (Fig. 1).

- 1 circle 5200 = 12 track sections
- 1 circle 5100 = 12 track sections
- 1 circle 5120 = 8 track sections

Concentric circles

Concentric circles can be constructed by using track sections of the 5100 and 5200 series. This gives a distance between track centers of 77.4 mm (measured from contact stud to contact stud) and a clearance between tracks of 39 mm. The turnouts 5202, 5221 or 5140 are used to cross from the inner to the outer loop (Fig. 2).

M-turnouts and their use

The electromagnetic turnouts 5137, 5140 and 5202 and the double slip switches 5128 and 5207 are operated by double solenoids. If a vehicle approaches the turnout from the wrong direction, its wheels open up the closure rail, so that derailment does not take place. The turnouts return automatically to their initial setting. Further turnouts can be joined directly on to either end of a turnout section.

Branches using 5100 series turnouts

When track section 5100 is fitted as a reverse curve onto the branch track of turnout 5137, the resulting distance between track centers is 96.4 mm. With the through track extended by track section 5106, the two branches have exactly the same length. Length of this assembly is $2 \times 180 \text{ mm} = 360 \text{ mm}$, i.e. the same as 2 track sections 5106 (Fig. 3).

Branching of a parallel track section using turnouts 5137 (Fig. 4).

When the track sections supplied are used as reverse curves the distance between track centers is reduced from 96.4 mm to 54.8 mm (Fig. 5).

If the tracks of a 3- or more track layout are to be interconnected, retaining the 96.4 mm distance between track centers, it is necessary to use crossing 5114 or double slip switch 5128. The double slip switch has the advantage that a train diverted by a turnout on one of the outer tracks can be switched onto the center track. The simple crossing interconnects only the two outer tracks and does not enable a transfer to the inner track (Fig. 6).

Märklin curved turnouts 5140
These turnouts were developed to enable track interconnections to be made on the curve, hence saving space. Close examination of the diagram will show that a standard circle track section (5100) is fitted to the switch end of each curved turnout, even when this lies on the larger concentric circle. In other words, the longer track section 5200 of the large concentric circle is not used, as with this the track center separation of 77.4 mm and the coincidence of the track section joints would be lost. The curved turnouts can be used to interconnect the standard circle only with the large concentric circle (Fig. 7).

Branch using a curved turnout 5140 (Fig. 8).

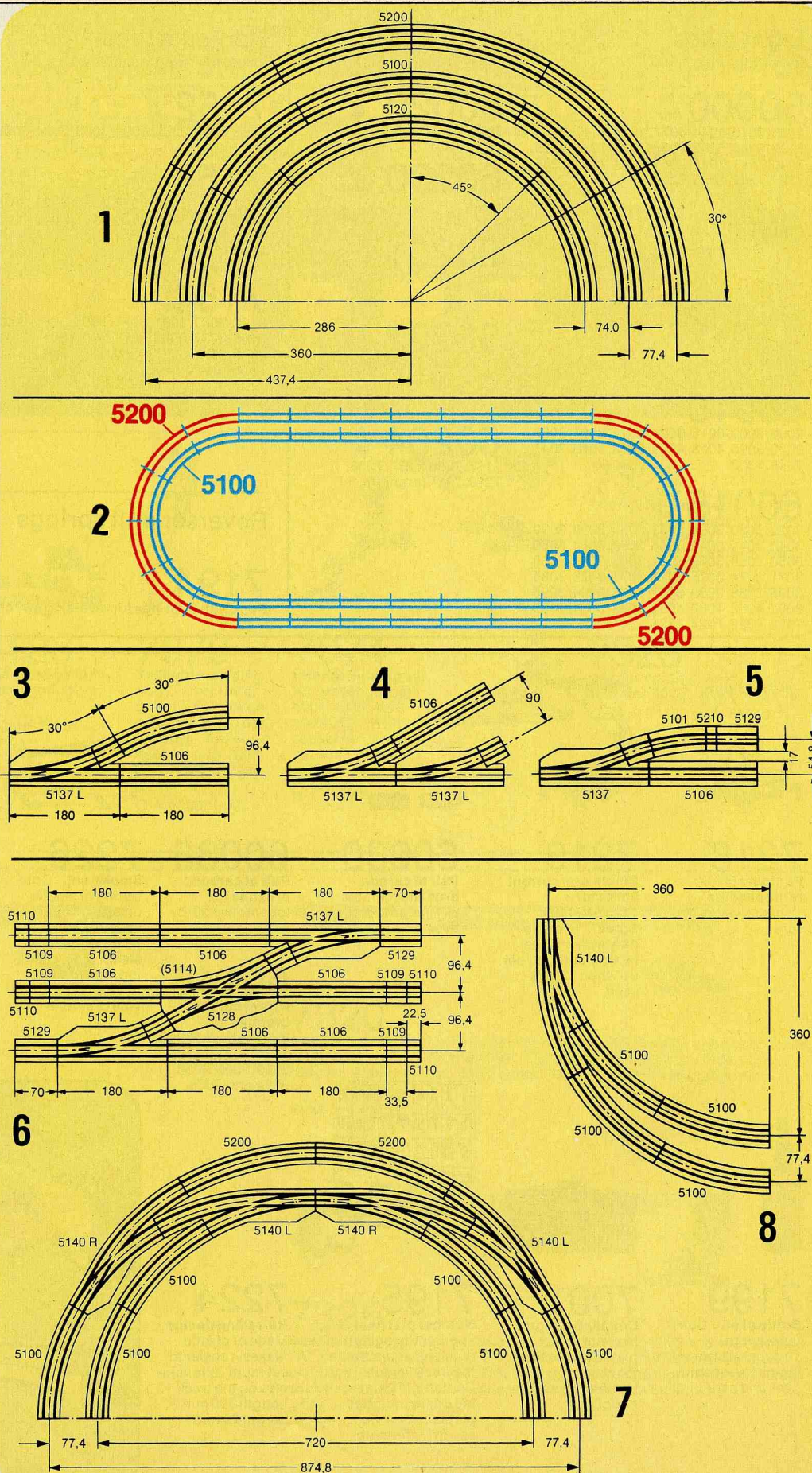

Features of the M-track (M = metal track body)

Here we show our proven metal track. The special feature of this track is the covered current feeder in the roadbed, with its stud contacts which project upwards in the center of the track through the cross-ties. The long pick-up shoes between the locomotive wheels slide over these contacts. Each track section consists of the

roadbed, which looks very realistic with its rock ballast and strong cross-ties, and the two rails, which are electrically connected to the roadbed. Each rail has one jointing clip, at opposite ends of the track section.

The current feeder has spring contact tongues at each end. These lock together when the track sections are joined. At the same time the jointing clips slide onto the rails. The result is the solid electrical connection typical of the Märklin system, combined with good mechanical rigidity of the assembled layout.

The screws needed for mounting the track using sound-absorbent strips 7171 (see page 51) are included in the pack. For track mounting without sound absorbent strips we recommend the use of screws 7299 (see page 51).

Branches using turnouts 5200

Track section 5206 is used as the reverse curve for turnouts 5202. The distance between track centers is 77.4 mm, the same as the distance between the standard and the large concentric circles. If the through track is extended by track section 5106, it terminates in line with the end of track section 5206 (Fig. 9).

Branching of a parallel track section using turnouts 5202 (Fig. 10).

Parallel track sections with turnouts 5202 (Fig. 11).

If the tracks of a 3-or-more track layout are to be interconnected, retaining the 77.4 mm distance between the centers of the normal circle and large concentric circle tracks, the double slip switch 5207 is required. An advantage of this double slip switch is that the straight sections are exactly the same length as straight track sections 5106. But note that the diagonally running track of the double slip switch 5207 must be made up using the track sections 5208, 8 mm in length (Fig. 12).

Interconnection of parallel tracks (Fig. 13).

Märklin three-way turnout 5214

In the Märklin three-way turnout 5214, two simple turnouts 5202 are combined, the unit being the same length as a turnout 5202 and hence the same length as a straight track section 5106 (full length = 180 mm). The three-way turnout can thus save a lot of space, which can be particularly helpful in station tracks and in groups of crossings (Fig. 14).

This figure shows how the Märklin three-way turnout enables a main track and 4 branch tracks to be formed in the least possible space (Fig. 15).

Track branching using three-way turnouts (Fig. 16).

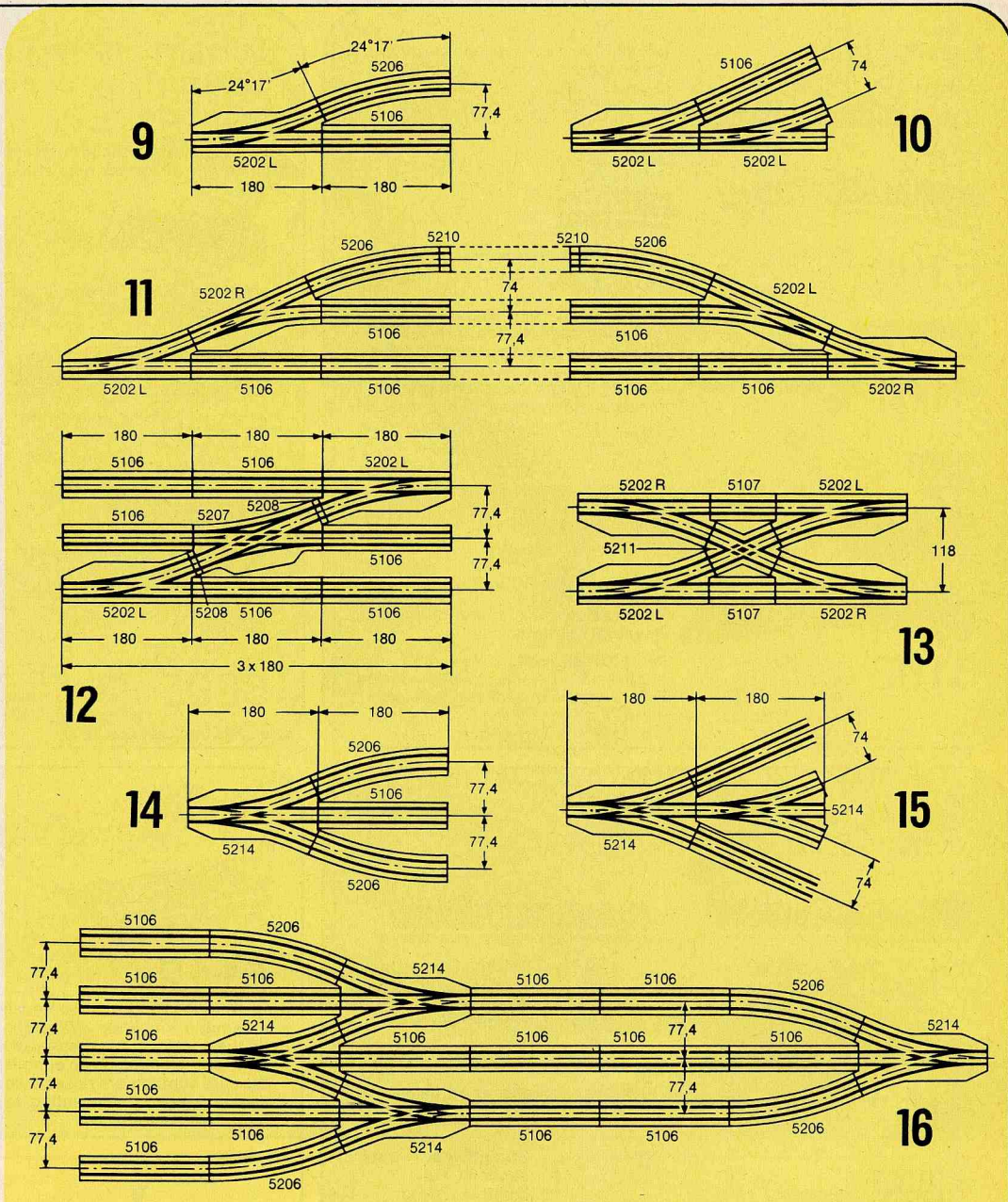

Summary of examples of use of Märklin M-turnouts (Fig. 17)

You will find further examples of possible combinations and methods of use in publication 0392, "HO gauge layouts for M-tracks 5100/5200" (see page 62).

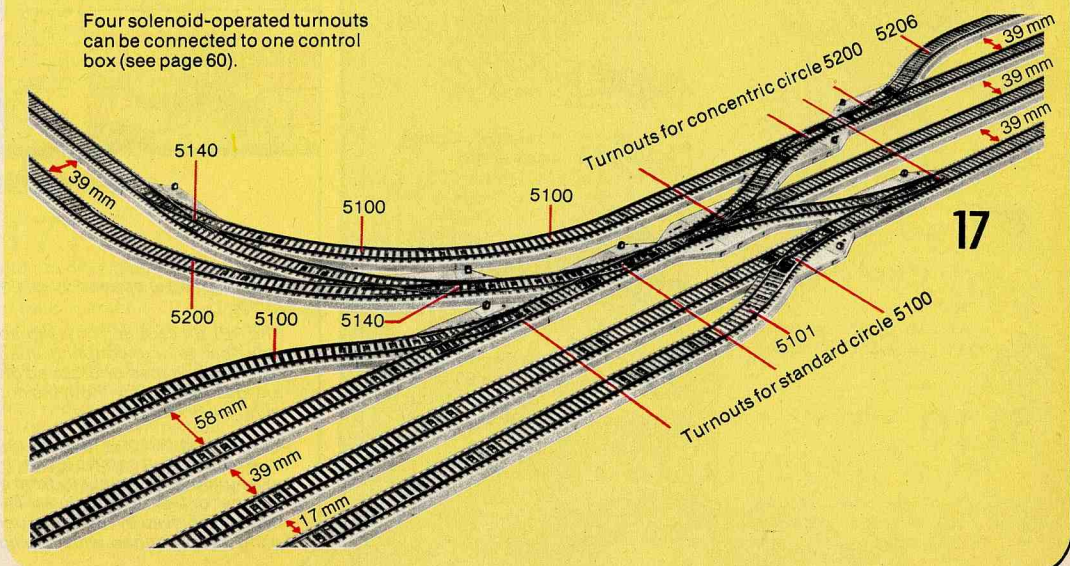

M(=metal)-tracks for trouble-free assembly

Curved track sections 5100 for standard circle

Twelve 5100 track sections make up a circle with an outside diameter of 76 cm.



5100 Full length = 30°



5101 Half length = 15°



5102 Quarter length = 7° 30'



5103 Curved feeder track section · Full length = 30° · 2 connecting leads



5147 Curved switching track section · Half length = 15°

Switching track sections

Switching track sections (5146, 5147, 5213) can be used to control one operation in either direction of travel—i.e. two altogether. Each operation may apply to one solenoid-operated item or to several simultaneously. The switching track sections are triggered by the current pick-up shoes on locomotives or cars.



5120 Small radius track for branch lines and industrial railroads

Curved track section · Full length = 45° · 8 track sections make up a circle with an outside diameter of 61 cm

Curved track sections 5200 for large concentric circle

Twelve 5200 track sections make up a circle with an outside diameter of 91.2 cm.



5200 Full length = 30°



5206 Length = 24° 17' · Matches the curve of the turnouts 5202 and 5221



5201 Half length = 15°



5205 Length = 5° 43' · This section, used with section 5206, equals track section 5200



5213 Curved switching track section · For concentric circle · Half length = 15° · Assembly and use as for 5146 and 5147



5208 Straight make-up section · Length 8 mm



5210 Straight make-up section · Length 16 mm



5211 Crossing · Crossing angle 48½° · Length 98 mm · The center conductors of the crossing are electrically isolated from each other

Straight track sections 5100



5106 Full length = 180 mm



5107 Half length = 90 mm



5129 Make-up section · Length 70 mm



5108 Quarter length = 45 mm



5109 3/16 length = 33.5 mm



5110 1/8 length = 22.5 mm



5111 Straight feeder track section · Full length = 180 mm · 2 connecting leads



5131 Straight feeder track section · Full length = 180 mm · Built-in radio interference suppressor · 2 connecting leads · One 5131 should be used for each traction current circuit



5146 Straight switching track section · Half length = 90 mm

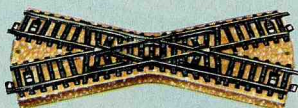

5114 Crossing · Length 193 mm = 30° · The center conductors of the crossing are electrically isolated from each other

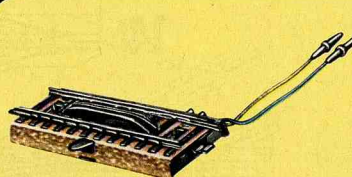

5112 Uncoupling track section for releasing automatic couplings · When the button on the control box is pressed, the solenoid-operated ramps on either side of the stud contacts are raised, releasing the couplings · 2 connecting leads · Length of track 90 mm



5113 Light standard to go with the uncoupling track section · Die cast zinc · The light shows while uncoupling is in process · Height 85 mm · ⚡ = 60010

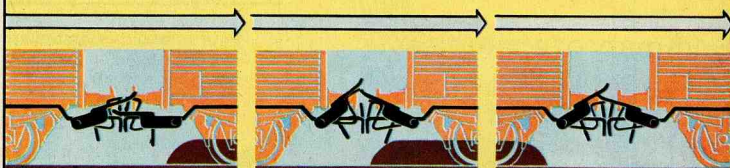

The coupling is opened by raising the ramp.

The RELEX coupling is designed to stay open after uncoupling, enabling cars to be pushed or dropped off at any desired point without the coupling closing again.

Railroading can only become really true to life when cars no longer have to be uncoupled manually from one another or from locomotives. This can be achieved by the use of uncoupling track sections, with their light

standards which indicate when the uncoupler is being operated. That not only looks right, it makes uncoupling easy too. When the coupling concerned, whether locomotive/car or car/car, is next to the signal standard, press the appropriate button on the control box once and the coupling will open, leaving the disconnected car or section of the train standing still. Cars with the advance uncoupler (RELEX) can then be pushed back again by the locomotive under remote control without the coupling closing.

Märklin M-turnouts 5100 and 5200 with sprung points

with double solenoid operation for remote control

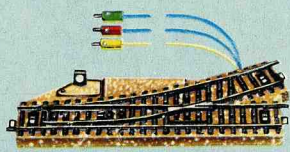
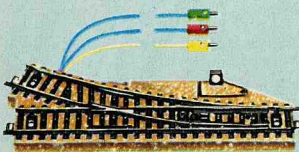

5202

Pair of solenoid-operated turnouts · Consisting of one right-hand and one left-hand turnout · Each with double solenoid · Working signal lights ·

Track lengths match those of track sections 5206 and 5106
 ⚡ = 60000

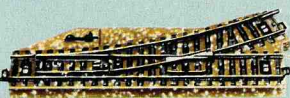

5221

Pair of manually-operated turnouts · Track dimensions as for 5202

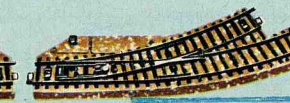
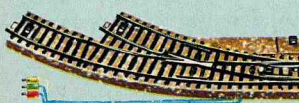

5140

Pair of solenoid-operated curved turnouts · Consisting of one right-hand and one left-hand inside curve turnout, each operated by double solenoid · Working signal lights · Length and curvature of tracks as for track section 5100 · Length of through track 265.4 mm
 ⚡ = 60000

If curved turnouts are included in the layout, trains can be switched from one track to another while still on the curve. The narrow interval (77.4 mm) between the parallel curves of the track is maintained, and the saving in space makes a longer overtaking section possible.



5137

Pair of solenoid-operated turnouts · Consisting of one right-hand and one left-hand turnout, each operated by double solenoid · Working signal lights · Length of the straight section 180 mm · Radius of

branch track 360 mm · Can be supplemented by the track section 5102 supplied, to equal section 5100
 ⚡ = 60000

5128

Double slip switch · Crossing angle 30° · Operated by double solenoid · Working electric signal lights which change to indicate the setting of the points (crossing or curve) · Hand lever to permit manual setting · Length of straight section 193 mm · The curve is the same as for track section 5100
 ⚡ = 60000

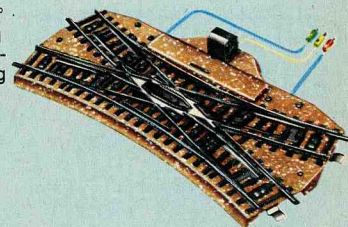

5207

Double slip switch · Enables the track spacing of 77.4 mm to be maintained · Operated by double solenoid · Hand-operating lever on actuator case · Length of straight section 180 mm · The curve is the same as for 5202, 5221 and 5206 · 2 make-up sections 5208, each 8 mm long, are included

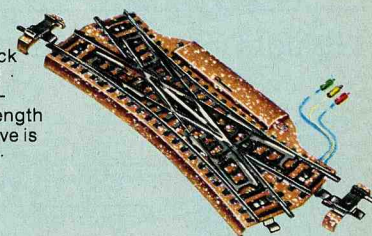

5214

Symmetrical three-way turnout operated by 2 double solenoids · 2 hand levers for manual setting of the two pairs of points · 5 connecting leads · Length of straight section 180 mm · Radius of the branch tracks 437.4 mm, the same as for the concentric circle · When used in conjunction with track section 5206, the 77.4 mm track center spacing can be maintained on both sides

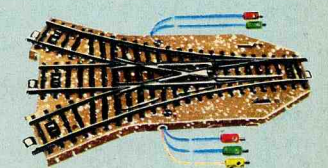

7190

Bumper, riveted steel type · Clipped on to 70 mm long track section

7299

Countersunk wood screws for mounting metal tracks · In packs of 200



7171

Sound absorbent strips in packs of 50 with 50 countersunk wood screws, for quiet train operation · If the track is laid out on a plywood board, the trains as they move naturally make a certain amount of noise, although not excessive, to the rhythm of the wheels · If it is desired to damp this noise down to about half, it is recommended that the tracks, turnouts and crossings should be laid on sound-absorbent strips · This makes no difference to the mounting of the catenary system

7191

Bumper, riveted steel type, with working signal light · Clipped on to 70 mm long track section
 ⚡ = 60000

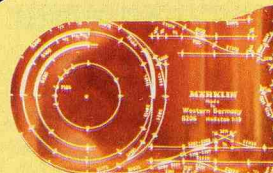

0206

Track planning template for Märklin HO gauge M-track sections (series 5100/5200) · Track sections, turnouts, crossings etc. are marked out in 1:10 scale on the template and they can easily be transferred onto paper using a sharp pencil

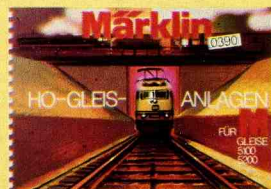

0392

Märklin track layouts, HO gauge, for M-tracks 5100 and 5200 · With full-color illustrations and detailed track plans of 16 layout suggestions · 56 pages

A full description of these brochures appears on page 62



0321

Märklin track layouts, HO gauge, for M-tracks 5100 and 5200 · Simple track plans · 24 pages

Märklin K-tracks 2100 (K=plastic ties)

The Märklin K-track, 2100 series, uses the same stud-contact system, the advantages of which were described on page 49. With this track the rails are laid on plastic cross-ties. The stud-contacts project through the ties from below, ensuring very reliable current pick-up. The six-fold connection between one track section and the next comprises rail jointing clips, sprung connectors for the center conductor and an additional claw coupling on the cross-tie. Coun-

tersunk wood screws 7599 (see page 53) are recommended for fastening the K-tracks to a base.

The five Märklin K-track circles:
 1 industrial circle 2110 = 8 track sections
 1 standard circle I 2121 = 12 track sections
 1 standard circle II 2131 = 12 track sections
 1 large circle I 2141 = 12 track sections
 1 large circle II 2151 = 12 track sections

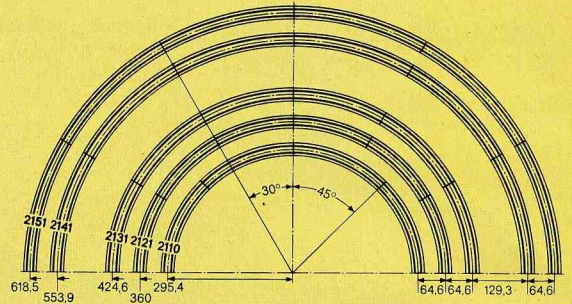

Straight track sections

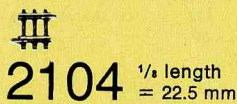
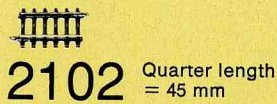
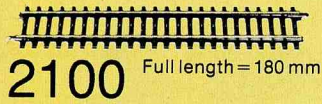

Straight make-up sections

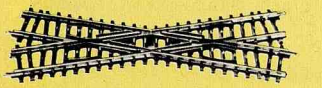
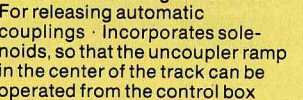
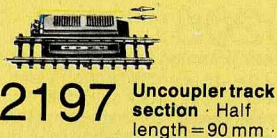
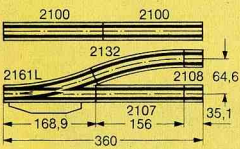
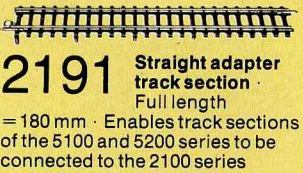
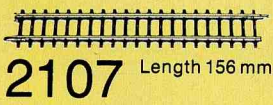
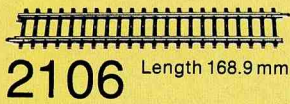
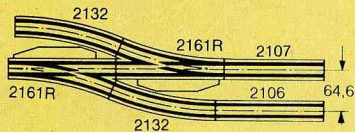

Curved track sections

Radius 424.6 mm · Standard circle II

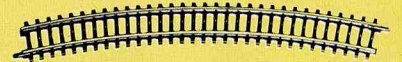

Radius 295.4 mm · Industrial circle

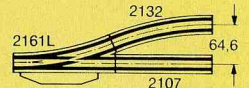
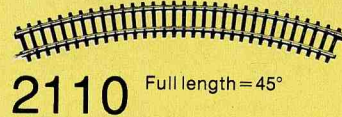

Radius 360 mm · Standard circle I

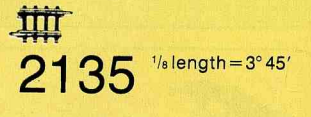
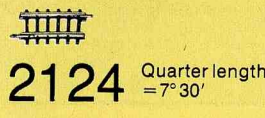
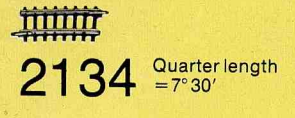
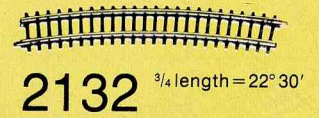
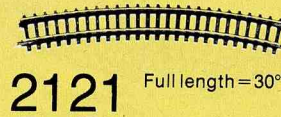

Using the switching track sections (2129, 2139 or 2199), solenoid-operated items can be controlled automatically by a moving train. Each track section, activated by the train's pick-up shoe, can trigger two different and independent switch functions, depending on the direction of motion.

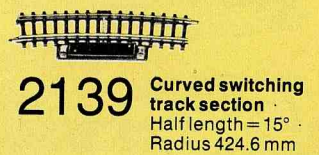

The control pulses are fed out via two terminals, isolated from each other.

Radius 553.9 mm · Large circle I

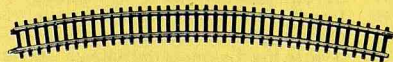

Radius 618.5 mm · Large circle II

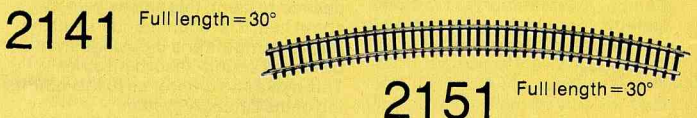

Märklin K-turnouts 2100 with sprung points

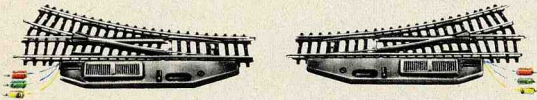

2161

Pair of solenoid-operated turnouts · Consisting of one right-hand and one left-hand turnout, each operated by

double solenoid · Working signal lights · Radius of branch track 424.6 mm · Length of straight track section 168.9 mm
 $\phi = 60000$

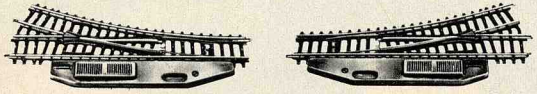

2164

Pair of manually-operated turnouts · Consisting of one right-hand and one left-hand turnout · Radius of branch

track 424.6 mm · Length of straight track section 168.9 mm · Operated by hand lever



2167

Pair of curved solenoid-operated turnouts · Consisting of one right-hand and one left-hand inside turnout operated by double solenoid · Length and

curvature of branch track are the same as for track section 2121 · Length of through track 244.6 mm

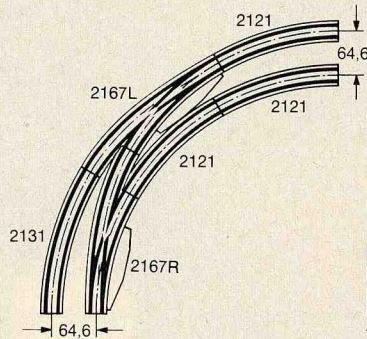

Example of use of 2167

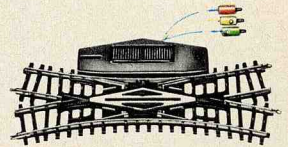

2160

Double slip switch · Radius 424.6 mm Inside points operated by double solenoids under remote control · Hand lever in addition · Length of straight track sections 168.9 mm

2170

Symmetrical three-way turnout operated by 2 double solenoids · 2 hand levers for manual setting of the two pairs of points · Length of straight track section 168.9 mm · Radius of branch tracks · 424.6 mm

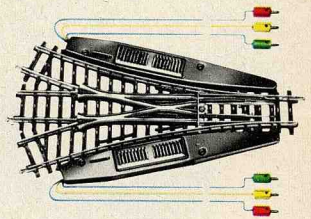

7391

Bumper, riveted steel type · For clipping onto the rails · Length 38 mm · Oval-head countersunk screw included



7500

Ground connector with terminal, for connecting the ground lead to 2100 series



7504

Connector for center conductor with terminal · Is pushed onto the contact strips at the joint of 2100 series track sections



7522

Center conductor isolator · Is fitted between the contact strips at the joint of 2100 series track sections, to separate the electrical circuits on each side

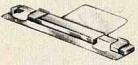

7599

Countersunk wood screws for fixing plastic tracks · In packs of 200

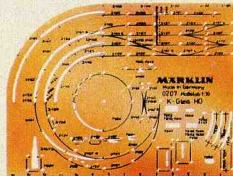

0207

Track planning template for Märklin K-tracks (2100 series), HO gauge · Track sections, turnouts, crossings etc. are marked out on the template and can easily be transferred onto paper with a sharp pencil



0372

Märklin track layouts, HO gauge, for 2100 series K-tracks · An outstanding guide · 52 pages



0379

Märklin track layouts, HO gauge, for 2100 series K-tracks · Simple track plans · 20 pages · For full description of these booklets see page 62

HO track patterns for K-tracks from publications 0372 and 0379

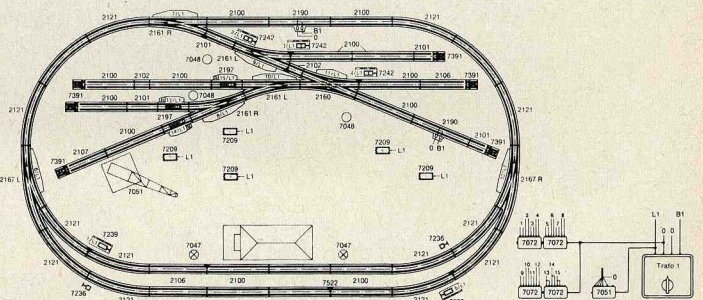

1 layout 155 × 90 cm, from 0372

16-2100	2-2161	4-7072	9-7000	38-7115	37-7132
4-2101	1-2167	5-7209	3-7101	15-7117	48-7135
2-2102	2-2190	2-7236	1-7102	38-7131	37-7137
3-2106	3-2197	2-7239	1-7103		
1-2107	2-7047	3-7242	1-7105		
14-2121	3-7048	6-7391	8-7111		
1-2160	1-7051		12-7112	1 transformer 30 VA	

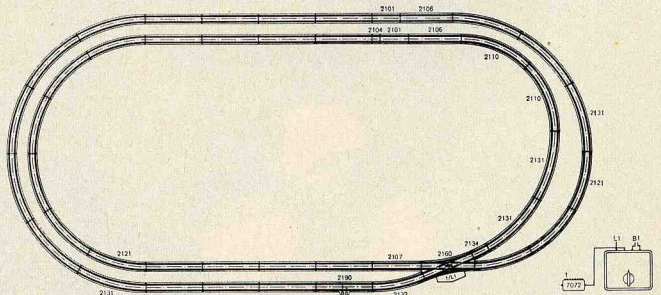

4 layout 186 × 90 cm, from 0379

15-2100	1-2107	1-2132	1-7072	2-7131	1-7102
2-2101	2-2110	1-2134	1-7111	1-7135	1-7105
1-2104	9-2121	1-2160			
2-2106	11-2131	1-2190	1 transformer 30 VA (16 VA)		

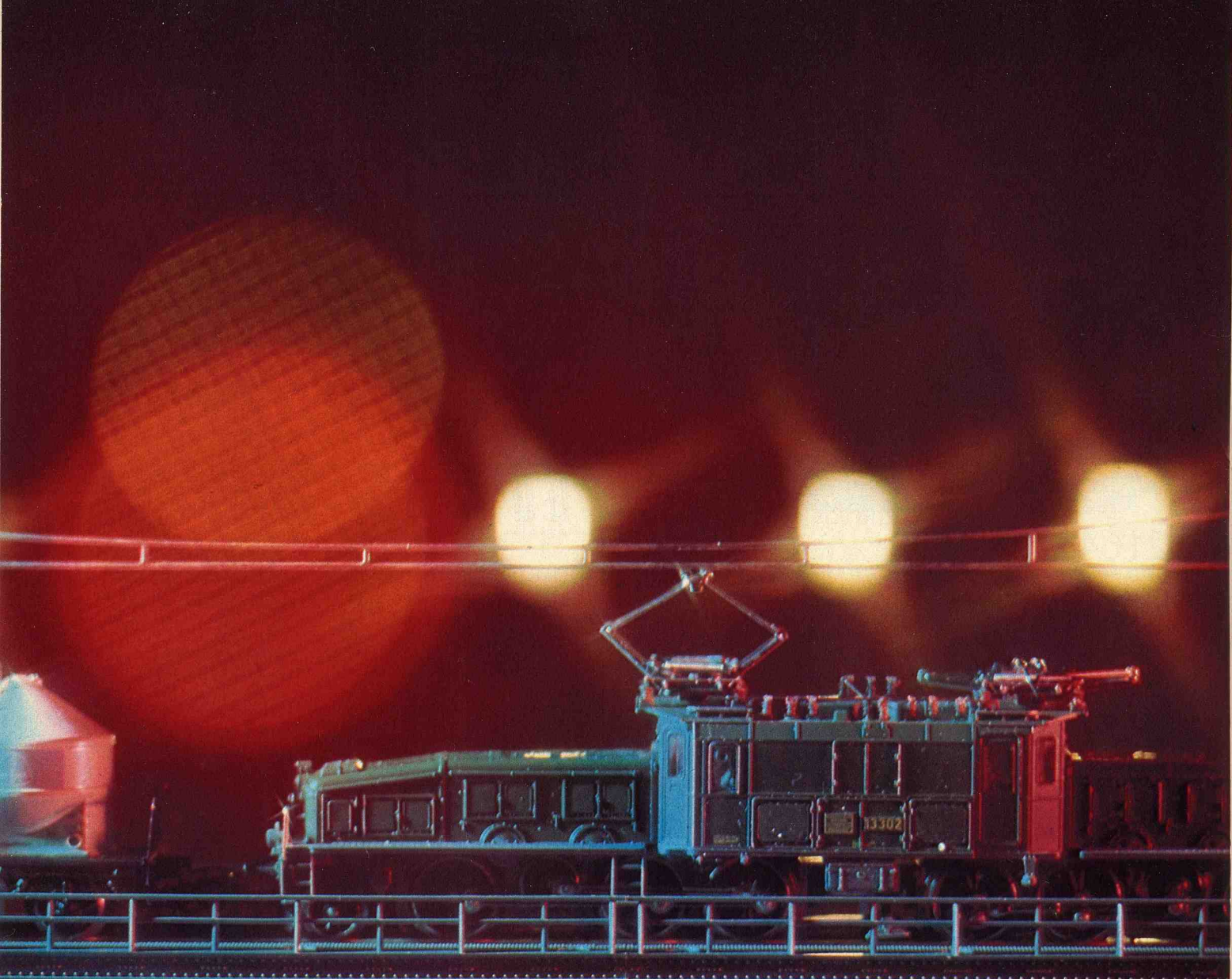

The Märklin range of signals for M-tracks

There should be a few suitably arranged signals, even on a small railroad layout, and not just because the play of red, green and amber lights looks so attractive. You can regulate the traffic by setting the signals to red and green, by remote control, and the signals can control the stopping and starting of the trains.

And that's not all: if you just include switching track sections and connect

them to the signals, one train can control another automatically via the signals without any chance of a collision (Block, or high density operation). In this way, while some trains travel in accordance with the program, you are free to see to other things, e.g. switching.

The installation of signals is simple. Their base plates are clamped under straight or curved metal track sections, and the leads are connected as shown in the instructions supplied. The signals are connected electrically to the control boxes (7072, see page 60) in such a way that it can be seen from the position of the push buttons whether the signals are at "stop" or "go".

Anyone who wants his layout to be realistic should install distant signals as well as the home signals described. They are mounted in the same way as home signals and are simply connected to them by a lead.

With one control box 7072 it is possible to operate, for example, 4 home signals 7039 together with their distant signals, and also groups of signals and turnouts.

Home and siding signals have traction current switches, which can be used to control the current in the track center conductor or overhead line.

The silver contacts in the switches enable them to cope with heavy loads.

The signal connector leads are fitted with color-coded plugs, which have side sockets for connecting a second plug. There are also sockets in the signal base for connection of the overhead line and grounding leads. Each pack includes small bulbs for the lighting system, insulators for the current conductor, a base plate and detailed installation instructions.

Distant signals without train control

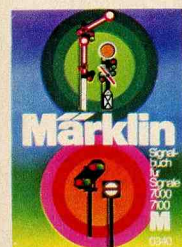

0342
Märklin signal manual for M-tracks · For detailed description see page 62

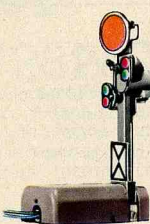

7036
Distant signal with movable disk · Signal lights change from amber/amber to green/green · Double solenoid · Used with home signal 7039 · Width 28 mm · Length 65 mm · Height 73 mm
⚡ = 60000



7038
Distant signal with movable disk and additional movable semaphore arm · Light sequence as for 7036 or from amber/amber to green · 2 double solenoids · Usually used with home signals 7040 or 7041 · Width 28 mm · Length 65 mm · Height 73 mm
⚡ = 60000

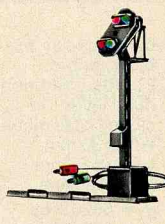

7187
Color light distant signal · Used only in conjunction with color light home signal 7188 · Signal lights change from green/green to amber/amber using 4 bulbs · Width 16 mm · Length 11 mm · Height 60 mm
⚡ = 60202 green
60204 orange

Signals with train control for catenary and track supply systems



7245
Universal remote control switch with 2 single-pole switches and one changeover switch for various circuits · It can do many kinds of job (up to 3 functions simultaneously), and will carry them out reliably and automatically · For example it can cause a moving train to switch station lighting on and off, or it can override the control of trains by signals for trains traveling in the opposite direction, or many other things · Lots of possible applications are shown in the signal manual 0342 and in the installation instructions · Operated by double solenoid · Can be actuated by switching track section, control box or hand lever · Width 30 mm · Length 70 mm · Height 8 mm



7039
Home signal with one semaphore arm · Signal light changes from red to green · Double solenoid · Width 27 mm · Length 70 mm · Height 125 mm
⚡ = 60000



7040
Home signal with 2 coupled semaphore arms · Signal lights change from red to green/amber · Double solenoid · Width 27 mm · Length 70 mm · Height 125 mm
⚡ = 60000

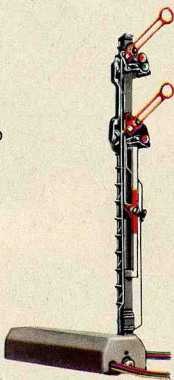

7041
Home signal with 2 independent semaphore arms · Signal lights change from red to green or red to green/amber · 3 solenoids · Width 27 mm · Length 97 mm · Height 125 mm
⚡ = 60000



7188
Color light home signal · Signal lights change from red to green · Double solenoid · Lighting by 2 bulbs · Additional hand control lever · Pair of sockets for connection of distant signal 7187 · Width 28 mm · Length 70 mm · Height 90 mm
⚡ = 60001 red
60002 green



7042
Yard and siding signal · Mast with movable front and rear disks · Double solenoid · Width 28 mm · Length 70 mm · Height 70 mm
⚡ = 60000

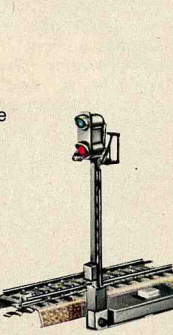

7339
Color light home signal · Signal lights change from red to green by manual operation, which at the same time controls the current to the section of metal track joined on to the signal · Additional track section 90 mm long with interrupted central conductor · Width 55 mm · Length 90 mm · Height 90 mm
⚡ = 60001 red
60002 green



5004
Connecting lead for central conductor · Length 750 mm



5022
Center conductor isolators for 5 isolation points

Märklin signals 7200 for K + M-tracks

The color light home signals and siding signals of the 7200 series have switches which enable them to control traction current in the catenary system and the track center conductor independently. The signal masts, and the lighting unit of yard + siding signal 7242 can be separated from the traction current switch units and set up by themselves. The bracket 7230 is then required for fixing the masts. Ground connection is by the base plates or leads supplied, and via the leads when used with 2100 series track sections, and via the leads when used with 5100 and 5200 series track sections.

7236

Color light distant signal · Signal lights change from amber/amber (Vr0) to green/green (Vr1) using 4 bulbs · Only for connection to the color light home signal 7239 · Includes fixing bracket 7230 and base plate · Width 16 mm · Length 28 mm · Height 67 mm

⚪ = 60202 green
60204 orange



7237

Color light distant signal · Signal lights change from amber/amber (Vr0) to amber/green (Vr2) using 4 bulbs · Only for connection to the color light home signal 7240 · Includes fixing bracket 7230 and base plate · Width 16 mm · Length 28 mm · Height 67 mm

⚪ = 60202 green
60204 orange



7238

Color light distant signal · Signal lights change from

amber/amber (Vr0) to green/green (Vr1) or amber/green (Vr2) using 4 bulbs · Double solenoid operation for the amber/green setting · For use with color light home signal 7241 · Includes base plate · Width 30 mm · Length 70 mm · Height 67 mm

⚪ = 60202 green
60204 orange

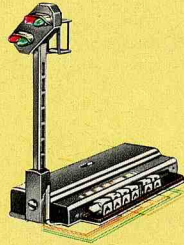

7239

Color light home signal · Signal lights change from red (Hp0) to green (Hp1) and traction current

controlled by double solenoid · 2 bulbs · Additional hand lever · Includes base plate · Width 30 mm · Length 70 mm · Height 90 mm

⚪ = 60201 red
60202 green

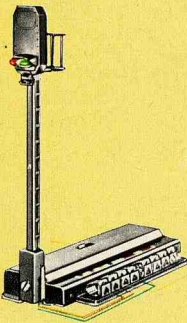

Center conductor isolators, center conductor connectors and installation instructions are included with home signals 7239, 7240 and 7241.

7240

Color light home signal · Signal lights change from red (Hp0) to green/amber (Hp2) and traction current

control by double solenoid operation · 3 bulbs · Additional hand lever · Includes base plate · Width 30 mm · Length 70 mm · Height 90 mm

⚪ = 60201 red
60202 green
60204 orange

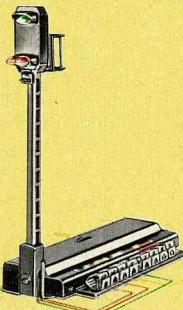

7241

Color light home signal · Signal lights change from red (Hp0) to green (Hp1) or green/amber (Hp2), and

traction current control by double solenoid operation, with an additional solenoid for the green/amber setting · 3 bulbs · 2 hand control levers in addition · Includes base plate · Width 30 mm · Length 95 mm · Height 90 mm

⚪ = 60201 red
60202 green
60204 orange

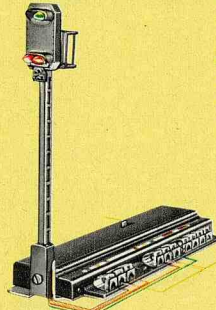

7230

Fixing bracket · Is required if the mast of light signals 7238, 7239, 7240, 7241 and the yard + siding signal 7242 are set up separated from the traction current control units



7242

Yard and siding signal, dwarf version · Signal lights change from red/red (Sh0) to white/white (Sh1), with traction current control by double solenoid operation · Two light bulbs provide the signal lights · Additional hand control lever · Width 30 mm · Length 70 mm · Height 18 mm

⚪ = 60200

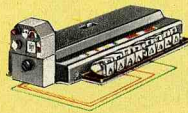

7245

Universal remote control switch with 2 single pole switches and one changeover switch for various circuits · It can do many kinds of job (up to 3 functions simultaneously), and will carry them out reliably and automatically · For example it can cause a moving train to switch station lighting on and off, or it can override the control of trains by signal for trains traveling in the opposite direction, or many other things · Lots of possible applications are shown in the signal manual 0361 and in the installation instructions · Operated by double solenoid · Can be actuated by switching track section, control box or hand lever · Width 30 mm · Length 70 mm · Height 8 mm

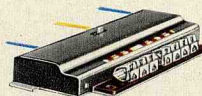

7539 for K-tracks only

Color light home signal · Signal lights change from red (Hp0) to green (Hp1) by manual operation, with simultaneous control of the traction current in the track section joined on to the signal · An additional 90 mm long track section with interrupted center conductor · Width 50 mm · Length 90 mm · Height 90 mm

⚪ = 60001 red
60002 green

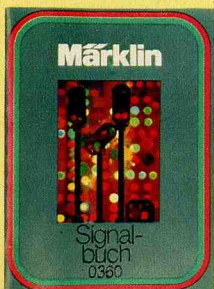
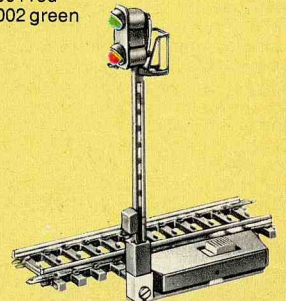

0361

Märklin signal manual for K-tracks · For detailed description see page 62

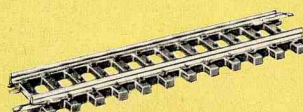

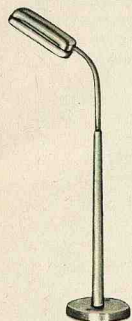

7280
Street lamp stand-
ard · Height
117 mm · Base
diameter 25 mm
☹ = 60000

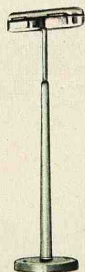

7281
Station platform
lamp standard ·
Twin armed ·
Height 97 mm ·
Base diameter
25 mm
☹ = 60000

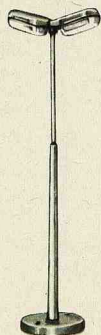

7282
Street lamp stand-
ard · Twin armed ·
Height 120 mm ·
Base diameter
25 mm
☹ = 60000

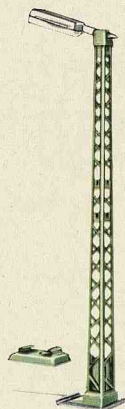

7283
Lattice mast light ·
Mounted on a lat-
tice mast · With
base plates for
mounting on
tracks · Can be
used with catenary
system · Height
170 mm
☹ = 60000



7284
Sidewalk lamp
standard · Height
63 mm · Base
diameter 15 mm
☹ = 60000

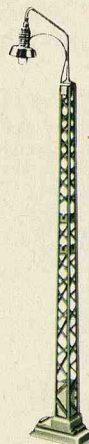

7046
Arc light with lat-
tice mast · Can be
used with catenary
system for
M-tracks · Height
192 mm · Base
14 × 28 mm
☹ = 60010



7047
Lamp standard ·
Height 127 mm ·
Base diameter
27 mm
☹ = 60010

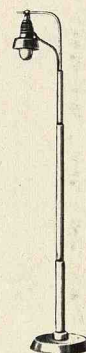

7048
Arc light · Height
156 mm · Base
diameter 29 mm
☹ = 60010



Märklin catenary system for M-tracks 5100/5200



7009
Catenary mast · Basic element · Height 100 mm

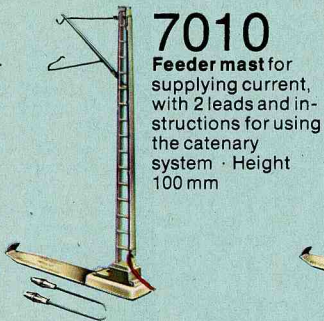

7010
Feeder mast for supplying current, with 2 leads and instructions for using the catenary system · Height 100 mm



7012
Feeder mast for signals, with one lead · Height 100 mm

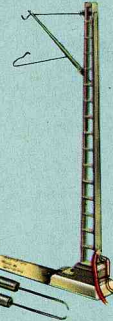

7201 Feeder mast for supplying current, with 2 permanently connected leads, one red, one brown · Additional brown lead · Built-in capacitor for radio interference suppression · Instructions for setting up the catenary system are included · Height 100 mm

7005 Catenary set for train control for signals of the 7000 series which are not mounted on tower masts · Consisting of 2 feeder masts 7012, 2 insulator sections 7022 and 2 overhead wire contact sections 7014

Electric locomotives can draw current from the overhead line with the same reliability and positive electrical contact as from the track center conductor stud contacts. On the locomotive, all that has to be done is to change over the position of a small lever. With the Märklin system it makes no difference which way round the locomotive is put on the track. It's a good idea to connect the catenary system to a separate transformer, as two trains can then be run independently on the same track, one using the overhead line and one the track stud contacts.

The overhead contact wires with their tensioning and cross span connectors are arranged exactly like the real thing. That is why the Märklin catenary system looks so realistic, spanning the open stretches of railroad and especially around stations. The contact wire sections can be used with both M-tracks and K-tracks. The sprung contact wire holders on the masts ensure reliable contact with the contact wires.

The push-fit connectors, on contact wire sections 7013 and 7023, for example, enable the contact wires to be slid together to make up the right length.

The contact wires are flexible and can adapt to any curve without the need for special fittings. The longest contact wire section 7019 was designed for use on long straight sections.

Using the tower masts 7021 and the cross spans 7016 it is possible to span the widest of station or yard track complexes. For 4 tracks one cross span and two tower masts are required, then one cross span and one tower mast for every 4 additional tracks. For single tracks outside a pair of masts, the overhead line can be suspended from the cantilever support arm 7525.

Märklin catenary system for K + M-tracks

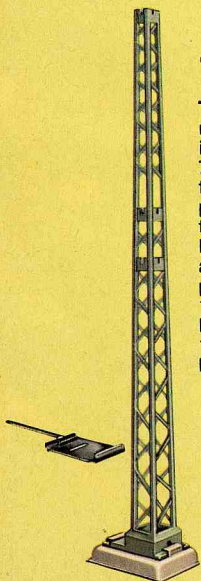

7021
Tower mast with recesses for hooking in cross spans 7016 or 7017 and the cantilever support arm 7525 for the overhead line. For tower mast with arc light see page 57 · Height 157 mm with M-tracks and 154 mm with K-tracks



7511
Bridge mast · For attaching to the side of plastic bridges and ramp sections · Height 97 mm

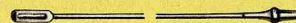

7003
Catenary system connector lead for connection to signals when tower masts are used and for supplying current to any point · Length 600 mm

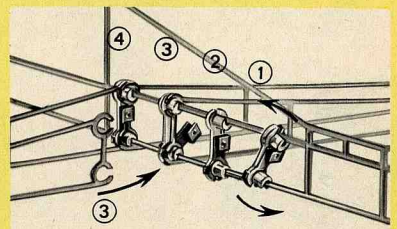

7004
Fastening kit · Consisting of 5 bolts, 5 nuts and 5 washers · Used only in exceptional cases where it is not possible to make a reliable contact by the usual method of assembly

7006
Contact wire insulation · For insulating sections of contact wire from cross spans · One required for each track and cross span · 15 x 6 mm



7013
Contact wire section for push-fit connection, especially for use at turnouts · Length 240 mm



7014
Contact wire section · Female portion (for push-fit connection) · Length 115 mm



7015
Contact wire section · Male portion (for push-fit connection) · Length 115 mm

All contact wire sections are nickel-plated.

Märklin catenary system for K-tracks 2100



7509
Catenary mast · Basic unit for the construction of a catenary system over track sections of the 2100 series · Height 97 mm

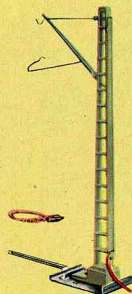

7510
Feeder mast with a red lead and plug attached to the mast · Brown lead with plug · Includes instructions for setting up the catenary system · Height 97 mm

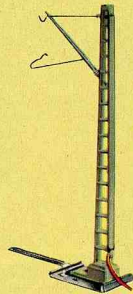

7512
Feeder mast with a red lead attached, for connecting the catenary system to the home signals · Height 97 mm

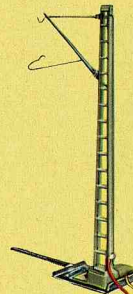

7501
Feeder mast with two permanently attached leads, one red, one brown · Built-in capacitor for radio interference suppression · Includes instructions for setting up the catenary system · Height 97 mm

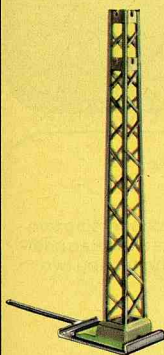

7524
Lattice mast with recesses for hooking on one or two cantilever support arms 7525 · Height 96 mm

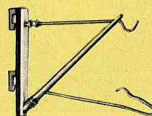
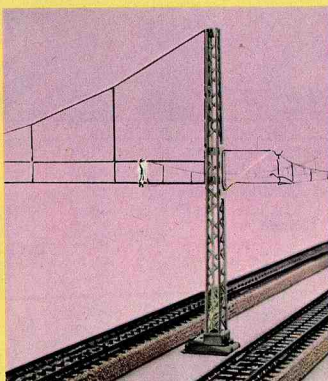

7525
Cantilever support arm for suspending single or double overhead contact wires, in conjunction with tower mast 7021 or lattice mast 7524 (see illustration)

7505
Catenary set for train control for 7200 series color light home signals which are not mounted on tower masts · Consisting of 2 feeder masts 7512, 2 interrupted track sections 7022 and 2 contact wire sections 7014 · For use with 2100 series track sections

Märklin catenary system for K + M-tracks

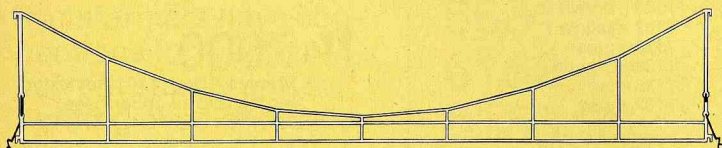

7016
Cross span · For hooking into tower masts · Spans about 4 tracks · Span 390 mm

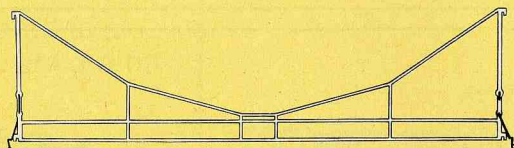
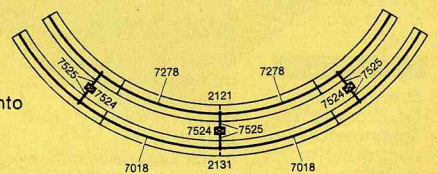

7017
Cross span · For hooking into tower masts · Spans about 3 tracks · Span 280 mm

7278
Contact wire section for use over the inner track curve on curved double track sections of the 2100 series · Length 235 mm (see illustration)



7018
Contact wire section for straight and curved track sections · Length 270 mm

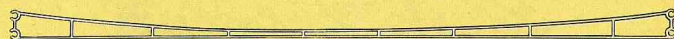

7019
Contact wire section for straight track sections only · Length 360 mm



7022
Insulator section · Male portion (for push-fit connection) for interrupting the overhead line current · Length 115 mm



7023
Make-up section for push-fit connection · Length 100 mm

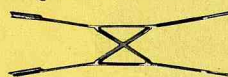

7277
Crossing section for 2158, 2159, 2160, 5114, 5128, 5207 and 5211

All contact wire sections are nickel-plated.

Using contact wire sections 7014, 7015 and 7023 it is possible to make up any length from 177 to 360 mm. The push-fit

connections can be strengthened if necessary using the fastening kit 7004 (see illustration).





Usual colors of electrical leads in Märklin circuits:



Red = traction current connection (from transformer to track center conductor or overhead line)



Yellow = lighting and solenoid-operated items



Blue = return lead from solenoid-operated items to control box or switching track (with green, red and orange plugs)



Brown = ground lead from tracks, lighting sockets or control box to transformer

Electrical leads

The copper conductor in these stranded leads consists of 24 separate strands each of 0.10 mm diameter, giving an overall cross-sectional area of 0.19 mm². That is adequate even for carrying a short-circuited 40 VA transformer current.

7100 Lead · Single core · Gray · 10 m

7101 Lead · Single core · Blue · 10 m

7102 Lead · Single core · Brown · 10 m

7103 Lead · Single core · Yellow · 10 m

7105 Lead · Single core · Red · 10 m

Sleeves



7111 = brown
7112 = yellow
7113 = green
7114 = orange
7115 = red
7117 = gray

Plugs with side sockets



7131 = brown
7132 = yellow
7133 = green
7134 = orange
7135 = red
7137 = gray

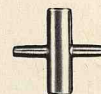

7140

Plug adapter for connecting two sleeves or sockets and as an additional means of connecting two plugs



7073

Lamp socket with bulb and lead for stations, freight sheds, etc.
⚡ = 60020



7000

Staples · Bag of 50 · For fastening leads to a wooden base

Accessories for remote operation

Circuit diagram of 7210 (with switch 3 closed)

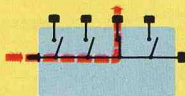

Circuit diagram of 7211 (with switch 3 closed)



7072

Control box with 8 sockets for connecting 4 double-solenoid-operated articles · The position of signals, turnouts etc. can be seen from the position of the push buttons · Length 80 mm · Width 40 mm



7210

Control box with indicator push buttons for distributing current to 4 leads for traction of lighting circuits · Length 80 mm · Width 40 mm



7211

Control panel for switching 4 different traction or lighting circuits on and off by indicator push buttons · Length 80 mm · Width 40 mm



7209

Distribution strip · With 11 single sockets · Size 50 × 20 mm



7229

Distribution strip with 5 lead terminals, permanently connected together · Length 38 mm · Width 10 mm

The Märklin heavy-duty transformers

Every Märklin transformer is completely safe, with insulation which has been tested to several thousand volts. Furthermore, a built-in overload cut-out switches off the current if a short-circuit occurs on the layout or if the transformer is overloaded. The transformer has a lead and a plug for connection to an a.c. mains socket or standard lamp.

Locomotive speed is proportional to the traction voltage, i.e. when the red control knob is turned to the right the locomotive goes faster, when to the left, slower. If the control knob is turned momentarily to the left of the zero position, a nominal 24 volt pulse operates the reversing switch (the "engineer") in the locomotive and changes the direction of motion.

We guarantee trouble-free operation of our railroads only when genuine Märklin transformers are used.

Märklin 16 VA and 30 VA transformers have connections for traction current supply and for lighting or solenoid-operated items

To be connected to alternating current mains supply only

Power consumption by locomotives and lights

Calculation examples:
this is how to calculate the number of items which can be connected to the transformer: the 3-axle tank locomotive 3000 takes about 9 VA, the express diesel locomotive 3021 and the heavy express steam locomotive 3085 each take about 12 VA. Any margin of power left over after accounting for the locomotives can be used for train or layout lighting, counting 1 VA for each bulb used.

The transformers in the gift packs, mentioned on page 9, have the same good features as the transformers discussed here, the only difference being that their power output is less.

Transformer · Output 16 VA · Traction voltage adjustable between approximately 4 V and 16 V · Lighting voltage 16 V · Plastic case · Weight 1.2 kg · Dimensions 125 × 135 × 75 mm

For particular requirements we stock transformers under the following numbers:

- 6660 100 Volt Japan
- 6666 110 Volt
- 6667 110 Volt USA
- 6669 240 Volt England
- 6671 220 Volt

When ordering, please quote the number corresponding to the required mains voltage.

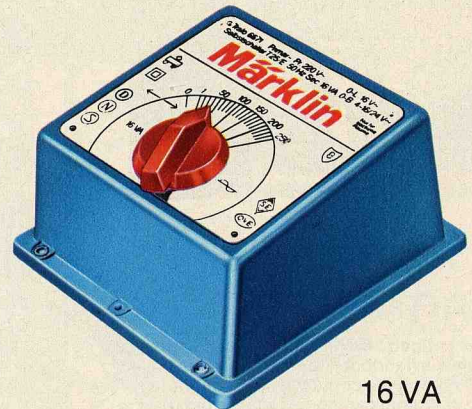

16 VA

Transformer · Output 30 VA · Traction voltage adjustable between 4 and 16 V · Lighting voltage 16 V · Plastic case · Red pilot lamp · Weight 2.1 kg · Dimensions 158 × 135 × 75 mm
⊙ = 60015

For particular requirements we stock transformers under the following numbers:

- 6620 100 Volt Japan
- 6625 125 Volt
- 6629 240 Volt England
- 6631 220 Volt
- 6152 110 Volt
- 6153 110 Volt USA



30 VA

When ordering, please quote the number corresponding to the required mains voltage.

Transformer for lighting

- 6611 220 Volt

Transformer for lighting and for solenoid-operated items · Output 40 VA · Output voltage approximately 16 V a.c. · Plastic case · Weight 2.0 kg · Dimensions 158 × 135 × 75 mm

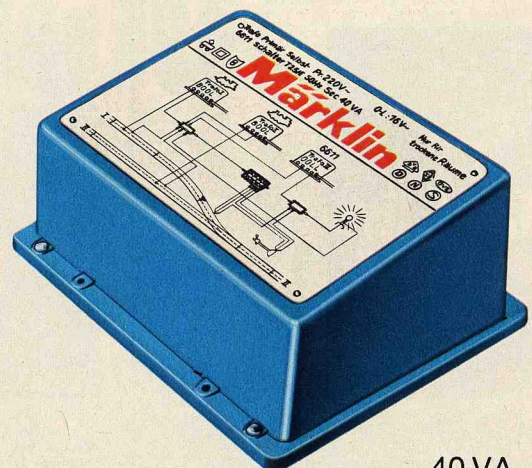

40 VA



0380

Booklet entitled "Märklin HO railroads and their originals", a handbook for Märklin model railroads. Among the contents: suggestions for designing and landscaping model railroad layouts, the Märklin locomotives and cars and the originals on which they are modeled, signals, railroad regulations and procedures, examples of circuits, e.g. for simultaneous operation of several trains, and much more besides. Contents 228 pages. Size 15 × 24 cm. German text

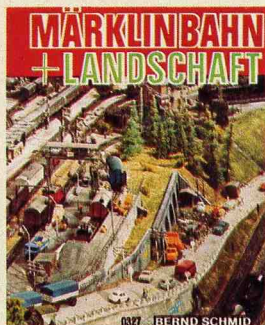

0327

Booklet entitled "Märklin railroad + landscape", by Bernd Schmid. An outstanding aid in designing your own railroad system. The construction of an HO gauge system is discussed in the finest detail. The book has many illustrations, including some in color. Technical details, track layout, landscape planning and the fitting out of a railroad system are treated in detail by a well-known model railroad expert. An invaluable source of information for any model railroader. Contents 192 pages. Size 16.4 × 20.3 cm. German text

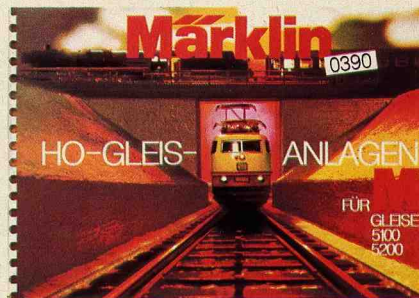

0392 M

Booklet entitled "Märklin track layouts, HO gauge, for M-tracks 5100 and 5200". With full color illustrations and detailed track plans for 16 fully developed track examples with catenary systems. The individual electrical circuits are marked in distinguishing colors. The accompanying text includes many examples of track and turnout combinations. An outstanding guide for the construction of layouts of any size. Contents 56 pages. Size 21 × 30 cm. English text

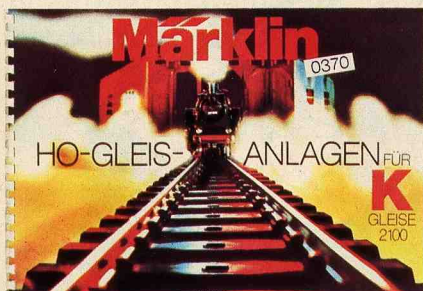

0372 K

Booklet entitled "Märklin track layouts, HO gauge, for K-tracks 2100". With full color illustrations and detailed track plans for 16 fully developed track examples with catenary systems. The individual circuits are marked in distinguishing colors. The accompanying text includes many examples of track and turnout combinations. An outstanding guide for the construction of layouts of any size. Contents 52 pages. Size 21 × 30 cm. English text



0379 K

Booklet entitled "Märklin track layouts, HO gauge, for K-tracks 2100". Contains 7 simple track plans. Contents 20 pages. Size 15 × 21 cm. English text



0321 M

Booklet entitled "Märklin track layouts, HO gauge, for M-tracks 5100 and 5200", with 11 simple track plans. These layouts are easy to construct and can be used in many interesting ways. Contents 24 pages. Size 15 × 21 cm. English text

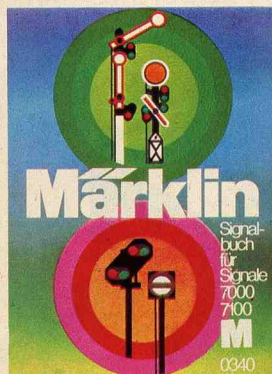

0342 M

Märklin signal manual for signals 7000 and 7100. A detailed explanation, with full color illustrations, of the installation and use of 7000 and 7100 series signals and universal remote control switch with the M-track system. Contents 28 pages. Size 18 × 25 cm. English text

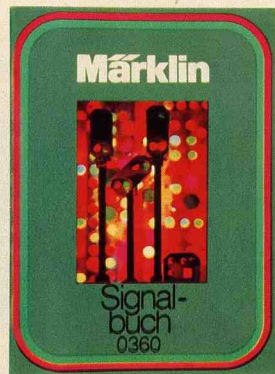

0361 K

Märklin signal manual for signals 7200. A detailed explanation with six-color illustrations, of the installation and use of signals and universal remote control switches of the 7200 series. Contents 48 pages. Size 18 × 25 cm. English text

Märklin booklets are available from your Märklin dealer

The Märklin range, with its mini-club, HO and I gauge programs provides a broad basis for a meaningful use of your leisure time. The Märklin magazine is geared to this wide-ranging stock. It caters for all levels of sophistication in model construction, having suggestions both for beginners and for the "old hands" with years of experience. Every aspect of model railroad engineering receives appropriate coverage in each issue. Layout planning experts, locomotive constructors and control specialists all contribute. Subjects dealt with range from straightforward supplementing of Märklin models to the construction of your own vehicles, and from elementary control aids to electronic sensor-operated braking-and-acceleration units made with modern semiconductor components. Integrated controls and luminescence diodes (now within everyone's price range) are being discussed more and more frequently. Under the heading "Märklin owners report", readers of Märklin magazine all over the world describe their layouts, frequently giving each other new ideas. New products useful for modeling, such as materials and tools, appear on a special page. Articles about real railroads in various countries, and about narrow-gauge, rack drive and museum railroads, as well as reports from the German Federal Railways, all assist you to achieve a truly realistic railroad system.

The Märklin magazine is published in German, four times a year—in mid February, May, September and November. A subscription brings a whole year's worth of valuable and interesting information to your home.

Obtainable from
Modellbahnen-Welt Verlags-GmbH
Postfach 940, D-7320 Göppingen
or from your Märklin dealer or
through bookshops.

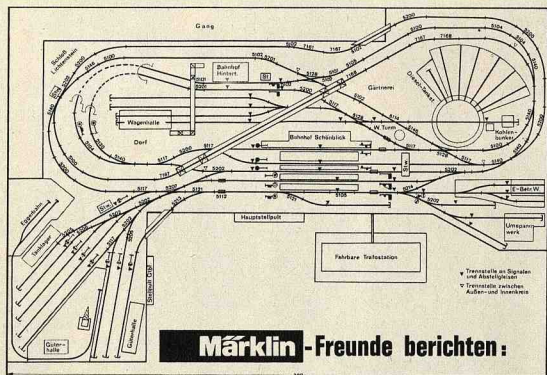

7-gm-HO-Anlage mit „Spezialkran“

„Lange Zeit zählte auch ich zu den bedauerwerten Modellbahnern, die mit ihrer Anlage ein Nostalgieasien in ihrer Wohnung führen müssen. Um den Stein des Anstoßes ein für allemal aus dem Wege zu räumen, habe ich in dem kürzlich bezogenen Einfamilienhaus im Keller einen 12 qm großen Raum mit einem überdimensionierten Fenster als Hobbyraum bezogen. Es wurde eine Heizung installiert und ein Holzfußboden mit Linoleumbelag verlegt, so daß mein Freizeit-Dorado keinen Anlaß mehr für ein Familienpöbeln bieten kann. In mehreren Etappen entstand eine Anlage - siehe Gleisplan (Abb. 1) -, auf der 58 m Gleis, davon 42 m mit Oberleitung, 34 Weichen, 8 Hauptgarnituren, 9 Vorleitgarnituren, 10 Gleisversignaturen, 6 Entkopplungsgleisstücke, 1 Drehscheibe und 1 Kran installiert sind. Im wesentlichen besteht sie aus einem Außen-

und einem Innenkreis sowie 2 Kehrschleifen, von denen eine mit einer Hängebrücke (Abb. 2) von 106 cm Spannweite und 144 cm Gesamtlänge den ganzen Mittelteil der Anlage überspannt. Im Inneren der Ringstrecke befinden sich Abstellgleise für Personenzüge. Hier habe ich auch ein Dampf- und ein Diesel-BW platziert (Abb. 3). Ersteres weist einen Ringlokschuppen und eine um ein Gleis erweiterte Drehscheibe auf (siehe auch „Mehr Gleisanschlüsse für unsere Märklin-Drehscheibe“ auf Seite 14). Außerhalb der Ringstrecke besetzt noch ein Eilok-BW mit 6 Ständen, das - ebenso wie die beiden Ringlokschuppen - aus Sperrholz, Leisten, Pappe und Falls-Mauerplatten und -Feuertern in nützlicher Kleinarbeit selbst gestrickt wurde (Abb. 4). Im rechten Winkel zum Hauptteil hat links (Abb. 1) ein Güterbahnhof mit rund 8 m Abstellgleisen,



Abb. 2: Hängebrücke mit Hängebrücke

19

Die Dampf-Lokomotiven der Baureihe

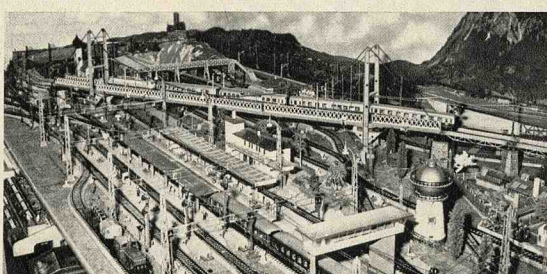

Abb. 2: Die 95 285 am Lok-Schuppen im Bw Wann-Eigen. Foto: Hans Schmidt

050

Es, die „Fuffziger“ - lohnt es sich überhaupt, an diese Lokomotivgattung kostbaren Platz im Märklin-magazin zu verschwenden? Jedermann kennt sie doch, jeder hat sie schon fotografiert. Es erfordert wenig Mühe, sie zu sehen, denn selbst das anliegende Dampf-BW hat eine 050 im Schuppen stehen. Und sollte einmal die letzte deutsche Dampflok den letzten Auspuffstoß zum Himmel schicken, so steht hundert gegen eins zu werten, daß er aus dem Schornstein einer 050 kommt. Noch vor Jahren hat der Eisenbahnfreund diese Lok kaum für voll genommen. Sie fuhr enim ja ständig über den Weg; unsere legt galt ganz anderen Raritäten.

So ändern sich die Zeiten. Heute sind wir glücklich, gelingt es uns, eine 050 im Betrieb zu beobachten, denn sie gehört zu den ganz wenigen noch Dienst versahenden Dampfloktypen. Und je geringer deren Zahl, desto größer das Interesse. Eigentlich verfahren wir ungerecht mit dieser bewährten, tüchtigen Lokomotivbaureihe. Kaum eine andere Type hat so viele Varianten geboten, bei keiner anderen gab es bauliche Unterschiede, die fast unübersehbar zu sein scheint. Es wäre eine lohnenswerte Aufgabe, einmal die Metamorphose dieser Loktype von der Baureihe 50 zur aus ihr entwickelten Kraglokbauart der Baureihe 52 in allen Einzelphasen festzuhalten. Rechneten wir dem hinzu, was nach dem zweiten Weltkrieg aus Ersatzteilen zusammengebastelt, umgebaut, rekonstruiert, neubekesselt und wiederum neugebaut wurde, dann gäbe das Stoff für einen spannenden, abendfüllenden Film über ein interessantes Kapitel Lokomotivgeschichte. Versuchen wir, uns wenigstens einen groben Überblick über das Lebensschicksal dieser Loktype zu verschaffen. Das Projekt einer leichten Güterzuglokomotive - und als solche gilt ja unsere 050 - geht auf die Jahre 1836/37 zurück. Nach Überwindung der großen Wirtschaftskrise hatte das Verkehrsministerium eine lebhafte Aufschwung genommen, besonders im Güterverkehr. Diesen Anforderungen zeigte sich die preußische G 10, BR 57^{1/2}, nicht mehr voll gewachsen. Sie war im Jahre 1910 entstanden und auch während des ersten Weltkrieges weitergebaut worden. Materialfehler und kriegsbedingte Ersatzstoffe bewirkten eine erhöhte Reparaturanfälligkeit, die Ausmusterungen nahmen zu. Die Entwurfsarbeiten für eine Ersatzlok wurden ausgeschrieben und vorgegeben; die neue Lok sollte weitgehend den anderen Einheitsloks angepaßt sein. Mit der vorgesehenen 1'E-Achsfolge glaubte man auch auf Nebenstrecken bei großer Zugkraft höhere Geschwindigkeiten erreichen zu können, denn hierfür war die neue Lok zunächst gedacht. Deshalb durfte die mittlere Achslast 15 t nicht überschreiten. Da auf Nebenbahnen die Drehscheiben vielfach nur für kleine Tenderlokomotiven bemessen waren, sollte der Tender der neuen Lok so entworfen werden, daß die Maschine auch rückwärts mit der vorgesehenen Höchstgeschwindigkeit

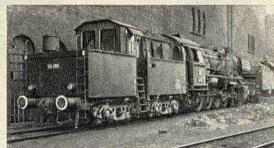
Abb. 1: Die „050“ in Original-Vorkriegsausführung

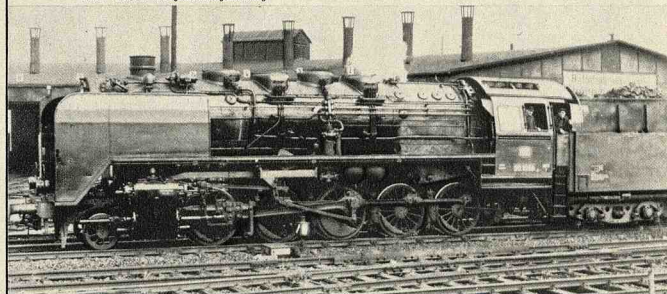



mini-club, the great leisure activity

Mini-club exposes you to high-grade Märklin precision engineering and a lot of fun in a concentrated package. The small track gauge, only 6.5 millimeters, enhances your pleasure in the exact details and perfect operation of the models.

Mini-club is easy to carry around, and it can be set up in lots of different ways. It can operate in the space of a drawer; you can take it with you in your suitcase when you go visiting or on vacation. The mini-

club range is already extensive and is continuing to grow. It offers maximum scope for individuality in planning and operating a railroad. On the other hand, building up with the logical SET extension stages is an equally effective way of achieving a comprehensive and yet compact layout.

Many accessories are available to add interest and realism to your railroading. Or you may have your own bright ideas: quite ordinary little ob-

jects can assume fascinating proportions when used as landscaping in a mini-club operation.

It's not without reason that the Märklin mini-club continues to attract fans. You ought to treat yourself (or a friend) to this unique, beautiful little railroad. Mini-club's popularity continues to grow. The traditional Märklin attention to detail and insistence on high quality makes sure of that. There is just no alternative to mini-club.

mini-club, the smallest series produced railroad in the world

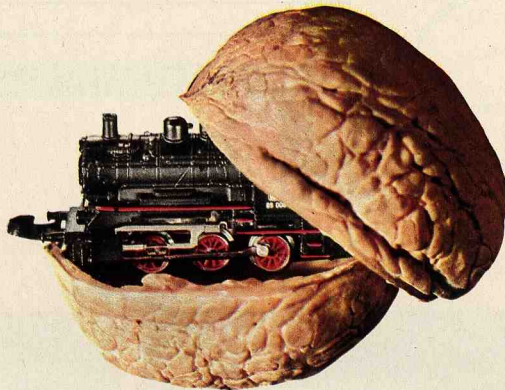

This locomotive is depicted in its actual size.

Mini-club locomotives should only be operated with Märklin power pack nos. 6711 or 6720—6731 (max. traction voltage 8 V).

Our suggestion
for an ideal
start:

Märklin mini-club
SET 123 with
Toporama 8930

This layout consists of basic sets S 8905—8909 or 8902, extension sets E 8190 or E 8191, double track set T 1 8192, station track set T 2 8193, switching track set T 3 8194 = SET 123 and Toporama 8930. See page 68 for track plan and parts list for this layout. See also pages 66—69.

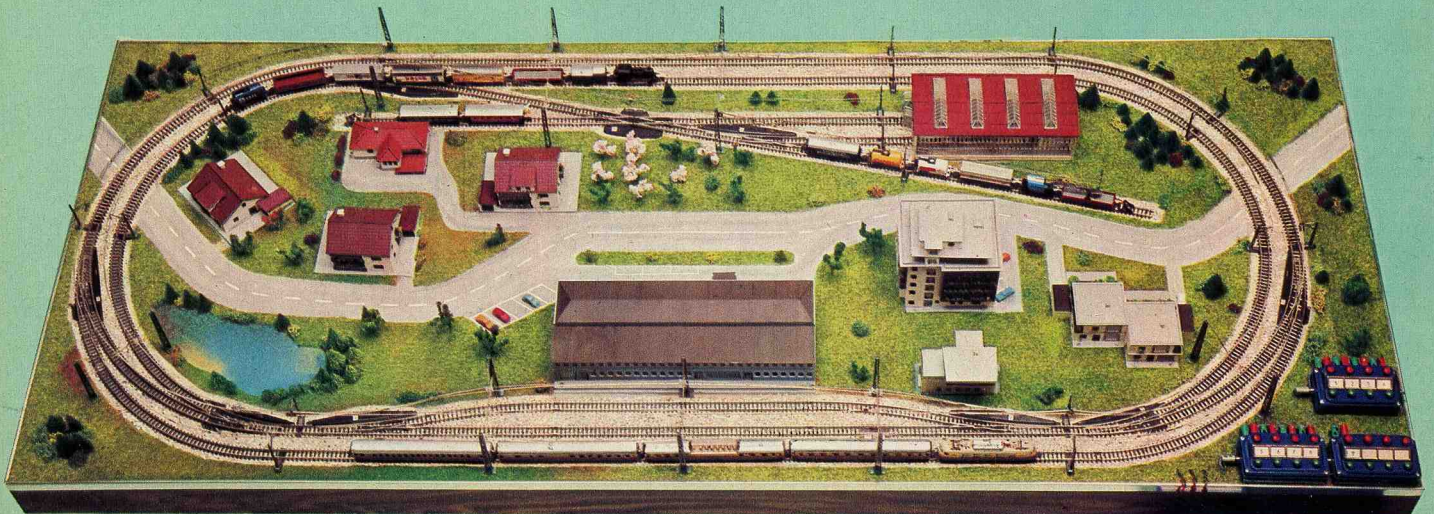

The starting point is a gift set S either with freight train with power pack S 8905-8909 or express train without power pack S 8902.

Each of these gift sets contains track sections to form an oval track (see page 69).

The first extension stage is an extension set E 190 or extension set E 8191.

From here on, there are three more extension sets for building up to the ideal mini-club layout:

- double track set T 1 8192
- station track set T 2 8193
- switching track set T 3 8194

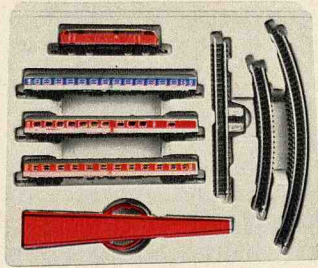

Express train without power pack S 8902

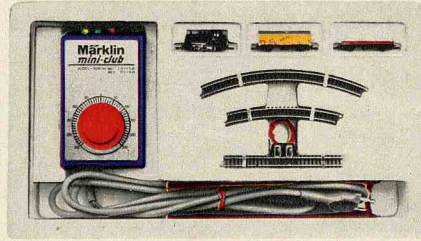

Freight train with power pack S 8905-8909

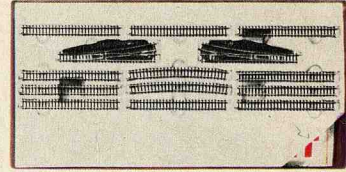

8190

Extension set E - Contents: 10 straight track sections 8500, 1 pair manually-operated turnouts 8564, 2 curved track sections 8591 and instructions for extending the layout

mini-club SET

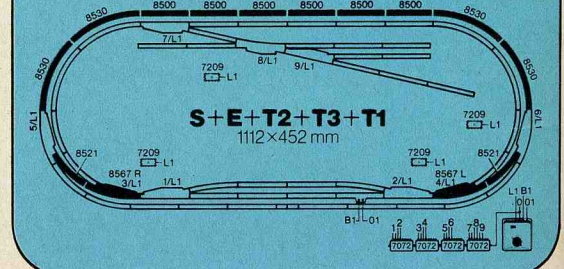
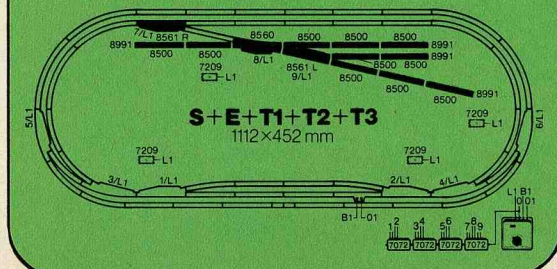
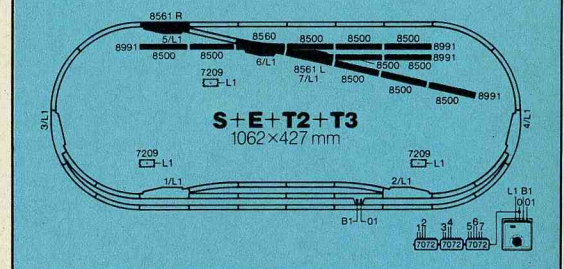
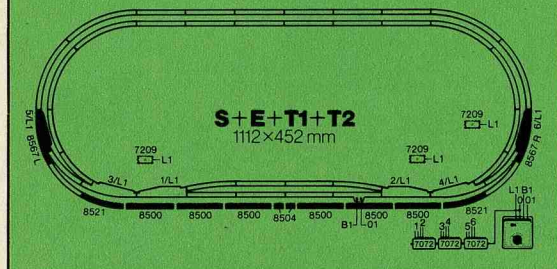
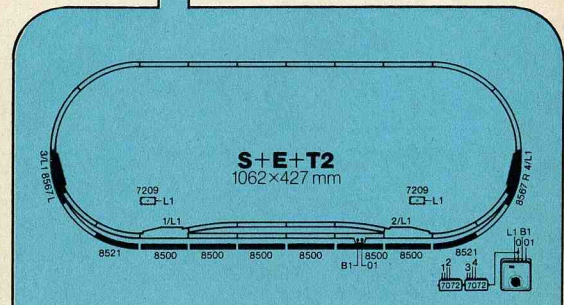
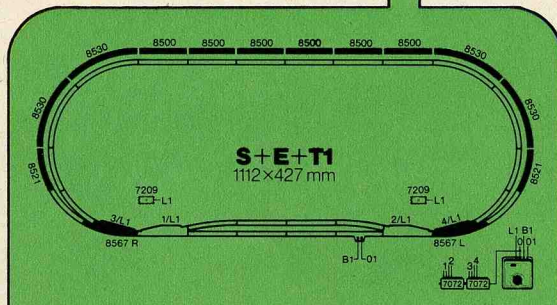
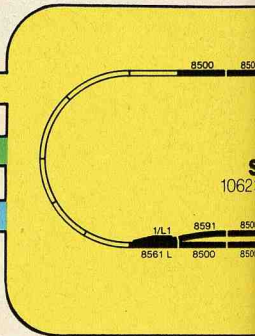
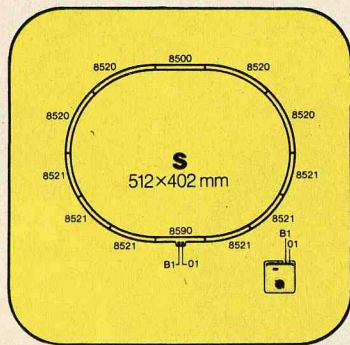

The three track sets T 1, T 2 and T 3 can be added in any order. Here we show just four possible ways in which a small beginning can lead to the ideal mini-club layout. Depending on how you prefer to operate your railroad, you can use one of these schemes or think up a variation of your own. Building up to the ideal mini-club layout by using the Märklin mini-club SET extension program is as easy as that.

The culmination of the Märklin mini-club SET extension program is the addition of the mini-club catenary system. You will find a very interesting suggestion about this on page 68.

Märklin mini-club SET, the way to the ideal mini-club layout

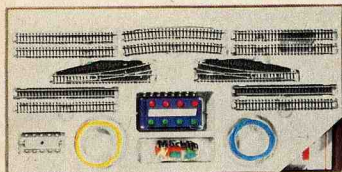

8191
Extension set E · Contents: 10 straight track sections 8500, 1 pair of solenoid-operated turnouts 8561, 2 curved track sections 8591, 1 control box 7072, 1 distribution strip 7209, plus materials for making connectors, such as leads, sleeves and plugs · Instructions for extending the layout

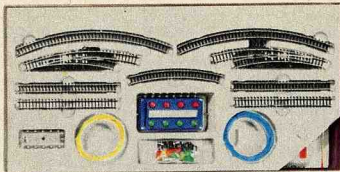

8192
Double track set T1 · Contents: 6 straight track sections 8500, 2 curved track sections 8521, 4 curved track sections 8530, 1 pair of solenoid-operated curved turnouts 8567, 1 control box 7072, 1 distribution strip 7209, plus materials for making connectors, such as leads, sleeves and plugs · Instructions for extending the layout

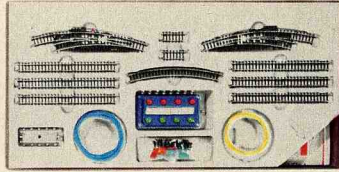

8193
Station track set T2 · Contents: 6 straight track sections 8500, 2 straight track sections 8504, 2 curved track sections 8521, 1 pair of solenoid-operated curved turnouts 8567, 1 control box 7072, 1 distribution strip 7209, plus materials for making connectors, such as leads, sleeves and plugs · Instructions for extending the layout

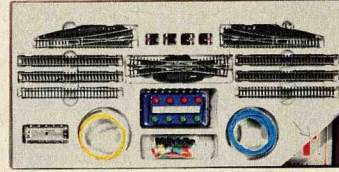

8194
Switching track set T3 · Contents: 10 straight track sections 8500, 1 double slip 8560, 1 pair of solenoid-operated turnouts 8561, 4 bumpers 8991, 1 control box 7072, 1 distribution strip 7209, plus materials for making connectors, such as leads, sleeves and plugs · Instructions for extending the layout

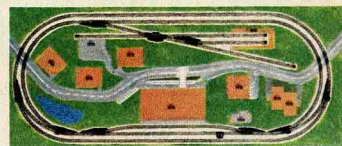
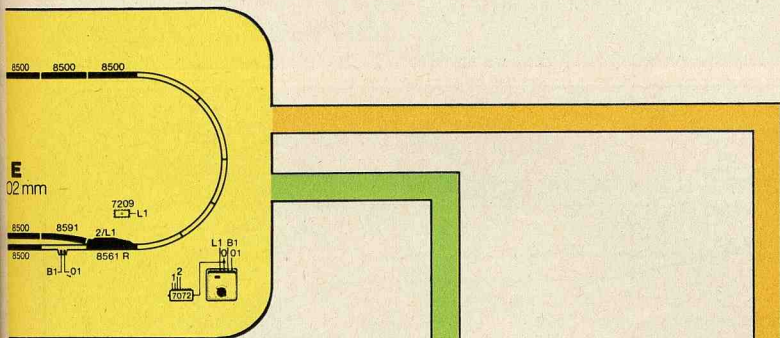

8930
Märklin mini-club-Toporama for mini-club SET extension program leading to the ideal track layout · Realistic printed model railroad landscape · Multicolor printing including simulated tracks · Can be used from stage E (8190, 8191) onwards · Tufted grass areas give three-dimensional effect · Size 50 × 120 cm

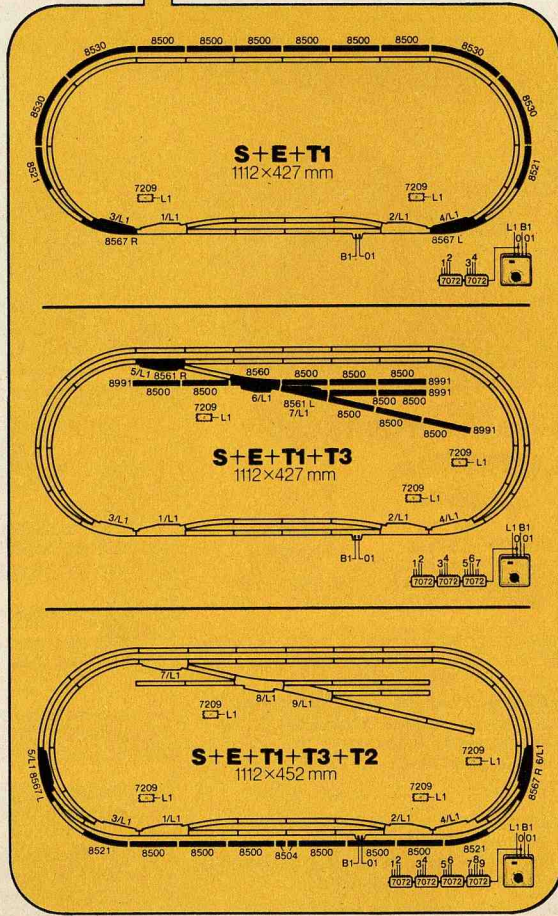
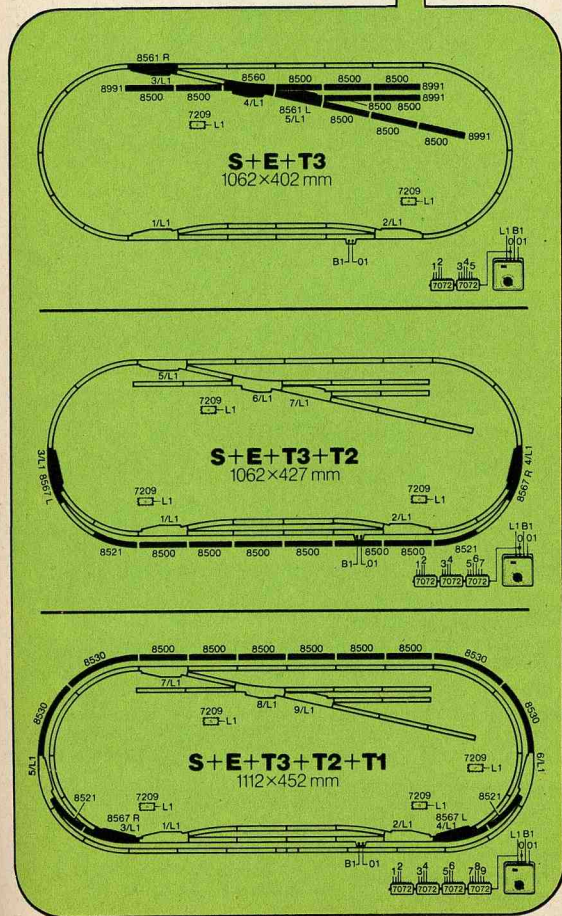

Märklin Toporama 8930 is highly recommended as a way of enhancing Märklin mini-club SET. The Toporama can be used from stage E (8190, 8191) onwards. The track layout up to stage T3 (8194) is pre-printed.

And how is the Toporama used?

Quite simple: the Toporama mat is laid, or glued, or fastened onto a base plate, the track is laid in accordance with the full scale printed layout, the connections are made and you are ready to roll. No other landscaping is needed, as the Toporama includes fields, streams, lakes, roads and parking lots.

Track current supply system

The following items are required for the construction of the ideal Märklin mini-club SET 123 layout:

- | | |
|---------|--------|
| 33-8500 | 4-7072 |
| 2-8504 | 4-7209 |
| 4-8520 | 1-7101 |
| 10-8521 | 1-7103 |
| 4-8530 | 4-7112 |
| 1-8560 | 9-7113 |
| 2-8561 | 9-7115 |
| 2-8567 | 4-7117 |
| 1-8590 | 4-7132 |
| 2-8591 | 9-7133 |
| 4-8991 | 9-7135 |
| | 4-7137 |

1 mini-club power pack

See page 65 for photograph of this track plan

120 × 50 cm

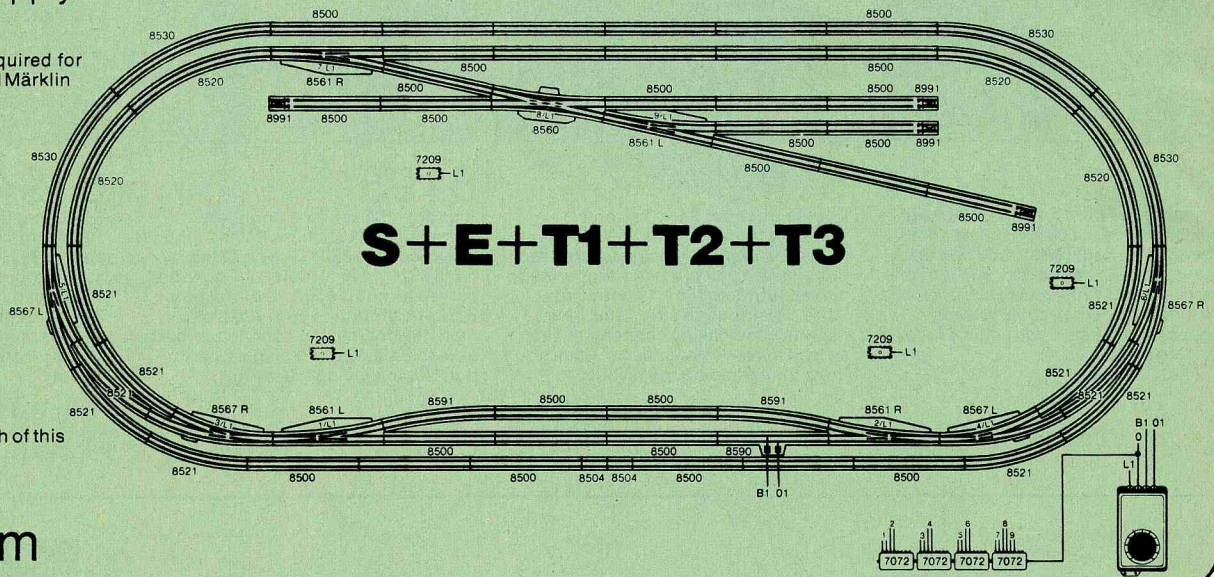

Catenary current supply system

- | | |
|---------|--------|
| 22-8911 | 2-8924 |
| 1-8912 | 6-8925 |
| 16-8914 | 1-8926 |
| 3-8921 | 1-8927 |
| 15-8922 | |
| 35-8923 | |

1 mini-club power pack

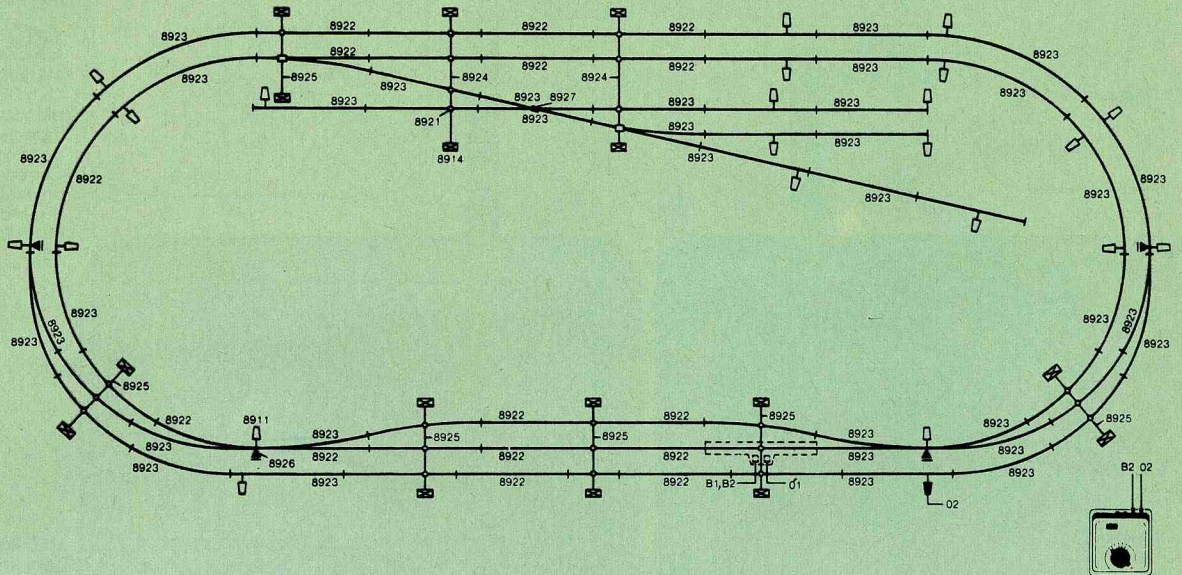

Explanation of symbols on track plans

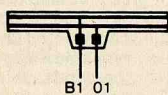

Track current supply system

B1 01
Feeder track section
One red and one brown lead from the terminals to terminals B and O on power pack 1.

3
Blue lead with green plug into the green socket; blue lead with red plug into the red socket of (for example) the pair of sockets marked "3" on the control box.

L1
Yellow lead to the yellow lighting voltage socket L on power pack 1 or the distribution strip L1 connected to it.

Catenary current supply system

Mast for overhead line 8911

Tower mast 8914 with cross spans 8924 or 8925 and white contact line insulator, for 2 contact lines, from 8921.

Tower mast 8914 with cross spans 8924 or 8925 and gray contact line insulator, for 3 contact lines, from 8921.

Gray isolating section with connecting spring, from 8926

Contact line terminal, without lead, from 8927

O2 = traction current connection for catenary system. Brown lead goes to the brown terminal on power pack 2.

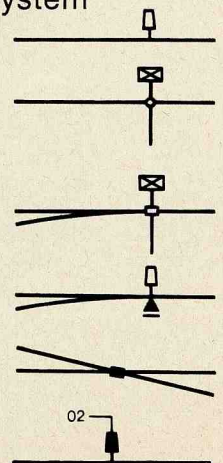

All you want to know at a glance:

Märklin mini-club has the gauge designation Z (6.5 mm). Märklin mini-club is powered by direct current. Everything carrying the name mini-club is of proven Märklin quality and is as strong, durable and effective as all the other Märklin railroads.

The locomotives are fitted with radio interference suppressors. In conjunction with the suppressors built-in the Märklin power packs 6711 and 6720–6731 and in the feeder track section 8590, these ensure that suppression standards are complied with.

Mini-club locomotives should only be operated with Märklin power pack 6711 or 6720–6731 (max. traction voltage 8 V) or with a power pack included in the gift sets.

- 8905 S** 100 Volt Japan
- 8907 S** 110 Volt USA
- 8908 S** 240 Volt Australia
- 8909 S** 220 Volt

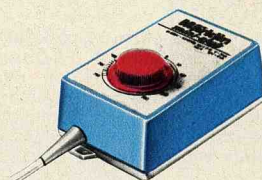

Freight train with power pack · With tank locomotive 8800, banana car 8606, low sided car 8610, 1 straight track section

8500, 4 curved track sections 8520, 6 curved track sections 8521, feeder track section 8590 and power pack · Length of train 160 mm

The power pack included with this set is not available separately.



8902 S

Express train (without power pack)
With diesel locomotive 8875, express coach 8720, express coach 8721, express dining car 8723, 1 straight track section

8500, 4 curved track sections 8520, 6 curved track sections 8521, feeder track section 8590 and re-railing ramp 8974 · Length of train 445 mm

For train sets 8905–8909 and 8902 we recommend Märklin mini-club SET, the extension program teaching to the ideal mini-club layout (see pages 65–68).

Märklin mini-club cars come in transparent packs. Make sure that the brand name "Märklin mini-club" appears on the pack.



Märklin mini-club train sets and locomotives can be recognised by the characteristic club packs with their wood grain pattern.



8800

Tank locomotive · A model of the 0-6-0 class 89 locomotive · 3 driven axles · Remote control for forward and reverse drive · Mat black metal body · Die cast zinc frame · Automatic coupling at each end · Length over buffers 45 mm

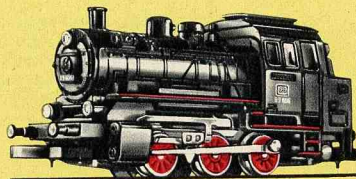

The illustrations of locomotives are actual size.

8864

Diesel locomotive · A model of the German Federal Railways' 0-6-0 class 260 locomotive · 3 driven axles · Remote control for forward and reverse drive · Red metal body · Silver-colored roof · Die cast zinc frame · Automatic coupling at each end · Length over buffers 49 mm

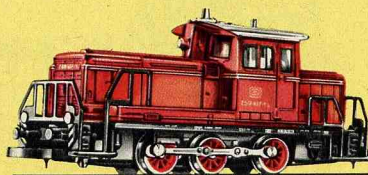

8895 **new**

Tank locomotive · A model of the German Federal Railways' 2-6-0 class 74 locomotive · 3 driven axles · Remote control for forward and reverse drive · Three working headlights · Mat black metal body · Die cast zinc frame · Hook coupling in front · Automatic coupling at rear end · Length over buffers 55 mm

🔗 = 8953

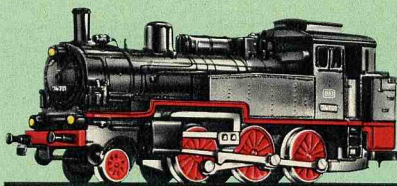

8803

Passenger train locomotive with tender · A model of the German Federal Railways' 2-6-0 class 24 locomotive · 3 driven axles · Remote control for forward and reverse drive · Capable of taking the lighting set 8953 for three headlights · Mat black metal body · Die cast zinc frame · Automatic coupling on the tender · Length over buffers 82 mm

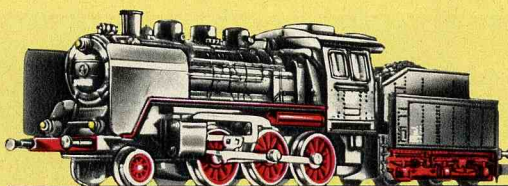

8885

Express train locomotive with tender · A model of the German Federal Railways' 4-6-2 class 003 locomotive · 3 driven axles · Remote control for forward and reverse drive · Three working headlights · Mat black metal body · Die cast zinc frame · Automatic coupling on the tender · Length over buffers 112 mm

🔗 = 8953

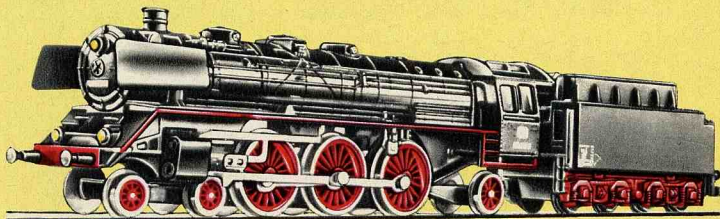

8827

Freight train locomotive with tender · A model of the German Federal Railways' 2-8-2 class 41 locomotive · 4 driven axles · Remote control for forward and reverse drive · Three working headlights · Mat black metal body · Die cast zinc frame · Automatic coupling on the tender · Length over buffers 112 mm

🔗 = 8953

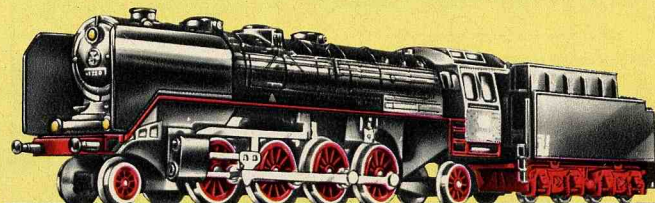

8854

Electric express locomotive · A model of the German Federal Railways' C-C class 103 locomotive · Both trucks driven · Remote control for forward and reverse drive · Three working headlights at each end, changing over with change in direction · Plastic body in the TEE colors beige and red · Roof aluminum-colored · Windows inset in plastic

frames · 2 spring-loaded pantographs on roof · Changeover switch for selecting power supply by overhead line or from the track · Die cast zinc frame · Automatic coupling at each end · Length over buffers 88 mm

Ⓚ = 8953



8858 new

Electric freight train locomotive · A model of the German Federal Railways' C-C class 151 locomotive · Both trucks driven · Remote control for forward and reverse drive · Three working headlights at each end, changing over with change of direction · Plastic body in turquoise and beige · Windows inset in plastic frames · 2 spring-loaded pantographs on

roof · Changeover switch for selecting power supply by overhead line or from the track · Die cast zinc frame · Automatic coupling at each end · Length over buffers 88 mm

Ⓚ = 8953

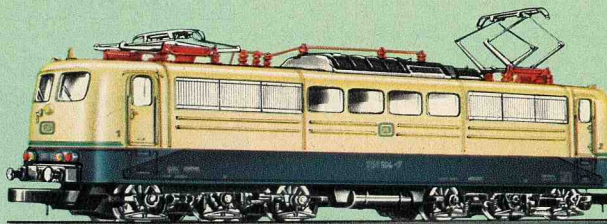

8857

Electric freight train locomotive · A model of the German Federal Railways' C-C class 151 locomotive · Both trucks driven · Remote control for forward and reverse drive · Three working headlights at each end, changing over with change of direction · Green plastic body · Windows inset in plastic frames · 2 spring-loaded pantographs on roof ·

Changeover switch for selecting power supply by overhead line or from the track · Die cast zinc frame · Automatic coupling at each end · Length over buffers 88 mm

Ⓚ = 8953

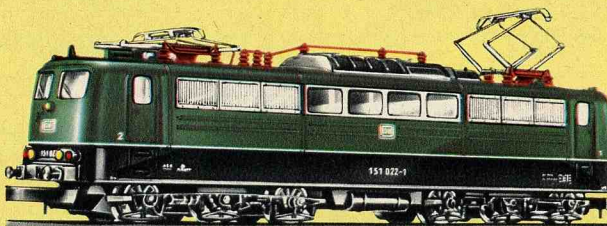

8874 new

Diesel locomotive · A model of the German Federal Railways' B-B class 216 locomotive · All axles driven · Remote control for forward and reverse drive · Three working headlights at each end, changing over with change of direction · Plastic body in turquoise and beige · Die cast zinc frame · Automatic coupling at

each end · Length over buffers 75 mm

Ⓚ = 8953

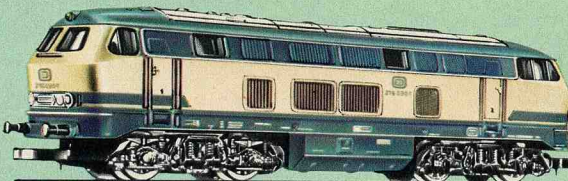

8875

Diesel locomotive · A model of the German Federal Railways' B-B class 216 locomotive · All axles driven · Remote control for forward and reverse drive · Three working headlights at each end, changing over with change of direction · Plastic body in red and gray · Die cast zinc frame · Automatic coupling at each end · Length over buffers 75 mm

Ⓚ = 8953

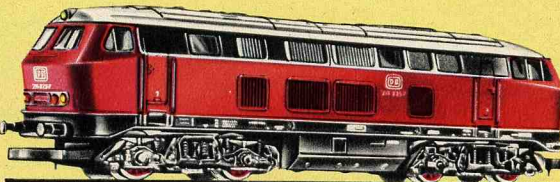

8816

Railbus · A model of the German Federal Railways' type 798 · Both axles driven · Remote control for forward and reverse drive · Three working headlights at each end · Red plastic body · Die cast zinc frame · Length over buffers 62 mm

Ⓚ = 8953

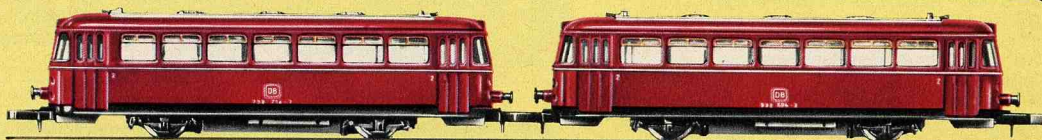

8817

If the train includes more than one trailer, a further motorized unit must be used.

Trailer for railbus · A model of the German Federal Railways' type 998 · Three

working headlights at each end · Red plastic body · Length over buffers 62 mm

Ⓚ = 8953

Express coaches

Local passenger service coaches

8710

Express coach · 1st class · A model of the German Federal Railways' type A üm · Windows inset in plastic frames · Length 120 mm



8711

Express coach · 2nd class · A model of the German Federal Railways' type B üm · Windows inset in plastic frames · Length 120 mm



8712

Express luggage car · A model of the German Federal Railways' D üm · Windows inset in plastic frames · Length 120 mm



8713

Express dining car · A model of the German Federal Railways' type WR üm · Windows inset in plastic frames · Length 120 mm

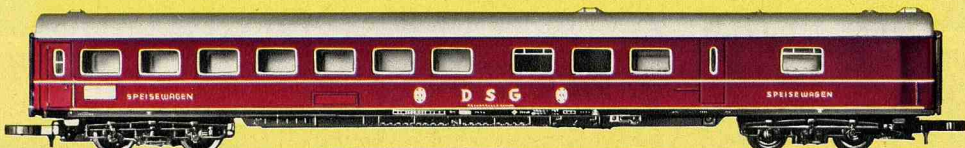

8720

Express coach · 1st class · A model of the German Federal Railways' type A üm · Windows inset in plastic frames · Length 120 mm



8721

Express coach · 2nd class · A model of the German Federal Railways' type B üm · Windows inset in plastic frames · Length 120 mm



8722

Express luggage car · A model of the German Federal Railways' type D üm · Windows inset in plastic frames · Length 120 mm



8723

Express dining car · A model of the German Federal Railways' type WR üm · Windows inset in plastic frames · Length 120 mm



8716 new

Local passenger service coach · 2nd class · A model of the German Federal Railways' type Bnb · Car body stainless steel-colored with peacock's-eye pattern · Windows inset in plastic frames · Length 120 mm

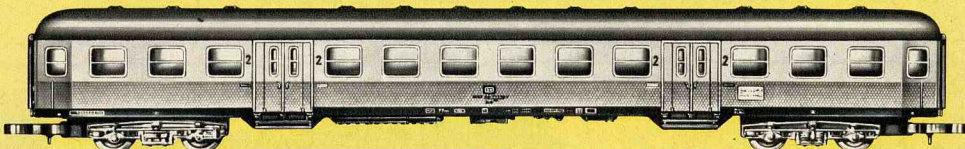

8717 new

Local passenger service coach · 1st and 2nd class · A model of the German Federal Railways' type ABnb · Car body stainless steel-colored with peacock's-eye pattern · Windows inset in plastic frames · Length 120 mm

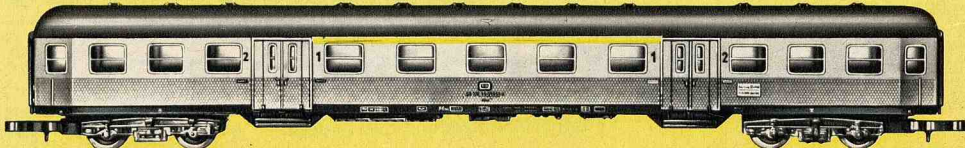

TEE coaches

Secondary line passenger coaches

8724

TEE compartment coach · 1st class · A model of the German Federal Railways' type Avm · Windows inset in plastic frames · Length 120 mm

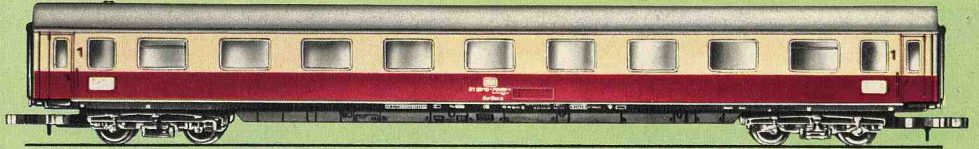

8725

TEE open-interior coach · 1st class · A model of the German Federal Railways' type Apm · Windows inset in plastic frames · Length 120 mm

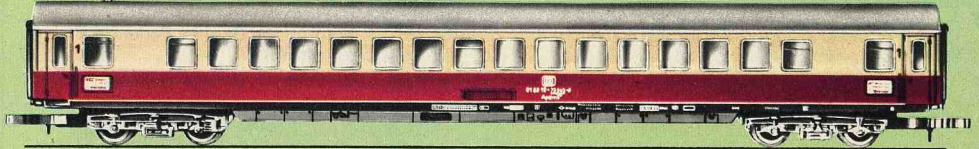

8726

TEE dining car · A model of the German Federal Railways' type WRm · Windows inset in plastic frames · Length 120 mm

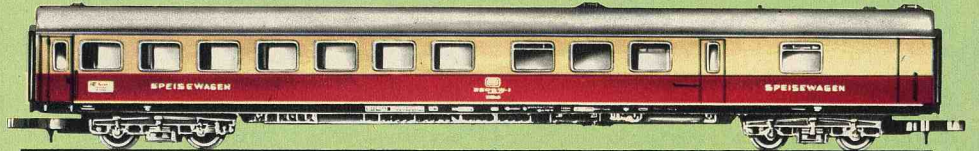

8728

TEE dome car · 1st class · A model of the German Federal Railways' type (ADm) · Windows inset in plastic frames · Transparent plastic observation dome · Length 120 mm

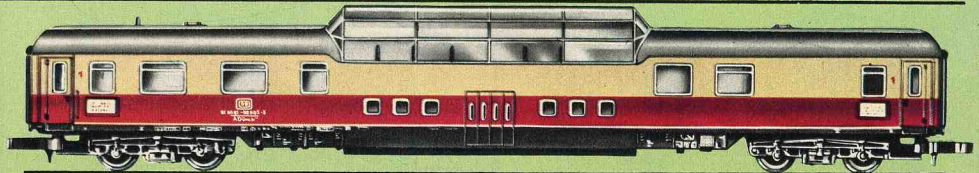

8714 ^{new}

Automobile rack car · A model of the German Federal Railways type DDm 915 · With 8 miniature automobiles aboard · Length 120 mm

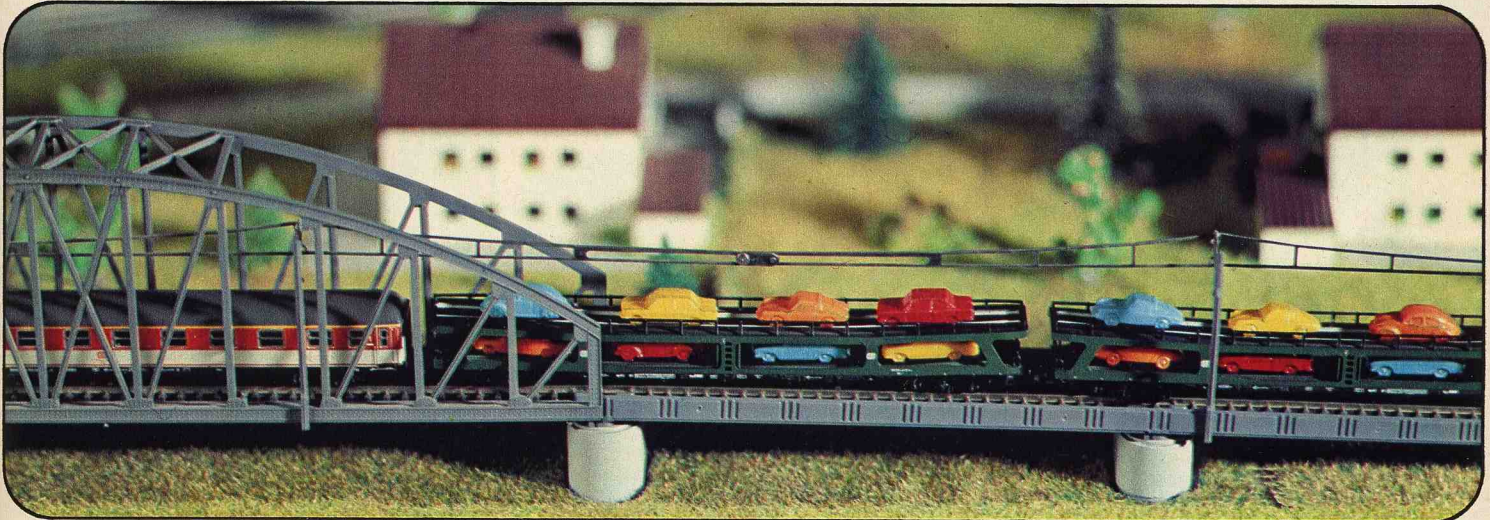
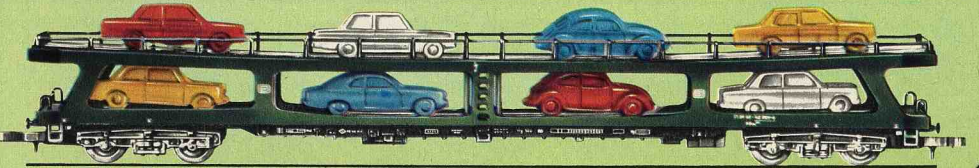

8700

Secondary line passenger coach · Platform and entrance at each end · Windows with "Cellon" panes · Length 60 mm



8701

Secondary line passenger coach · Platform and entrance at each end · Windows with "Cellon" panes · Length 60 mm



The illustrations of cars on pages 72 and 73 are actual size.

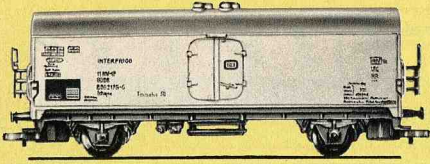

8600

Refrigerator car · A model of the German Federal Railways' type lchqrs · Length 54 mm



8601

Beer car · A model of a car owned by the Dortmunder Union Brewery · Length 54 mm



8602

Beer car · A model of a car owned by the "Spatenbräu" Brewery, Munich · Length 54 mm



8603

Beer car · A model of a car owned by the Kulmbacher Mönchshof Brewery · Length 54 mm

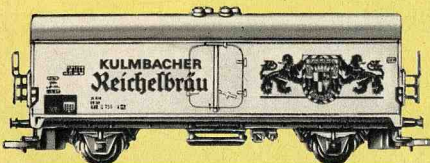

8604

Beer car · A model of a car owned by the Kulmbacher Reichelbräu Brewery · Length 54 mm

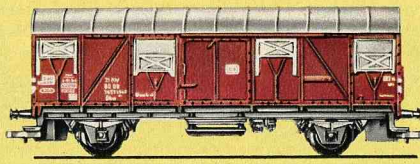

8605

Box car · A model of the German Federal Railways' type Gbrs · Length 54 mm

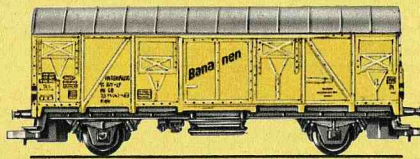

8606

Box car · A model of the German Federal Railways' type lbbbs · Length 54 mm

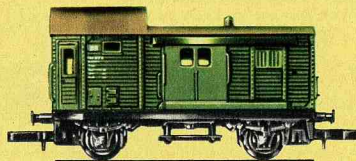

8609

Freight train baggage car · A model of the German Federal Railways' type Dg · Doors on both sides which open · Length 40 mm

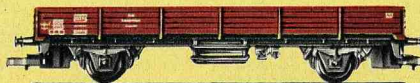

8610

Low-sided car · Length 54 mm



8611

Tank car · SHELL · Length 40 mm

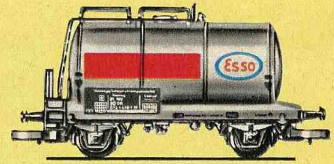

8612

Tank car · ESSO · Length 40 mm



8613

Tank car · ARAL · Length 40 mm

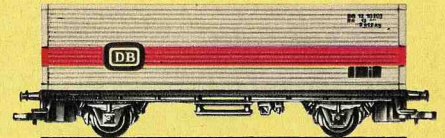

8615

Container car · German Federal Railways · Length 54 mm



8616

Container car · SEALAND · Length 54 mm

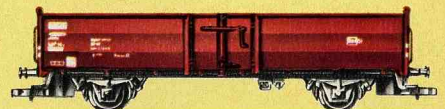

8622

Open freight car · A model of the German Federal Railways' type Omm 52 · Length 54 mm



8619 **new**

Lumber car in 2 parts · Loaded with sawn lumber · Length 93 mm

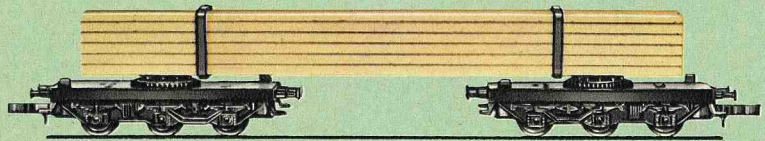

The illustrations of freight cars on pages 74 and 75 are actual size.

8620

Well car · Loaded with transformer · Length 154 mm



8621

Crane car with revolving crane, movable boom and boom support · Crane hook can be raised and lowered by hand crank · Length of underframe 35 mm · (Low-sided car 8610 is not included in the price, but is recommended for use when moving the crane car)

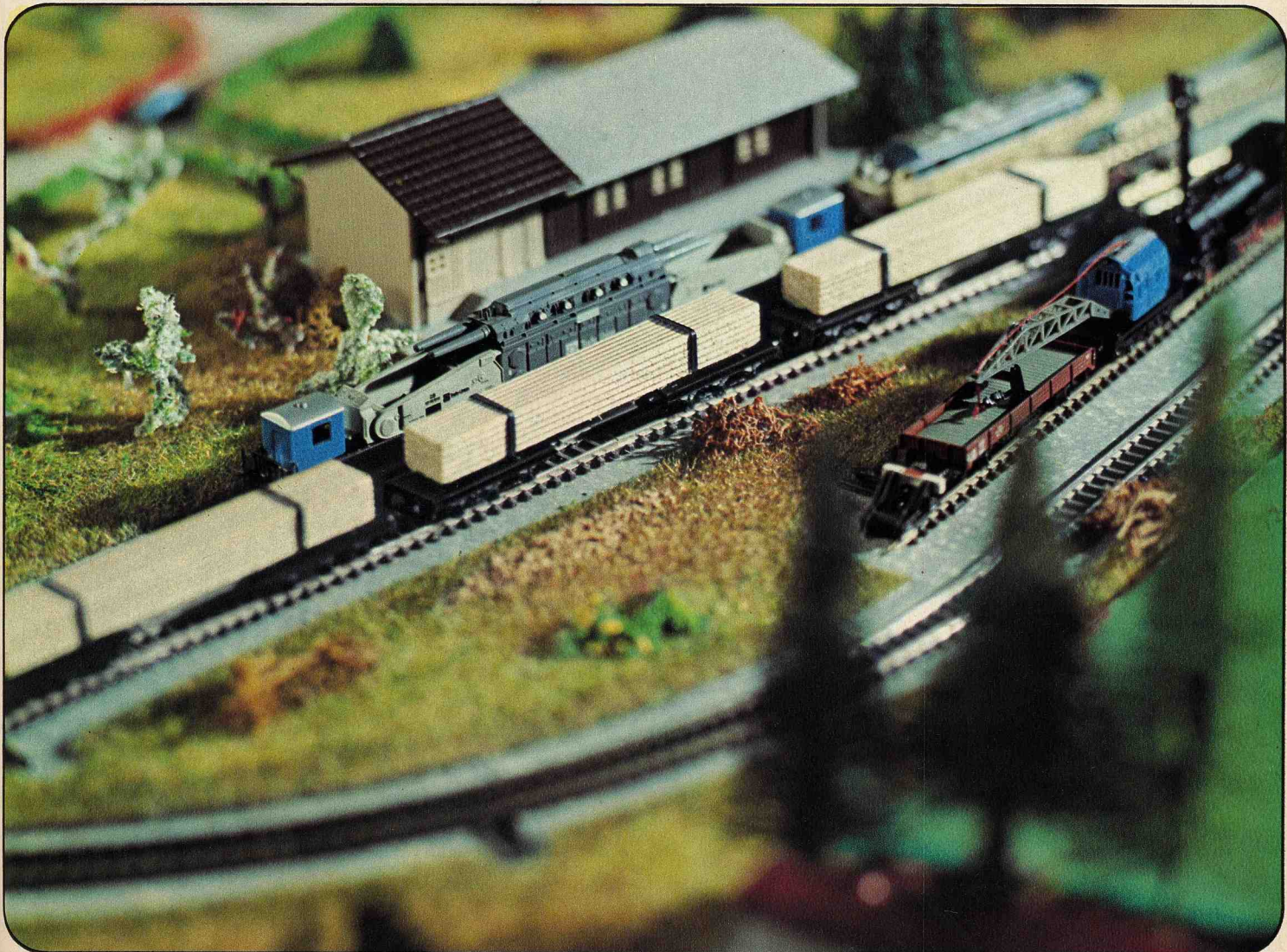
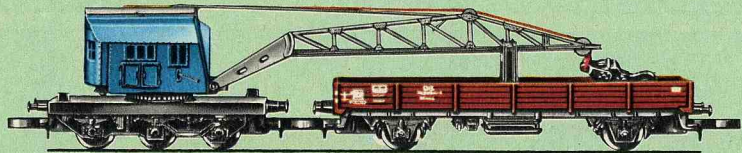

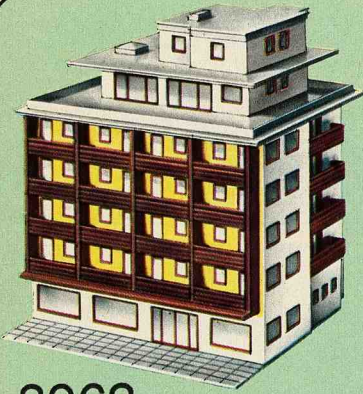

8963

Apartment block building kit with roof penthouse · The two top sections can also be used separately as a bungalow and a kiosk · Base area 86 × 84 mm · Height 97 mm · Can be fitted with light socket 8950

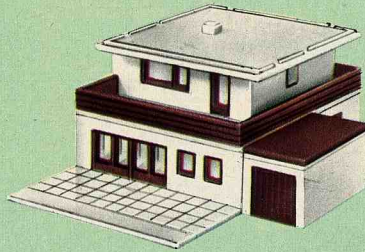

8968

Terrace house building kit, with garage · White · Can be built one or two-storied in a number of different ways, or can be used as a terrace house · Base area 81 × 45 mm · Height 29 mm · Can be fitted with light socket 8950

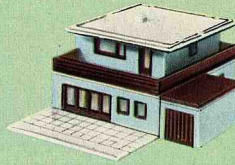

8969

Terrace house building kit, with garage · The same kit as 8968, but with pale blue wall sections

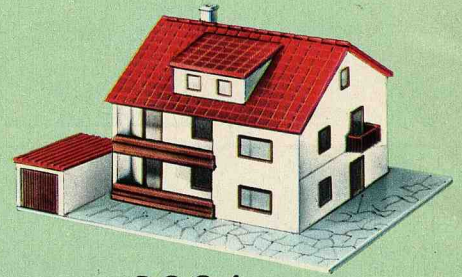

8964

Dwelling house building kit, with garage · Can be used one or two-storied · Base area 91 × 71 mm · Height 45 mm · Can be fitted with lighting socket 8950

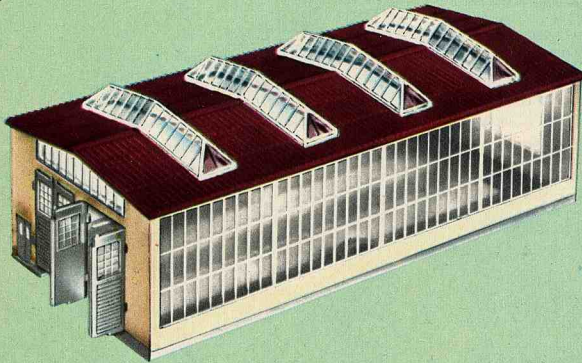

8966

Locomotive shed building kit · Can accommodate two locomotive storage tracks and catenary system · Length 152 mm · Width 74 mm · Height 51 mm



8965

Signal box building kit · Base area 69 × 39 mm · Height 46 mm · Can be fitted with lighting socket 8950



8962

Dürnau station building kit · Multipurpose building with annex and loading ramp · Base area 70 × 50 mm · Height 30 mm · Can be fitted with lighting socket 8950



8970 new

Wintersdorf station building kit with main building, annex and covered passage-way · Base area 72 × 112 mm · Height 54 mm · Can be fitted with lighting socket 8950

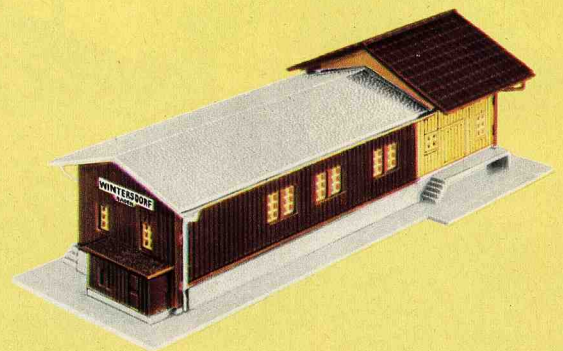

8971 new

Freight shed building kit with freight storage area, loading ramps and equipment storage room · Base area 53 × 130 mm · Height 38 mm · Can be fitted with lighting socket 8950



8960

Göppingen station (center block) building set · Modern design · Base area 228 × 114 mm · Height 44 mm · Can be fitted with lighting socket 8950

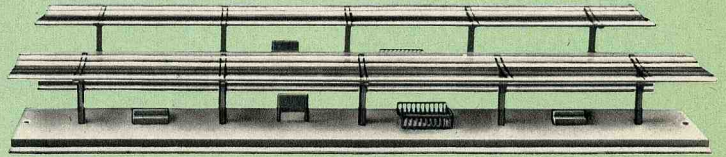

8961

Platform building set · In 2 sections · Total length 440 mm · Width 38 mm · Height 23 mm

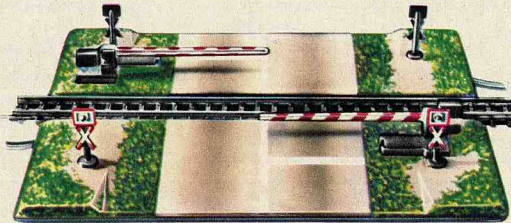
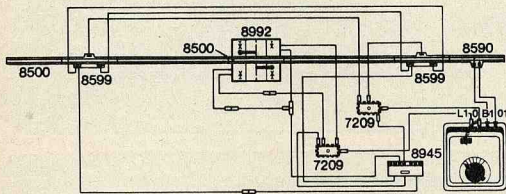

8992

Grade crossing with half barriers · Comprising 2 solenoid-operated barriers, each with 2 red warning lamps which light when the barrier is closed · Size of base 96 × 37 mm · (The track sections shown in the illustration are not included in the price and are not supplied with the grade crossing)

⚡ = 8953

The following items are also required with the grade crossing:

a) for **manual operation**

1 Signal control switch 8946

b) for **automatic** operation by a moving train

1 Universal remote control switch 8945

2 Switching track sections

(of appropriate type, e.g. 8599, 8529 or 8539)

The various ways in which the grade crossing can be installed are fully described in the accompanying instructions for use.

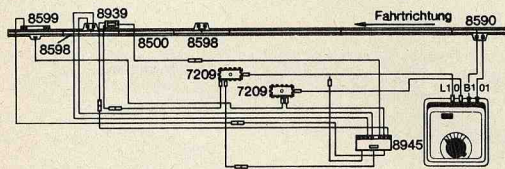

Circuit diagrams showing connection of signal 8939 and connection of switching track section, on "stop" (Hp0).



8939

Color light home signal · Signal lights change from red (Hp0) to green (Hp1) · 2 bulbs · Can be operated by the universal remote control switch 8945 or by signal manual switch 8946 · Height 34.5 mm

⚡ = 8953

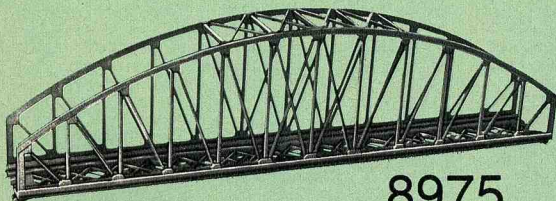

8975

Arch bridge · Made of plastic · Gray · Length 220 mm

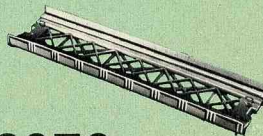

8976

Straight ramp section · Length 110 mm



8977

Curved ramp section · Radius 145 mm · Track curvature 45°

8978

Set of approach ramp columns · Contains one column of each of following heights: 4 mm, 8 mm, 12 mm, 16 mm, 20 mm, 24 mm, 28 mm, 32 mm, 36 mm and 40 mm · Installation instructions are included

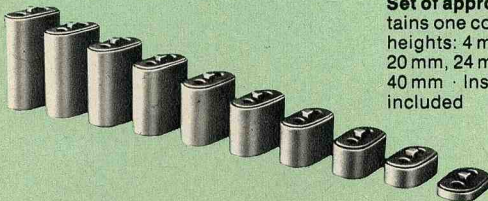

8979

Set of bridge piers · Comprising 5 piers 40 mm high

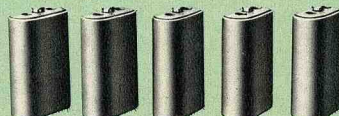

With a gauge of 6.5 mm, the overall width of Märklin mini-club track sections is about 11.5 mm. The height is about 2.5 mm. The accurately dimensioned nickel silver rails are mounted on plastic cross-ties. The track sections are joined to each other by means of rail joint clips, as on larger scale railroads. The rigidity of the track joints is increased by means of an additional claw coupling on the cross-ties.

This diagram shows the 3 Märklin mini-club track circles, with their radii, the distances between them and the curvature of the sections.

- 1 circle 8510 = 8 track sections
- 1 circle 8520 = 8 track sections
- 1 circle 8530 = 8 track sections

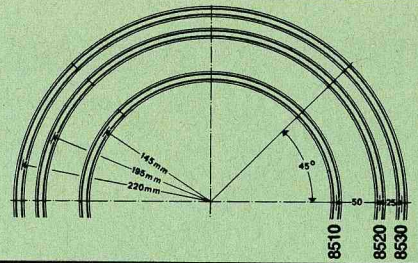

Straight track sections

8500
Length 110 mm



8504
Length 25 mm



8505
Length 220 mm

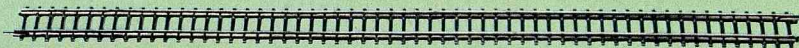

8506
Length 108.6 mm
(see fig. 2, page 79)



8507
Length 112.8 mm
(see fig. 4, page 79)



Curved track sections

8510
Radius 145 mm · 45°

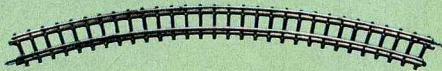

8530
Radius 220 mm · 45°



8520
Radius 195 mm · 45°



8531
Radius 220 mm · 30°



8521
Radius 195 mm · 30°



8591
Radius 490 mm · 13° · Matches the curve of turnouts 8561 and 8564
(see fig. 3, page 79)



Tracks with special uses

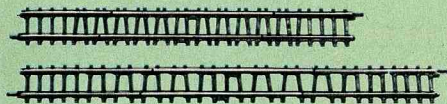

8592
Straight track sections · For adjusting to required length · Can be extended from 100 to 120 mm



8598
Isolating track section, straight · With connector terminals · The rail nearer the terminals has a gap half way along it · Length 110 mm



8529
Switching track section, curved · With connector terminals · To enable moving trains to trigger switching functions · Radius 195 mm · 30°



8590
Straight feeder track section · With capacitor for radio interference suppression · 2 terminals for connection of the traction current leads supplied · Length 110 mm



8599
Switching track section, straight · With connector terminals · To enable moving trains to trigger switching functions · Length 110 mm

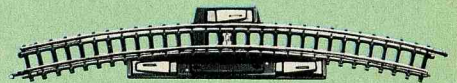

8539
Switching track section, curved · Construction and operation as for 8529, but with radius 220 mm · 30°



8597
Uncoupling track section · For releasing automatic coupling · Uncoupling ramp is either solenoid-operated or hand lever operated · Length 110 mm

The switching track sections 8529, 8539 and 8599 enable a moving train to control solenoid-operated items automatically. They are actuated by the locomotive, and can trigger different and independent switching functions in each direction. The control pulses are fed out via two terminals insulated from each other.

Crossing and turnouts

8559

Crossing · Crossing angle 13° · Length of track sections 112.8 mm · (See fig. 1)



1

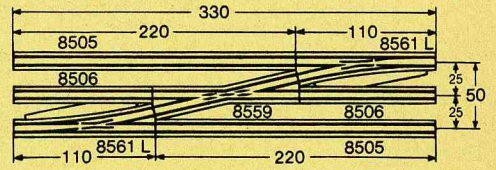

8560

Double slip · Crossing angle 13° · Radius 323 mm · The slip points, which are on the inside, are double solenoid-operated by remote control · Additional hand control lever · Length of straight track sections 112.8 mm · (See fig. 2 for an example of its installation).

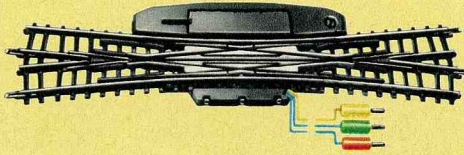

2

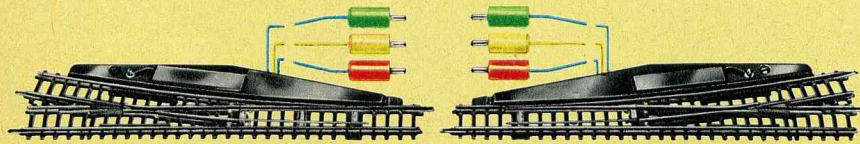
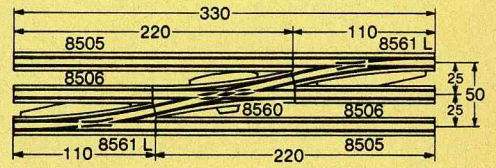

8561

Pair of solenoid-operated turnouts · Consisting of one right and one left-hand turnout, each operated by double solenoid · Additional hand control lever · Turnout angle 13° · Radius of branch track 490 mm · Length of through track section 110 mm · (See figs. 3 and 4 for examples of turnout installation)

noid · Additional hand control lever · Turnout angle 13° · Radius of branch track 490 mm · Length of through track section 110 mm · (See figs. 3 and 4 for examples of turnout installation)

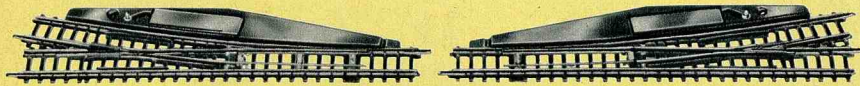

3

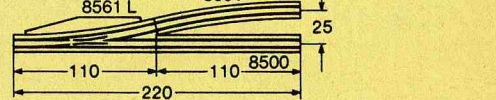

8564

Pair of manually-operated turnouts · Consisting of one right-hand and one left-hand turnout · Operated by hand lever · Turnout angle 13° · Radius of branch track 490 mm · Length of straight track section 110 mm · (See figs. 3 and 4 for examples of its installation)

Turnout angle 13° · Radius of branch track 490 mm · Length of straight track section 110 mm · (See figs. 3 and 4 for examples of its installation)

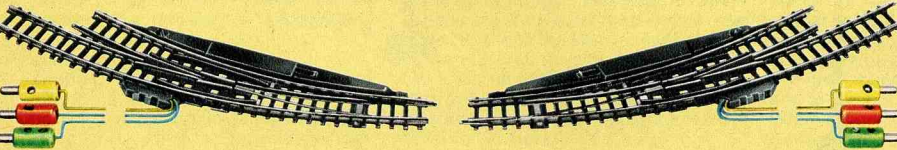

4

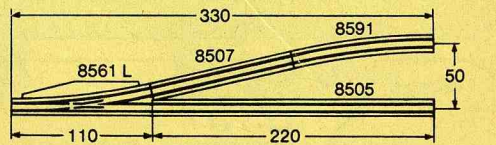

8567

Pair of solenoid-operated curved turnouts · Consisting of one right-hand and one left-hand inner circle turnout · Each operated by double solenoid · Length and radius of branch track the same as for track section 8521 · Length of through track 125 mm · (See fig. 5 for an example of its installation)

operated by double solenoid · Length and radius of branch track the same as for track section 8521 · Length of through track 125 mm · (See fig. 5 for an example of its installation)

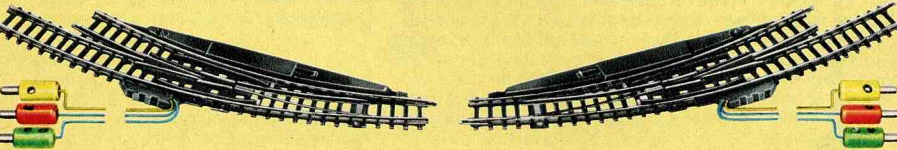

5

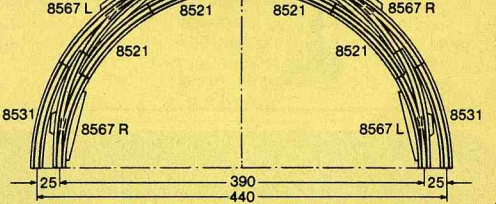

Track accessories

8951

Pack of 10 insulating links · Made of plastic · For electrically isolating lengths of track

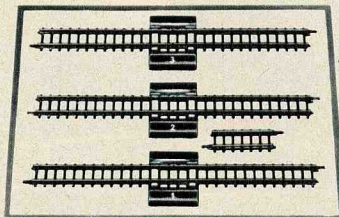

8991

Bumper · For clipping onto the rails · Black · Buffer beam white with red stripe · Length 15 mm



8993

Reversing loop kit · Consisting of 3 track sections, each 110 mm long, which are arranged in the sequence of their identifying numbers, and 1 track section 8504 · Allows one-way travel on reversing loops

8999

Track fixing nails · 0.5 × 6 mm · Pack of 100

0208

Track plan template for Märklin mini-club tracks · All track sections are marked out in 1:5 scale on the template, from which they can easily be transferred onto paper with a pencil

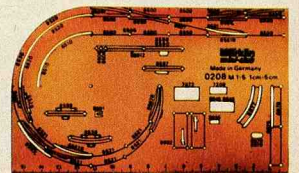

0292

Booklet entitled "Märklin mini-club track layouts" · Illustrated guide for the building of 16 track layouts and catenary systems, connecting up power packs and solenoid-operated items and for building bridges · Contents 54 pages · Size 21 × 30 cm · English text



Catenary system Lighting

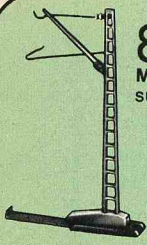

8911

Mast for overhead line · Basic unit with supporting plate · Height 38 mm



8912

Feeder mast for power supply · With supporting plate and connector lead · Height 38 mm



8913

Bridge mast for clipping onto the side of bridges and ramp sections · Height 41 mm



8914

Tower mast with recesses for hooking in cross spans 8924 and 8925 · Base 7 × 13 mm · Height 61 mm



8923

Contact line section · Length adjustable between 150 and 180 mm

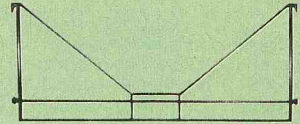

8925

Cross span · For hooking into tower masts · Spans 3 tracks · Span approx. 72 mm

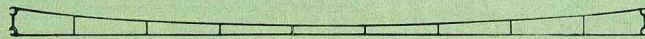

8922

Contact line section for straight and curved tracks · Length 165 mm

8924

Cross span · For hooking into tower masts · Spans 5 tracks · Span approx. 123 mm

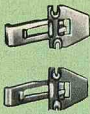
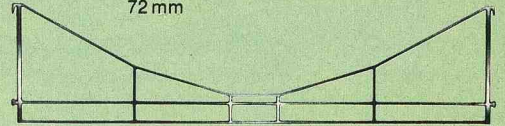

8921

Pack of contact line insulators · For insulating contact line sections from cross spans · Includes white and gray insulators · The white insulators will hold 2 contact line sections, the gray ones 3

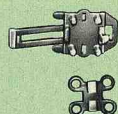

8926

Pack of isolating sections and connection springs · Are required for making isolating points in the overhead line, and at branches above turnouts

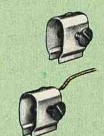

8927

Pack of contact wire terminals · Contains screw terminals with and without leads · For feeding power into catenary sections or for holding sections of the contact line together, above crossings, for example

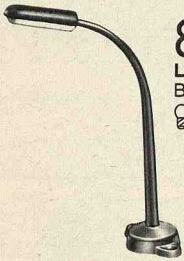

8957

Lamp standard · Height 46 mm · Base 8 × 14 mm
⚪ = 60210

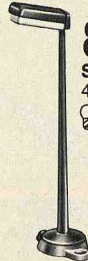

8958

Station lamp standard · Height 46 mm · Base 8 × 14 mm
⚪ = 60210



8959

Sidewalk lamp standard · Height 25 mm · Base 8 × 14 mm
⚪ = 60210



Accessories Power packs



8973

Pack containing various miniature automobiles



8974

Re-railing ramp · Made of plastic · Makes it easier to set locomotives or cars on the track · Length 140 mm · Height 13.5 mm

8987

Pair of carbon brushes for locomotives 8800, 8803, 8864 and 8895

8988

Pair of carbon brushes for locomotives 8816, 8854, 8857, 8858, 8874 and 8875

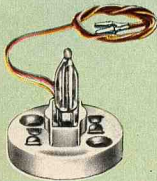

8950

Light fitting with lamp insert and lead
For stations, buildings etc.

Ⓛ = 8953



8953

Lamp insert · With 10 V · For use in light fitting 8950, signal 8939, grade crossing 8992 and in locomotives which can take lighting

8989

Pair of carbon brushes for locomotives 8827 and 8885

60210

Light bulb for items 8957, 8958 and 8959

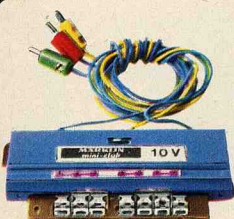

8945

Universal remote control switch with 2 single-pole switches and one changeover switch for various circuits · The universal remote-control switch can be given a variety of functions to perform (up to 3 simultaneously) and it will perform them automatically · It can control grade crossings, for

example, and lighting installations, and many other things · Examples of applications are shown in booklet 0292 (see page 79) and in the Märklin mini-club guide · Operating voltage 10 V · Double-solenoid operation · Can be operated by a switching track section, a turnout control box or by means of the hand control lever · Width 30 mm · Length 70 mm · Height 8 mm



8946

Signal control panel with 2 single-pole switches and one changeover switch, which can be used, for example, to control the sequence of lights in signal 8939 and to control the traction current · Width 30 mm · Length 70 mm · Height 8 mm

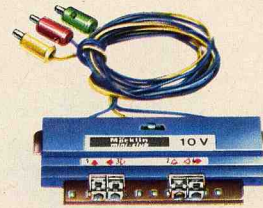

8947

Double-pole changeover switch (polarity reversing switch) · Operating voltage 10 V · Double-solenoid operation · Can be operated by a switching track section, a turnout control box or by means of the hand control lever · Width 30 mm · Length 70 mm · Height 8 mm

6711

220 Volt

Märklin mini-club power pack for use with AC power supply · Single knob control for adjusting the traction voltage (DC) between 0 and 8 V and for determining the direction of travel by turning clockwise or anticlockwise from its central position · Power output in the traction circuit up to 8 VA, and in the lighting circuit (AC) about 12 VA at 10 V · Blue plastic case · Weight 1.65 kg · Dimensions 155 × 110 × 88 mm

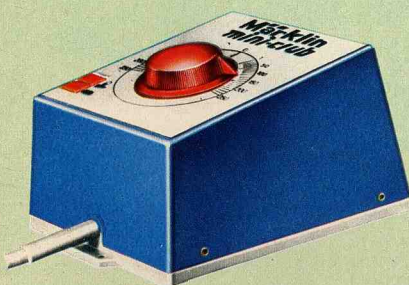

6720

100 Volt Japan

6726

110 Volt

6727

110 Volt USA

6729

240 Volt England

6731

220 Volt

Märklin mini-club power pack for use with AC power supply · Output 12 VA · Traction voltage (DC) adjustable between 2 V and 8 V · Polarity reversing switch for selecting the direction of travel · Lighting voltage (AC) 10 V · Blue plastic case · Weight 1.2 kg · Dimensions 125 × 135 × 75 mm

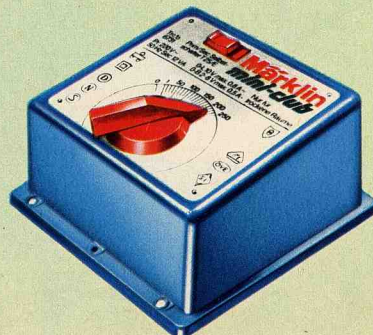

Train sets

5500

Freight train (without transformer) · With tank locomotive 5700, 1 open freight car 5850, 1 dump car 5859, 2 straight track sections 5900, 12 current track sections 5921 and 1 connector kit 5604 · Length of train 97 cm

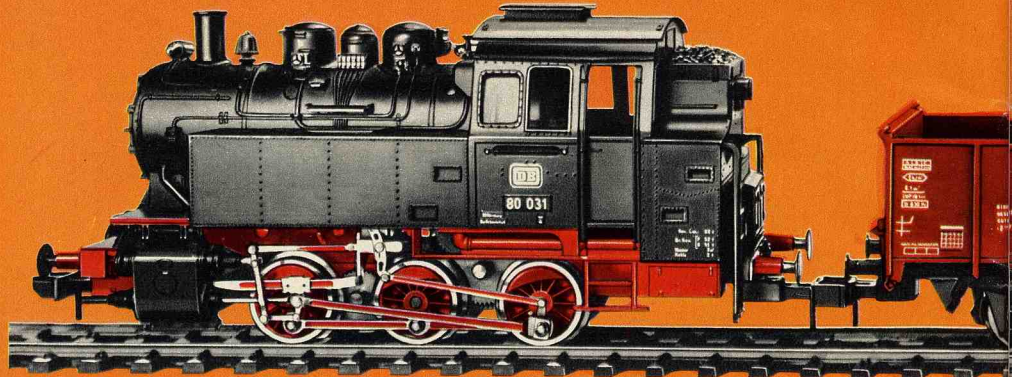

5520

Freight train (without transformer) · With diesel locomotive 5720, 1 open freight car 5850, 1 dump car 5859, 2 straight track sections 5900, 12 curved track sections 5921 and 1 connector kit 5604 · Length of train 97 cm



Tank locomotive

5702

Tank locomotive · Wheel arrangement 0-6-0 · 2 non-skid tires · Simulated Heusinger reversing gear · Remote control for forward and reverse drive · 3 working headlights at each end · Plastic body, black boiler, dark green water tanks and cab, brass-colored window frames and hand rails · Cab doors will open · Windows have "cellon" panes · Die cast zinc frame · Automatic claw coupling and sprung buffers at each end · Length over buffers 30.25 cm

⊙ = 60015

60041

Pair of carbon brushes for I-gauge locomotives

Märklin transformer 6631 is suitable for operating I-gauge locomotives.



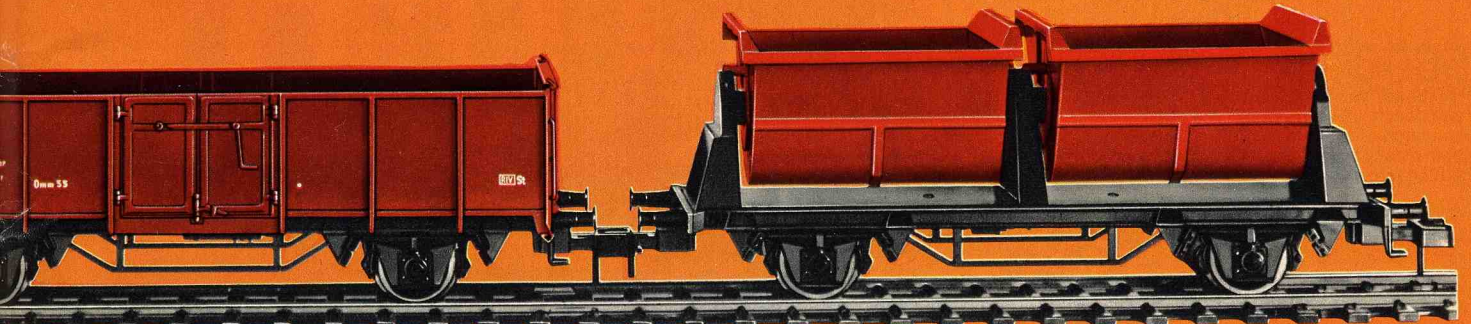

Tank locomotive

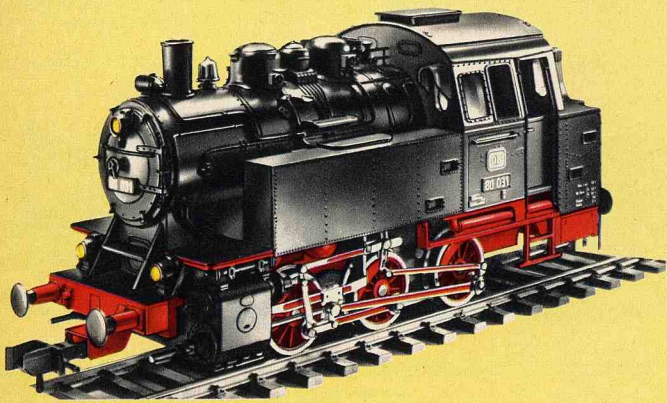

5700

Tank locomotive · A model of the German Federal Railways' 0-6-0 class 80 locomotive · 2 non-skid tires · Simulated Heusinger reversing gear · Remote control for forward and reverse drive · 3 working

headlights at each end · Mat black plastic body · Cab doors will open · Windows have "Cellon" panes · Die cast zinc frame · Automatic claw coupling and spring buffers at each end · Length over buffer 30.25 cm

Q = 60015

Diesel locomotive



5720

Diesel locomotive · A model of a 0-6-0 industrial locomotive · 2 non-skid tires · Remote control for forward and reverse drive · 3 working headlights at each end · Red plastic body with two yellow horizontal

stripes · Cab doors will open · Windows have "Cellon" panes · Die cast zinc frame · Automatic claw coupling and spring buffers at each end · Length over buffers 30.25 cm

Q = 60015

Passenger cars with interior fittings

5800

Passenger car · Modeled on a private rail-road coach · 2 doors which will open · Simulated ventilators on roof · Windows inset in plastic frames · Interior fittings representing wooden seats · Length 31 cm

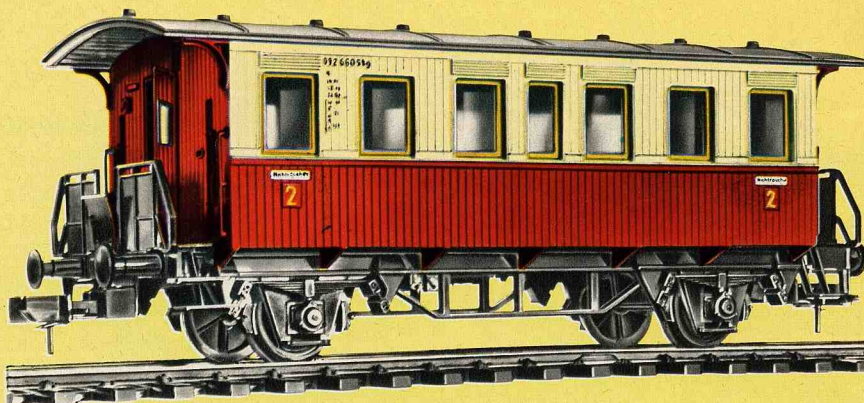

5801

Passenger car · Modeled on an original of the former Royal Württemberg Railway · Similar in design to 5800, except that it is green



Freight cars

5850

Open freight car · A model of the German Federal Railways' type Omm 55 · Length 31 cm



5856

Open freight car · Light green car body · Black frame · Length 31 cm

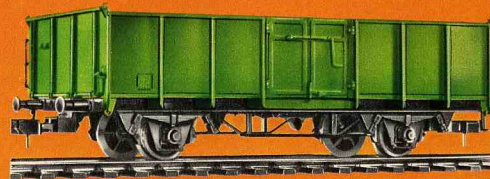

5851

Open freight car · A model of a Belgian State Railways (SNCB) freight car · Length 31 cm

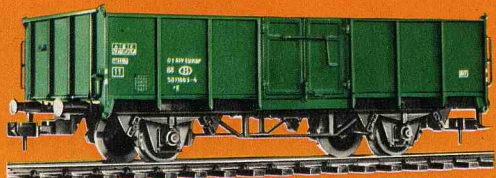

5859

Dump car · 2 independent hoppers dump to either side · Latch holds hoppers in upright position · Length 31 cm

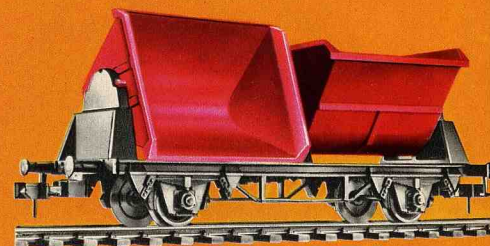

5853

Flat car · With removable stanchions · Length 31 cm

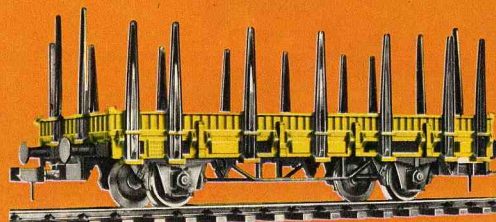

5860

Box car · A model of the German Federal Railways' type G1s · Doors on each side which will open · Length 31 cm



Track sections

The rails, mounted on plastic ties and insulated from one another, not only guide the wheels but also act as conductors for current supply and return. Track sections are joined together by rail jointing clips and also by a clip on the tie strip. The solid rails are stainless and corrosion-resistant so you can even lay them in your yard. Outer diameter of a track circle is 1.28 m.



5900
Straight track section · Length 300 mm



5908
Straight track section · Length 80.4 mm



5909
Isolating track section, straight · For dividing the layout into electrically isolated sections · Length 80.4 mm



5921
Curved track section · Radius 600 mm · Curve 30°

5962



Solenoid-operated left-hand turnout · Operated by double solenoid · Sprung switch points · Turnout angle 30° · Radius of branch track 600 mm · Length of straight track section 300 mm

5963



Solenoid-operated right-hand turnout · Operated by double solenoid · Sprung switch points · Turnout angle 30° · Radius of branch track 600 mm · Length of straight track section 300 mm

5965



Manually-operated left-hand turnout · Sprung switch points · Turnout angle 30° · Radius of branch track 600 mm · Length of straight track section 300 mm

5966



Manually-operated right-hand turnout · Sprung switch points · Turnout angle 30° · Radius of branch track 600 mm · Length of straight track section 300 mm

5600

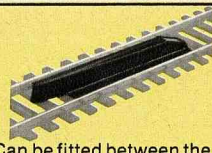

Uncoupler · Can be fitted between the rails of track section 5900 · Releases couplings, in one direction of travel only, thus enabling cars to be pushed away · Length 175 mm

5603



Retaining clips · Bag of 28 · For securing the joints between I-gauge track sections

5604

Connector kit · Consisting of 2 connector terminals, with one red and one brown lead · 1 meter long · Incorporates a capacitor for radio interference suppression

Although a two-rail conductor system is used, a polarity problem does not arise even when you construct reversing loops, diagonals or Y-tracks. This is because Märklin large scale railroads are equipped with AC motors, sharing this advantage with the HO-gauge system. As with the HO-gauge, the direction of travel is switched by the "engineer" built in to the locomotive.

5861

Beer car · A model of a car owned by the Dortmunder Union Brewery · Doors on each side which will open · Length 31 cm



5863

Beer car · A model of a car owned by the Haller Löwenbräu Brewery · Doors on each side which will open · Length 31 cm



5862

Beer car "Staufenbräu" · Doors on each side which will open · Length 31 cm



5864

Beer car · A model of a car owned by the Kulmbacher Mönchshof Brewery · Doors on each side which will open · Length 31 cm



5602

Bumper, riveted steel type · Sprung buffers · Clips onto the rails · Length 98 mm

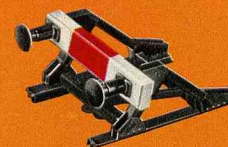



Race track sets 1:32

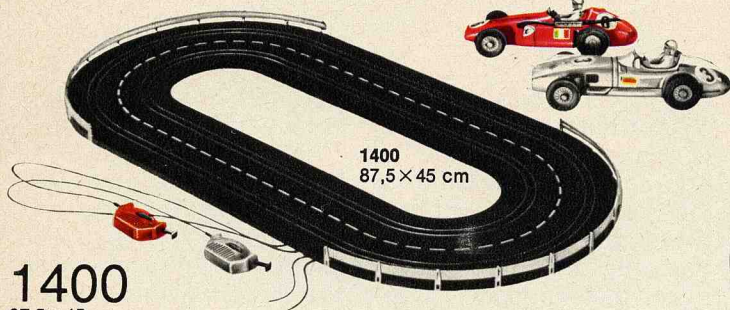

1400
87,5 × 45 cm

1400
87,5 × 45 cm

Race track set · Contains two formula racing automobiles (one Mercedes Monoposto and one Ferrari Supersqualo), one red and one gray speed controller,

4 straight course sections 1200 and 4 curved course sections 1220, crash barriers and 20 crash barrier supports · These parts will make up an oval circuit · Full instructions are included

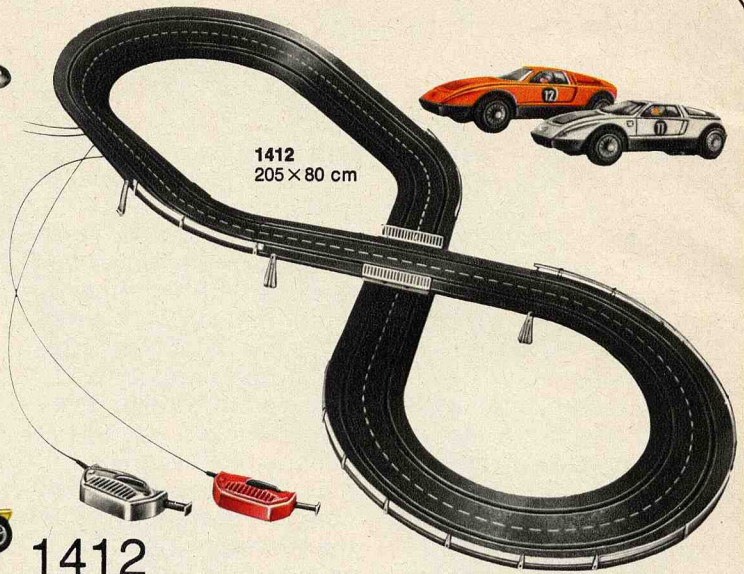

1412
205 × 80 cm

1412
205 × 80 cm

Race track set with 1 banked curve · Contains 2 Mercedes C 111 sports cars, 1 red and 1 gray speed controller, 2 straight course sections 1205, 4 straight course sections 1206, 8 curved course sections 1241, 4 banked curve sections 1248, crash

barriers, 22 crash barrier supports, 2 bridge parapets, 1 jointing section 1547 and 5 banked curve supports · These parts will make up a figure-eight course with overpass and 1 banked curve · Full instructions are included

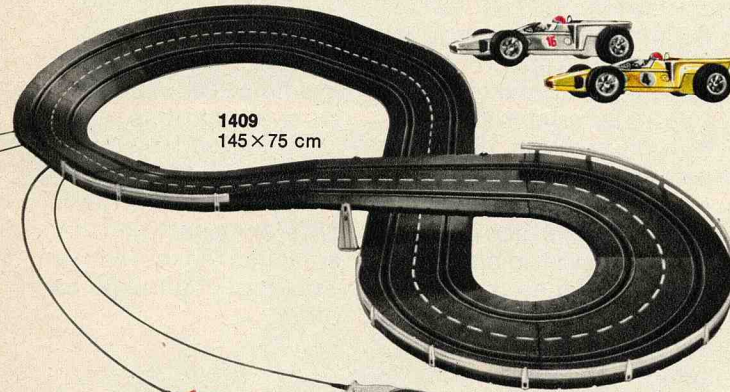

1409
145 × 75 cm

1409
145 × 75 cm

Race track set with 1 banked curve · Contains 2 McNamara racing automobiles, 1 red and 1 gray speed controller, 2 straight course sections 1200, 2 straight course sections 1201, 2 straight course sections 1206, 3 curved course sections 1220, 2 curved course sections 1241, 4 banked curve sections 1248, crash barriers, 19 crash barrier supports, 3 banked curve supports and one jointing section 1547 · These parts will make up a figure-eight course with overpass and 1 banked curve · Full instructions are included

1405
245 × 100 cm

Race track set with 1 banked curve · Contains 1 white and 1 orange-colored Mercedes C 111, 1 red and 1 gray speed controller, 2 straight course sections 1200, 4 straight course sections 1201, 2 straight course sections

1205, 8 curved course sections 1241, 4 banked curve sections 1248, 2 leveling-out course sections for start of incline 1290, 2 leveling-out course sections for end of incline 1291, crash barriers, 30 crash barrier supports, 4 jointing sections 1547 and 2 clips · These parts will make up a figure-eight course with overpass and 1 banked curve · Full instructions are included

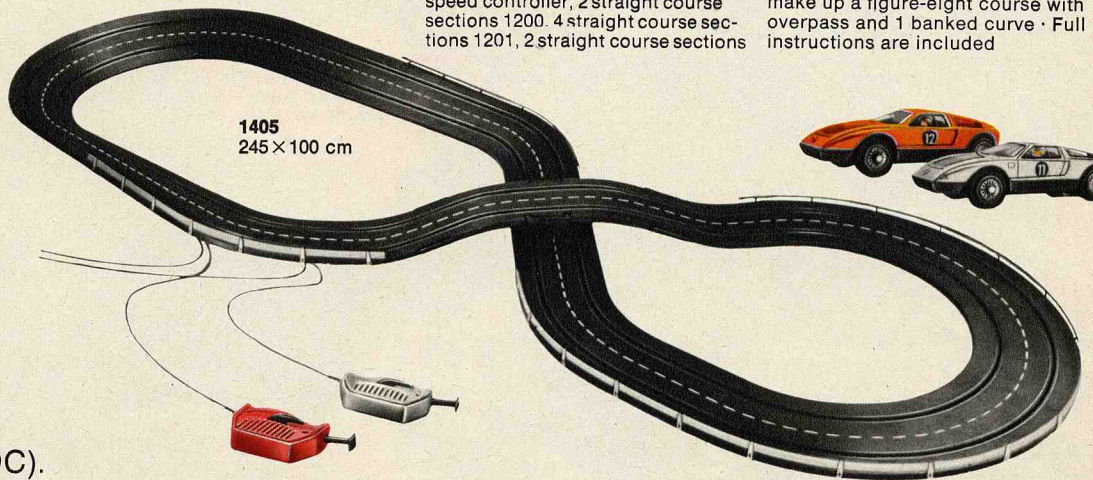

1405
245 × 100 cm

Caution!
Märklin-Sprint automobiles must be supplied only with **DIRECT CURRENT (DC)**.

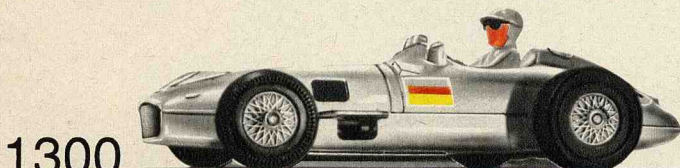

1300

Formula racing automobile · A model of the Mercedes W 196 Monoposto · Driven through multiratio gearbox · Silver-colored plastic body · Length 12.8 cm · Spare tires for this automobile: front 1500, rear 1501 or 1504



1301

Formula racing automobile · A model of the Ferrari Supersqualo · Driven through multiratio gearbox · Red plastic body · Length 12.5 cm · Spare tires for this automobile: front 1500, rear 1501 or 1504

The front wheels are steered by slots in the course. Accurate reproduction of the suspension arm assembly. Current pick up by 2 sprung skids.

1305

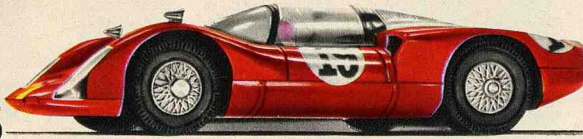

Sports car · A model of the Porsche Carrera 6 · Driven through multiratio gearbox · Red plastic body · Cockpit enclosed by transparent plastic canopy · Length 13 cm · Spare tires for this automobile: front 1500, rear 1503

1308



Sports car · A model of the E-type Jaguar · Swing front axle · Driven through spur gears · Red plastic body · Inset windows · Length 13.4 cm · Spare tires for this automobile: front 1500, rear 1503

1310



Sports car · A model of the Porsche 911 T Targa · Swing front axle · Driven through spur gears · Orange-colored plastic body · Inset windows · Length 12.9 cm · Spare tires for this automobile: front 1500, rear 1503

1311

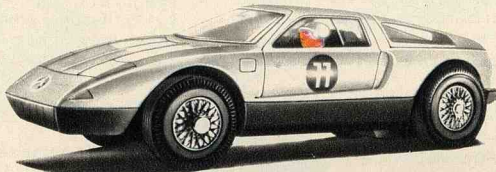

Sports car · A model of the Mercedes C 111 · Swing front axle · Driven through spur gears · White body · Black chassis · Inset windows · Length 12 cm · Spare tires for this automobile: front 1500, rear 1503

1312



Sports car · Same design as 1311, except with orange-colored body

1315



Sports car · A model of the Chaparral 2 E with stabilizer fin · Driven through spur gears · White plastic body · Length 11.6 cm · Spare tires for this automobile: front 1500, rear 1503

⚡ = 60000

1316

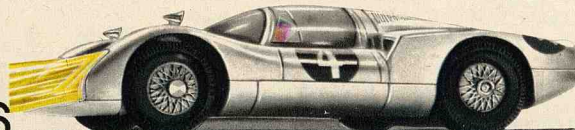

Sports car · A model of the Porsche Carrera 6 · Driven through multiratio gearbox · Silver-colored plastic body · 2 working headlights · Cockpit covered with transparent plastic canopy · Length 13 cm · Spare tires for this automobile: front 1500, rear 1503

⚡ = 60000

1317



Sports car · Same design as 1316, but with open cockpit with windshield · Red plastic body · Length 13 cm

⚡ = 60209

1318

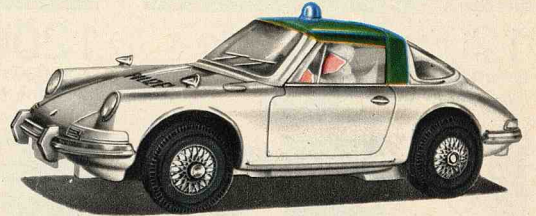

Sports car · Porsche 911 T Targa as police car · **Continuously operating flashing blue light** · Swing front axle · Driven through spur gears · Green and white plastic body · Inset windows · Length 12.9 cm · Spare tires for this automobile: front 1500, rear 1503

1319



Racing automobile · A model of the McNamara · Driven through spur gears · Yellow plastic body · Length 12.3 cm · Spare tires for this automobile: 1505

1320



Racing automobile · A model of the Lola T 222 · Driven through spur gears · Plastic body · Length 12.7 cm · Spare tires for this automobile: 1505

1321

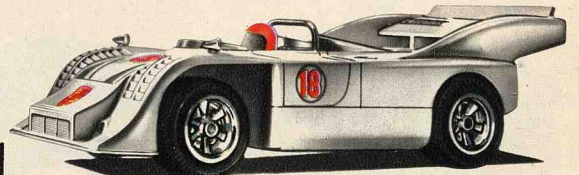

Sports car · A model of the Porsche Can Am 917/10 · Driven through spur gears · White plastic body · Open cockpit with windshield · Length 13.4 cm · Spare tires for this automobile: 1505

1322



Sports car · A model of the BMW 2002 turbo · Driven through spur gears · Plastic body · Length 12.6 cm · Spare tires for this automobile 1505

1323



Sports car · Same design as 1322, but in other colors

Straight course sections

Double lane · 1200, 1201, 1205 and 1206 can be used for power supply connection

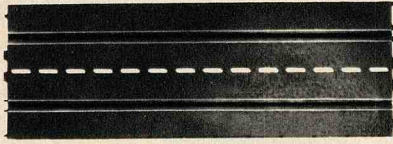

1205
Length 424.2 mm
(twice the length of 1200)

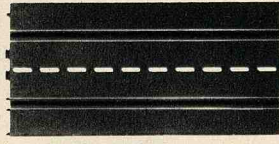

1206
Length 300 mm
(twice the length of 1201)

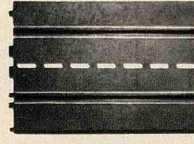

1200
Length 212.1 mm

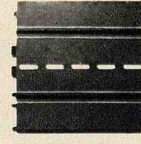

1201
Length 150 mm

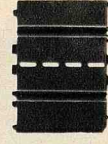

1202
Length 106 mm



1203
Length 62.1 mm



1204
Length 44 mm

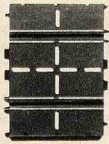

1207

Controlled zone kit · Consists of two course sections each 106 mm long · For use at approach to bottlenecks or lane crossovers · The first vehicle into the

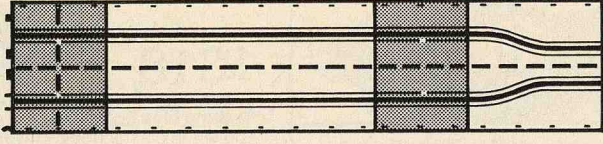

1207

1207

controlled zone automatically cuts off the current in the other lane, and only switches it on again as it leaves the zone

All course sections are made of rigid plastic and have inset channels for steering the automobiles. Current is supplied to the vehicles by contact rails on each side of the steering channels. The locking hinge couplings are all that is required to ensure an absolutely positive joint between course sections. The sections are black with a broken white line in the center.

Straight bottleneck

1216

Straight bottleneck · Double lane · Track separation reduces from 75 to 38 mm · Length 150 mm · **Two of these course sections are required**

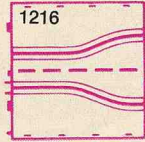
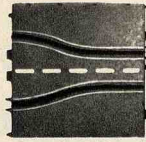

1216

Straight lane cross-over

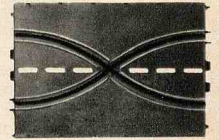

1217

Length 212.1 mm · Double lane · The current feeders are isolated electrically where they cross over

Crossover sections (1217, 1227) cannot be used singly. They are used either in pairs or in combinations with each other.

Curved lane crossover

The current feeders are isolated electrically where they cross over.



1227

90° curved course section with lane crossover · Double lane · Mean radius 150 mm

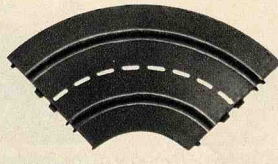

1220

90° curved course section · Double lane · Mean radius 150 mm

Curved course sections

1220, 1241 and 1261 can be used for power supply connection

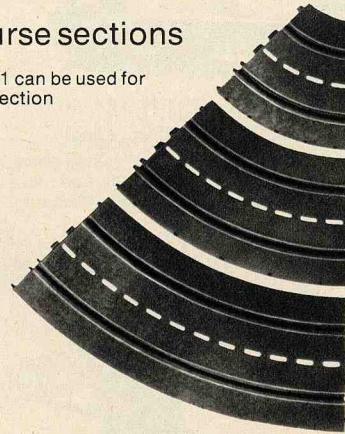

1221

45° curved course section · Double lane · Mean radius 150 mm

1241

45° curved course section · Double lane · Mean radius 300 mm

1261

45° curved course section · Double lane · Mean radius 450 mm

45° banked curve course sections

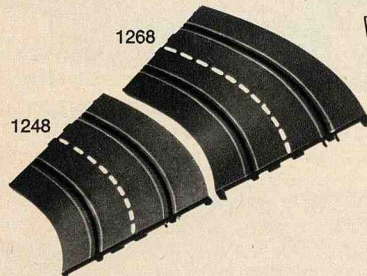

1248

45° banked curve course section · Double lane · Mean radius 300 mm

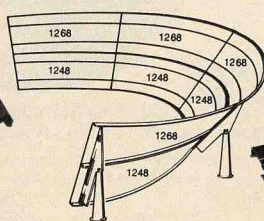

1268

45° banked curve course section · Double lane · Mean radius 450 mm

Inclines

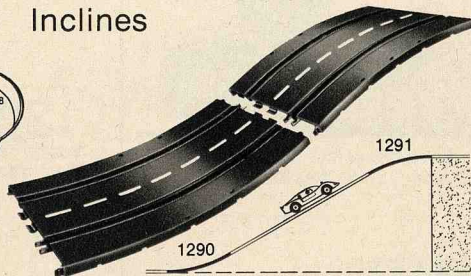

1290

Straight course section for start of incline · Double lane · Concave form · Angle of incline about 30° · Length 220 mm

1291

Straight course section for end of incline · Similar to 1290 but convex · Also includes a clip to make the section rigid

1546

Set of banked curve supports · Consisting of 7 cross supports, 3 posts 128 mm high, 4 posts 78 mm high and 12 jointing sections · Made of plastic · Used with 4-lane banked curves

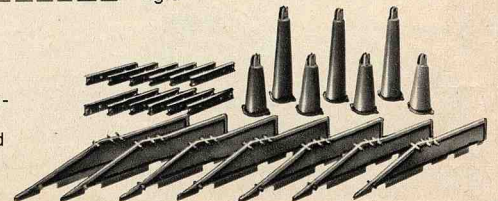

Caution!
Märklin-Sprint automobiles must only be operated with **DIRECT CURRENT (DC)**.



1592

Rectifiers · For connecting to Märklin railroad transformers · Dimensions 57 × 52 × 15 mm · DC supply for operating up to 4 automobiles simultaneously can be taken from the two pairs of sockets marked "Auto 1" and "Auto 2" · The transformer used must be rated at 16 VA or more



1593

Starting clock · To be connected between the power pack and the race track layout · When the time set on the knob (adjustable between 0 and 5 minutes) has elapsed, the current supply to the track is cut off · Pressing the red "start" button gives clearance to start

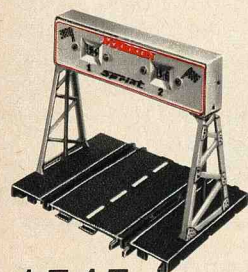

1545

Mechanical lap counter · Mounted on a 106 mm double lane course section · Displays up to 99 laps for each lane in either direction · Indicators zeroed by hand · Height 130 mm · Width 150 mm · **A section 1202 is required as a make-up length** · On multi-lane courses several lap counters can be placed in a continuous line across the course



6771

Märklin-Sprint power pack for connecting to 220 V AC mains supply · Output approx. 14 V DC · Power output 10 watts · Overload protection by automatic current limiter · Plastic case · Weight 1.2 kg · Dimensions 125 × 135 × 55 mm

The use of power pack 6771 is recommended. If Märklin railroad transformers are used it is essential to connect the rectifier 1592 between the transformer and the speed controller.



1591

Speed controller with connection kit · Red · Shaped for easy handling · The control key is notched to enable various speeds to be set · The emergency stop button enables the current to be cut off without disturbing the setting of the speed control key · Built-in capacitor for radio interference suppression · The connection kit consists of a connector plate, which is connected to the speed controller by a 1.5 m long two-core lead, and a 1 m long two-core lead with a plug for connecting to the power pack · A speed controller must only be used to control one automobile at a time



1594

Speed controller with connection kit · Large version · 40 ohms · Electrodynamic braking operates when press key is not being pressed · Built-in capacitor for radio interference suppression · Connection kit consists of a connector plate, which is connected to the speed controller by a 3-core lead, and a two-core lead with plugs for connecting to the power pack · A speed controller must only be used to control one automobile at a time



1540

Crash barrier · Corrugated type, made of flexible plastic · White · 2 m long

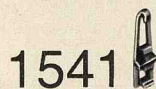

1541

Crash barrier support · Made of white plastic · For fixing crash barriers to the course

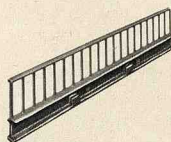

1544

Bridge parapet · For adding rigidity to overpasses · Made of gray plastic · 135 mm long · 38 mm high

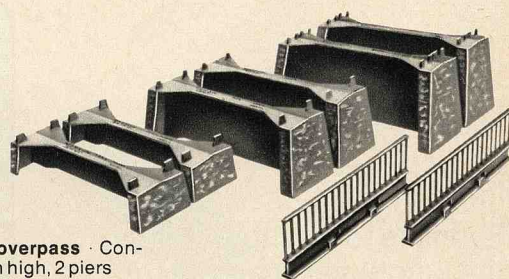

1542

Construction kit for overpass · Consists of 2 piers 27 mm high, 2 piers 49 mm high, 2 piers 61.5 mm high and 2 bridge parapets · All parts are made of gray plastic · Enables a very solid overpass to be built, which can span even multi-lane courses



1547

Jointing section · 74 mm long · Made of black plastic · For connecting adjoining straight course sections and stiffening the joints

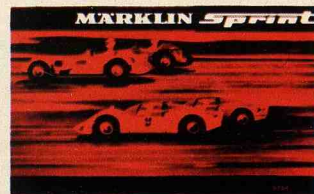

0751

"Märklin-Sprint race track" manual with ideas for designing race tracks · Includes racing rules and interesting illustrations · Contents 44 pages · Size 18 × 28 cm · English text

Tire sets

1500

Contains 2 rubber tires 20.5 mm (diameter) × 6 mm · For models 1300, 1301, 1305, 1308, 1310, 1311, 1312, 1315, 1316, 1317, 1318

1501

Contains 2 rubber tires 23 mm (diameter) × 7 mm · For models 1300, 1301

1503

Contains 2 rubber tires 20.5 mm (diameter) × 7.6 mm · For models 1305, 1308, 1310, 1311, 1312, 1315, 1316, 1317, 1318

1504

Contains 2 rubber tires 24 mm (diameter) × 8.4 mm · For models 1300, 1301

1505

Contains 2 rubber tires 20.5 mm (diameter) × 8.5 mm · For models 1319, 1320, 1321, 1322, 1323

Current pickups adapters

1510

(1 pair) · For clipping onto the pickup skids of Märklin-Sprint automobiles to enable them to be used on race tracks of other makes

Pair of carbon brushes

60146

for motors of Märklin-Sprint automobiles

Construction system using real nuts and bolts

A technical world in which there was no metal cannot be imagined. And many parts of this world are held together with nuts and bolts. Märklin metal has an important role to play here, as early experience with it is of direct benefit to one's practical engineering skill in later life. Märklin metal models not only look realistic—they work, too. The Märklin metal system offers endless scope to the imaginative or to the practical hobbyist.

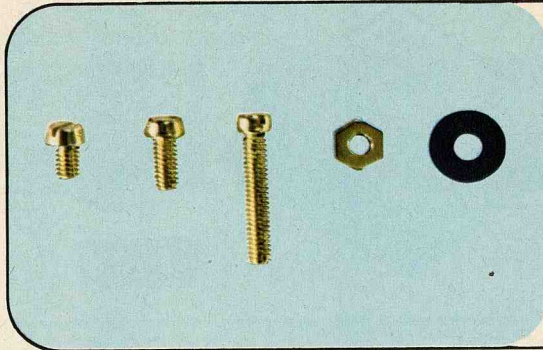

One of the most important things ever invented. The screw thread is ingeniously simple, and for many practical applications there is nothing to beat it. If you master the use of nuts and bolts while enjoying your hobby, you are acquiring valuable technical know-how at the same time.

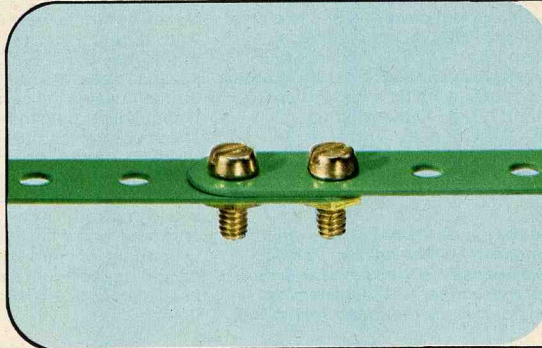

Rugged construction
Structures made with Märklin metal can withstand heavy loads indefinitely, being made of robust materials joined firmly together by nuts and bolts. Märklin models can be used vigorously and for as long as you like.

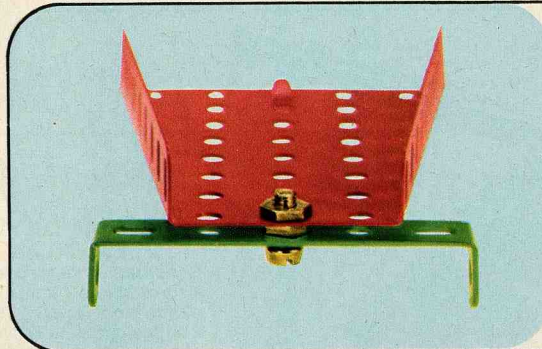

Moving parts add to the fun
Nut and bolt techniques are versatile and instructive. By using non-rigid joints, mechanisms can be devised. All kinds of things can be built up from the simple basic components, with imagination.

Even the tools show clearly the functional character of Märklin metal.

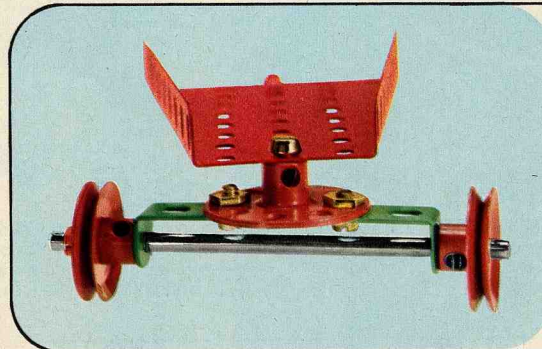
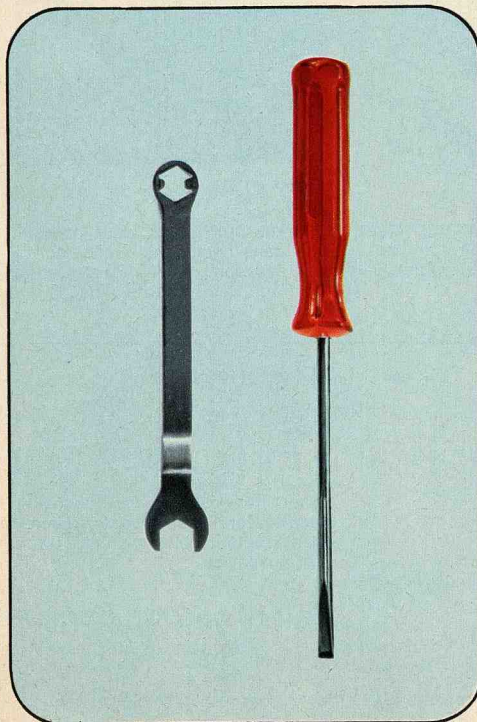

Functional realism
Practical hobbying leads to growth of technical knowledge. Physical problems are encountered and identified. Gear wheels, pulleys, shafts, rollers, wheels, transmission systems: the variety is stimulating and fascinating.

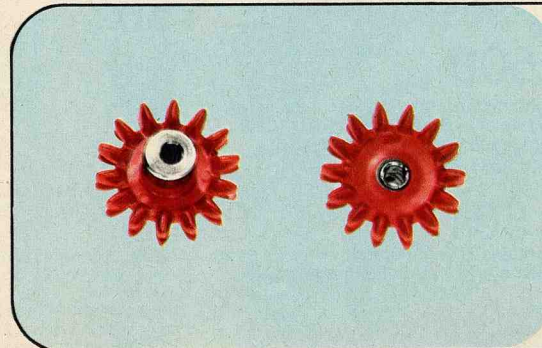

Building and motorizing
A vehicle made of Märklin metal parts is not just strong: it can be motorized, too, as all independently operating models should be. Märklin electric motors add both fun and value to your hobbying.

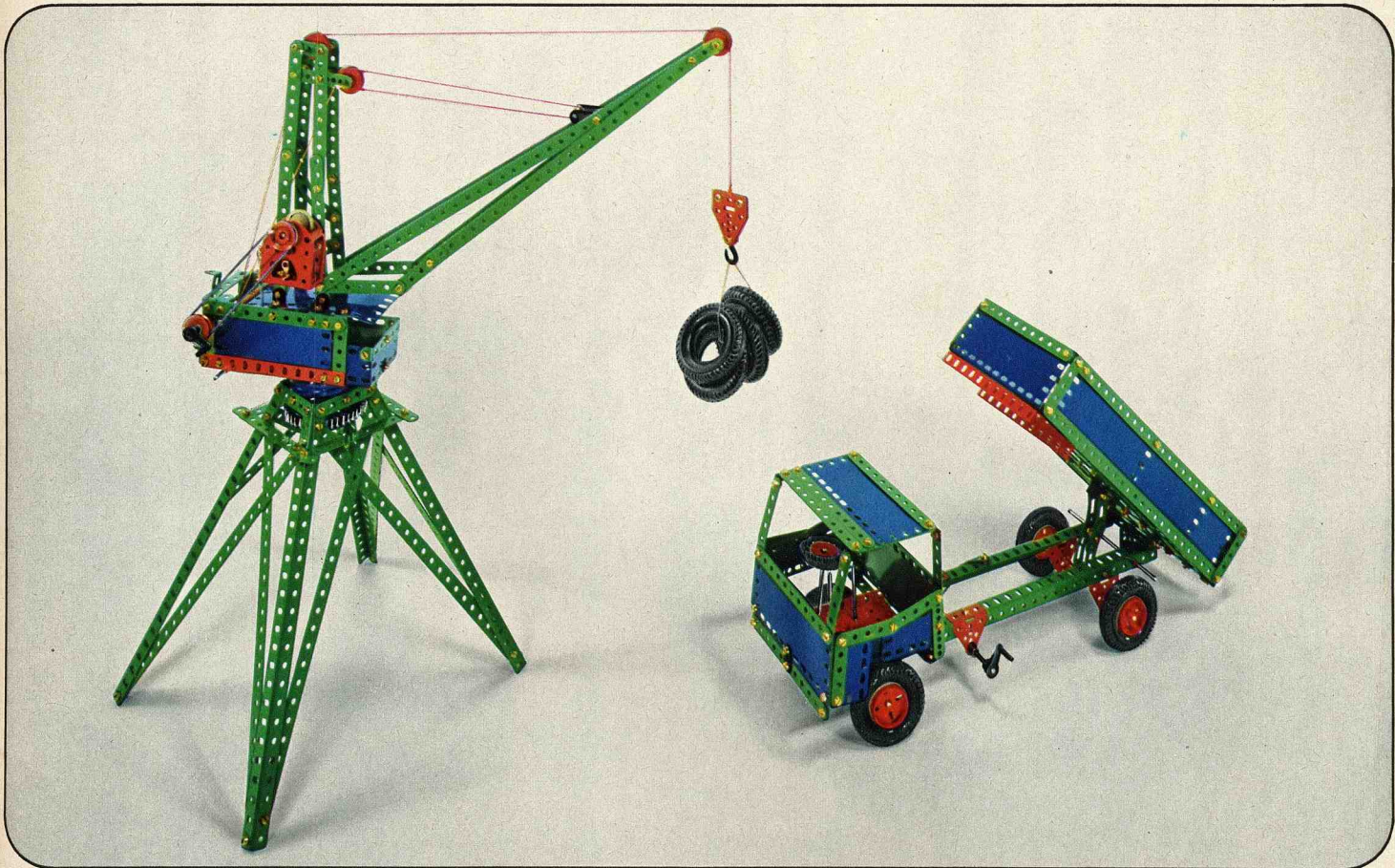
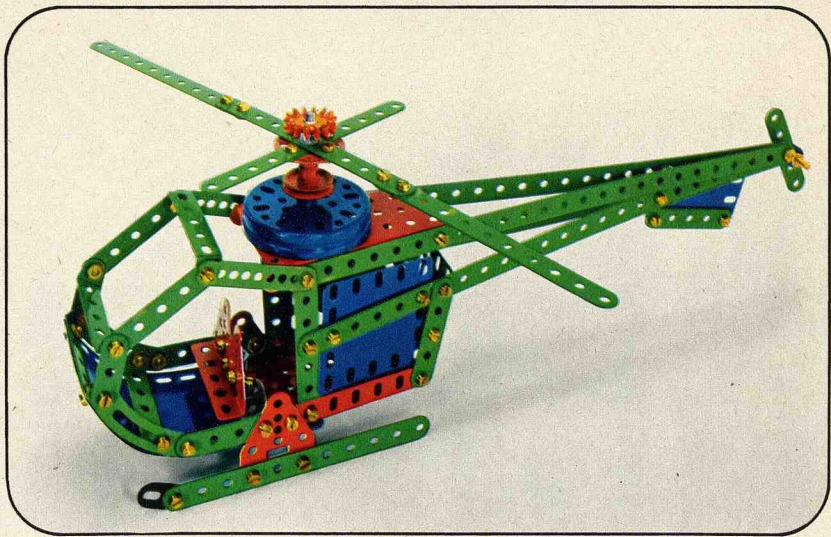
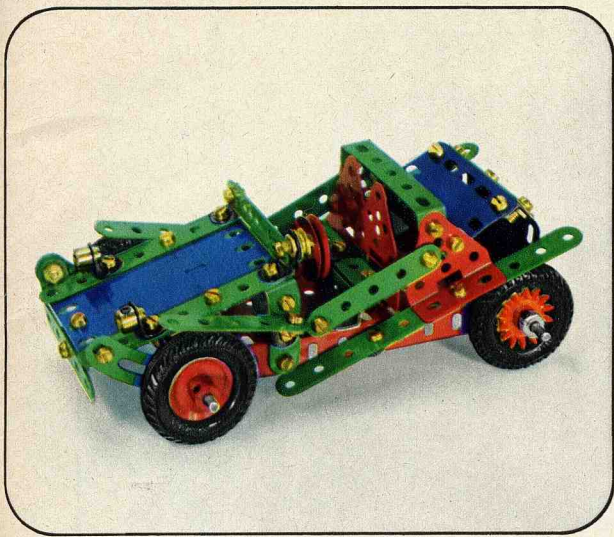

1071

Electric motor · Can be switched for clockwise or anti-clockwise drive · Speed on no load approx. 1500 rpm · Operated at 16 Volts, i.e. from any Märklin HO railroad system transformer · Accessories: 2 leads · Height 6.5 cm · Width 5 cm · Depth 5 cm · Weight 200 g

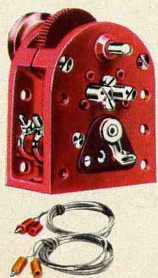

1072 ELEX

ELEX electric motor · 16 Volts · With lead and changeover switch to control direction of rotation · 2 pulley wheels running in opposite directions and at different speeds, as controlled by the transformer · Speeds at no load approx. 3000 and 1100 rpm respectively · Highly efficient motor, suitable for driving Märklin working models of any size and every kind · 3 connector plugs · Height 6 cm · Width 9.5 cm · Depth 6.5 cm · Distance between pulley grooves 8.9 cm · Weight 670 g

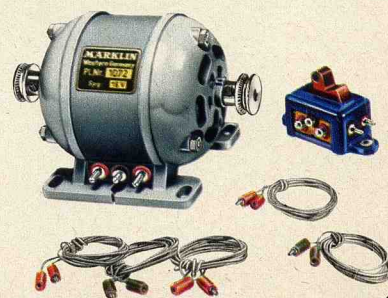

märklin
metall





The construction game for young hands and young imaginations

This construction system has been developed in response to children's requirements. And children will now proclaim the "plus" features of Märklin plus. Its simplicity is immediately apparent: the handy sized bricks just snap together easily, fitting exactly. No crooked walls, no tight spots. No difficulties in construction beyond the capabilities of children. With Märklin plus there are no obstacles to frustrate independent achievements. These achievements are an important factor in children's development. Märklin plus is both simple and versatile. It enables a child's imagination to be exercised in a practical way. It works properly, and it looks right, too.

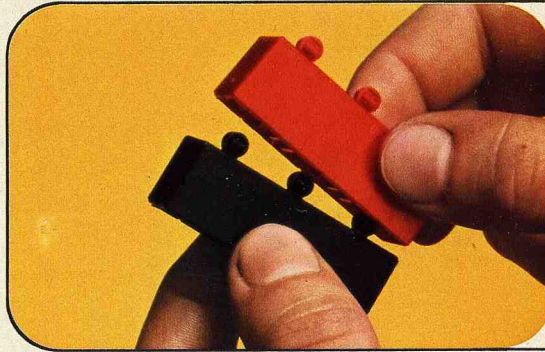

The firm snap connections

Märklin plus basic building blocks snap together with a click and can be pulled apart again easily. Children are quick to appreciate this, as they construct and play with models.

A world of blocks and rods

An unlimited world of Märklin plus opens out, made of basic building blocks, building rods and building plates. With realistic walls, arches and roofs. And with working mechanical models.

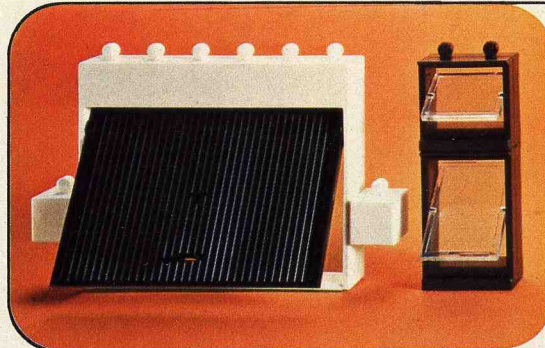
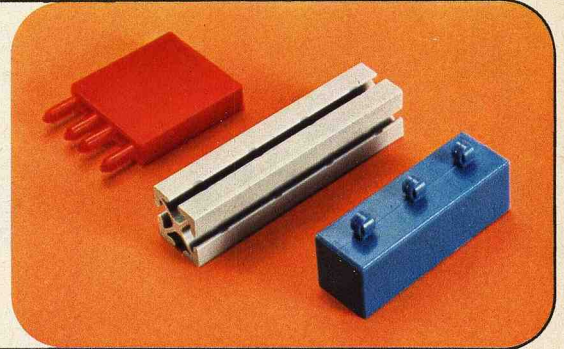

Just like the originals

The Märklin attention to detail is seen particularly clearly here. Windows, doors and garage entrances can be opened, closed, tipped up, etc. You can even fit windows with sliding shutters.

Smart appearance on the road

Automobile building is easy with Märklin plus. You just snap the components quickly and easily together. Wheels run easily and safely by means of well designed axle mountings.

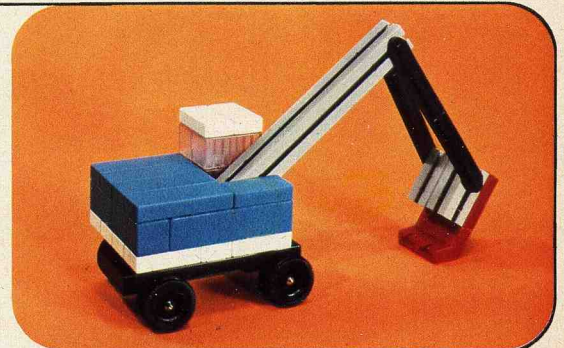

Märklin plus the construction system with educational "plus" features

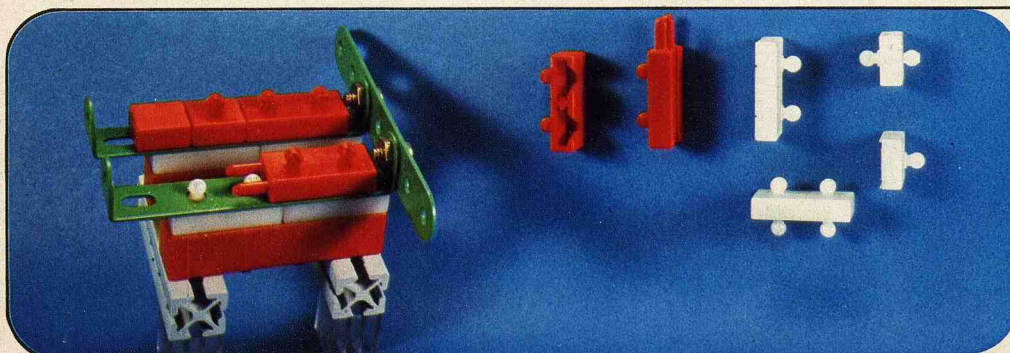

Märklin plus and Märklin metal

The combination of these two Märklin construction systems offers further scope. 6 kinds of special block can be used to join plastic and metal parts together easily and firmly. The two most important materials of modern technology, in fact.



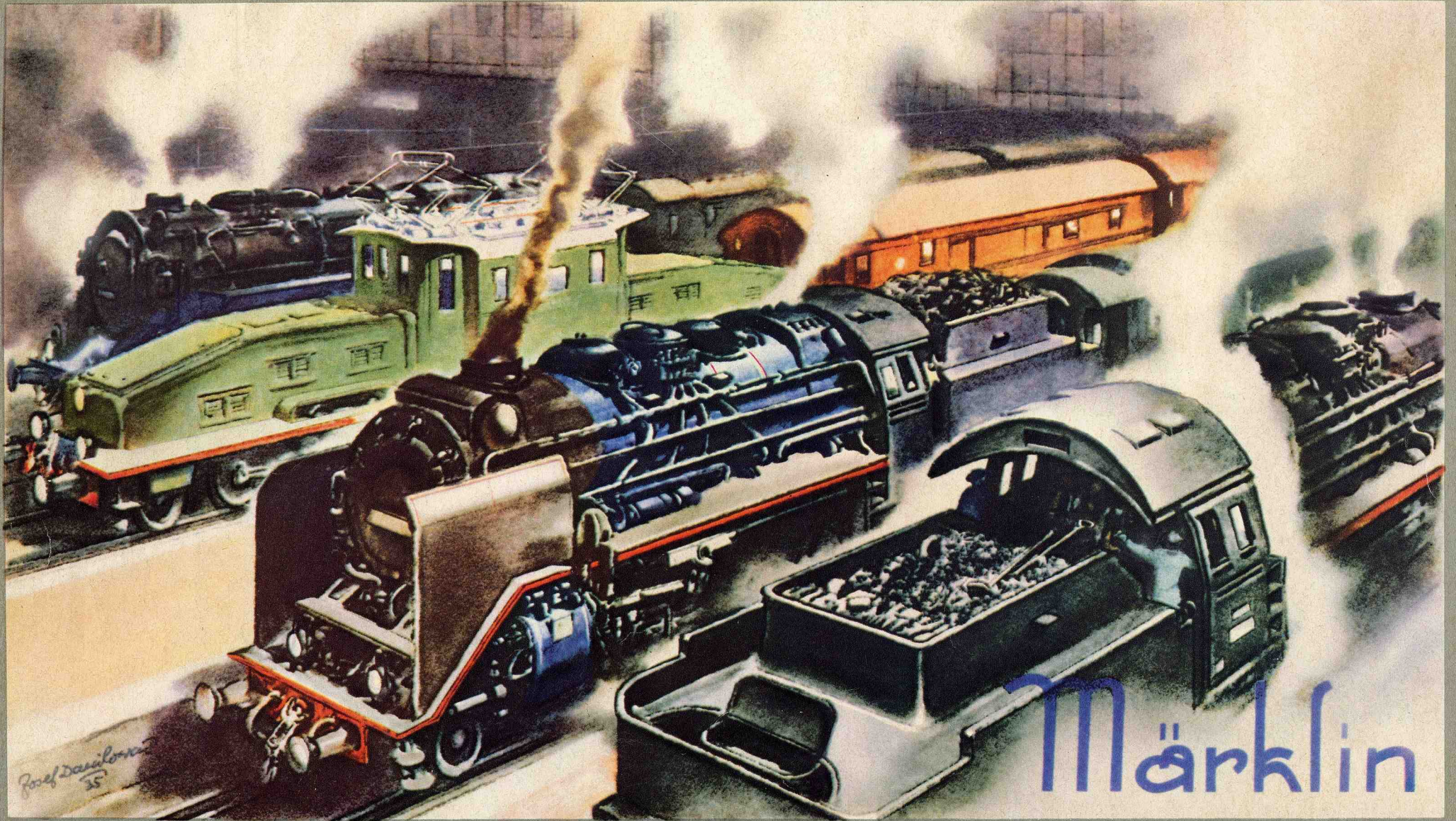

Märklin