

1978'E

mankin

märklin

Gebr. Märklin & Cie. GmbH
D-7320 Göppingen

It is not possible to supply private customers directly from the factory. We reserve the right to make alterations, and availability of stock is not guaranteed. Accuracy of quoted dimensions not guaranteed. - This catalog supersedes all previous issues.

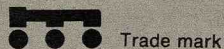

Trade mark

All rights reserved · Copying in whole or in part is prohibited · Printed in Germany by Thiemig AG, Munich · 151 10 - MR 0678 th

märklin HO

Basic sets and their extension 7-13

Train sets 14-15

Locomotives 17-33

märklin HO

Passenger cars 34-43

Freight cars 44-49

märklin HO

Accessories 50-71

Turntable / Locomotive shed	50	Signals	62-64
Rotating crane	51	Station lighting	65
Grade crossings	51-52	Catenary system	66-67
Bridges	53	Leads and control boxes	68
Train lighting	54	Transformers	68-69
Locomotive accessories	55	Publications	70
Tracks	56-61	Märklin magazine	71

Your Märklin dealer:

märklin mini-club

Märklin mini-club

72-91

The mini-club SET program
Railroad sets
Locomotives
Passenger cars
Freight cars

73-75
76-77
78-80
81-83
84-85

Building kits, grade crossing,
bridges, transfer table, signal
Tracks
Catenary system, lighting
Power packs, accessories

86-87
88-89
90
91

märklin I

Märklin I

92-105

The P8
Railroad sets, locomotives
Passenger cars

92- 95
96- 97
98-100

Freight cars
Tracks
Accessories

101-103
104
105

märklin Sprint

Märklin sprint

106-113

Race tracks
Racing and sports automobiles

107-108
109-110

Track sections
Accessories

111
112-113

märklin metall

Märklin metall

114-121

Märklin products are characterized by precision manufacture, quality-controlled production, fantastic reproduction of details from the originals, high reliability and ability to provide unlimited entertainment.

Fitting the electronic direction-control switch in an I-gauge P8 locomotive

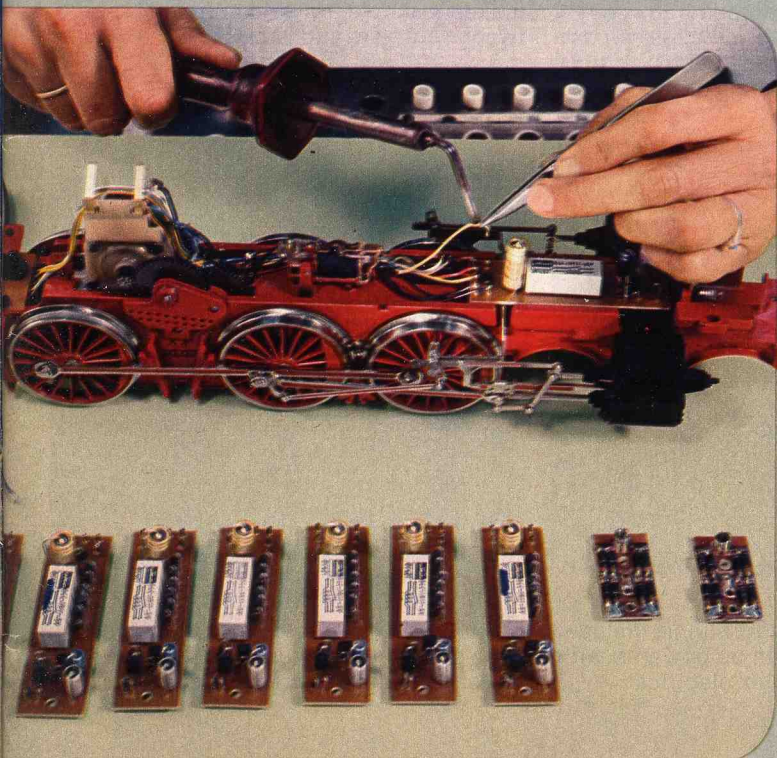

A die cast molding receives a final polish

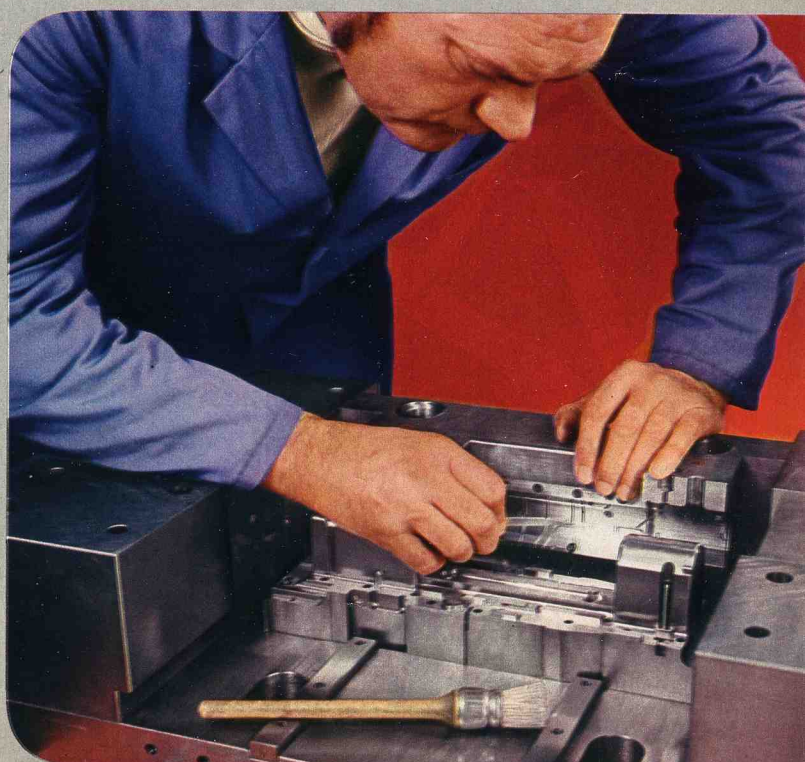

**Märklin HO
for simpler construction
and safer operating**

There are many advantages in planning, building and operating a Märklin HO gauge railroad, from the first train to a fully developed layout. The key feature of the system is the center-conductor technique used with an alternating current supply – an unsurpassed Märklin speciality. The positive current path is not just reliable, it also makes it a simple matter to isolate track sections or provide electrical control.

and the accuracy with which the full-scale originals have been reproduced.

Märklin provide hints and suggestions to help you in extending your layout. These are easy to follow, as is everything in the Märklin HO system with its unsurpassed entertainment value.

The entertainment value is increased by many special Märklin features: the TELEX and RELEX couplings, for instance, which make realistic railroading operations such as switching possible. The handy size of the HO gauge makes for a relaxing and varied leisure activity which can be enjoyed by young railroad enthusiasts as well as by adults, who will particularly appreciate its unfailing reliability in operation, its unlimited versatility

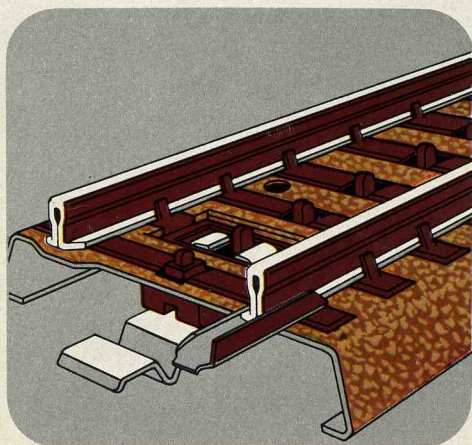

M-track (metal track body)
Triple connection between track sections consisting of a sprung connector for the center conductor and two rail clips.

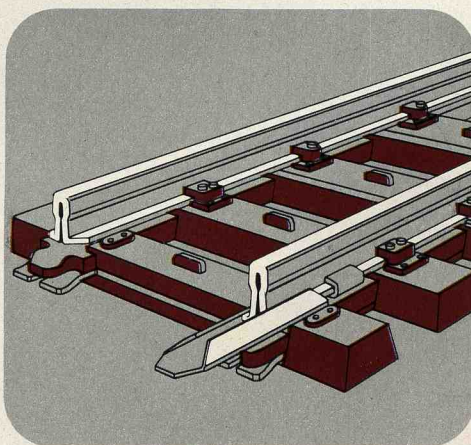

K-track (plastic cross-ties)
Six-fold connection between track sections. Consisting of two rail clips, two sprung connectors for the center conductor and two claw couplings on the tie strip.

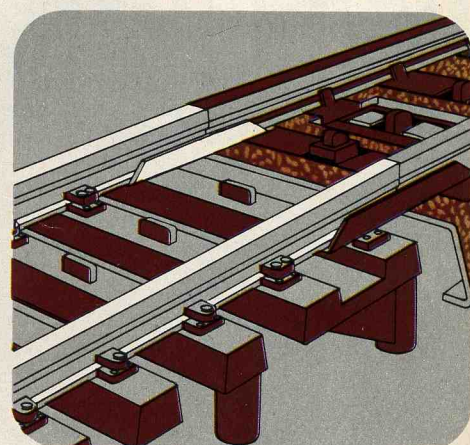

Adapter track section
makes a simple, reliable connection between M-tracks and K-tracks.

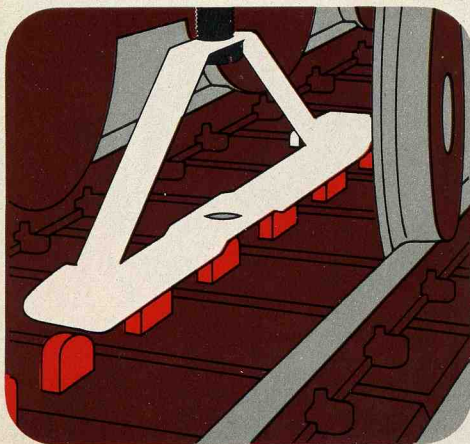

Reliable power supply
to the motor from stud contacts via the pick-up shoe. Current return path via the locomotive wheels on both sides.

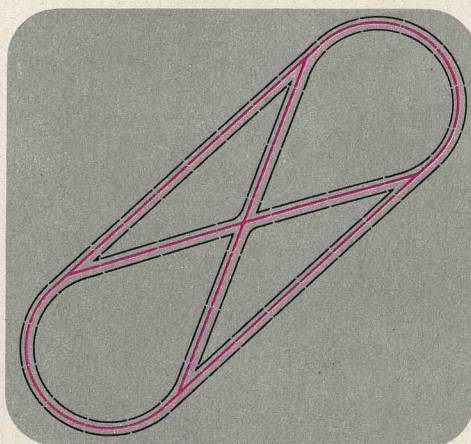

Simple circuitry
All kinds of track configurations, including reversing loops, can be powered without the need for complex electrical switching.

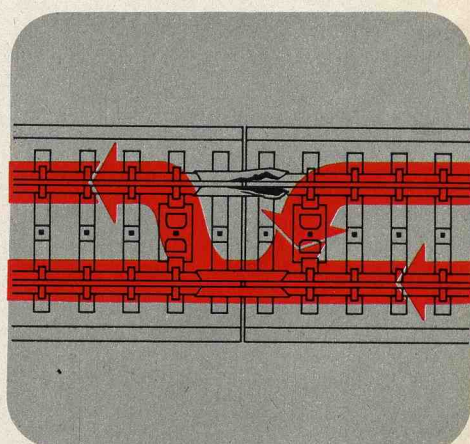

Reliable current path
because even if one of the two rail joint clips should get distorted the other one will still ensure a perfect connection.

Advantages of alternating current and the well-proven center conductor technique

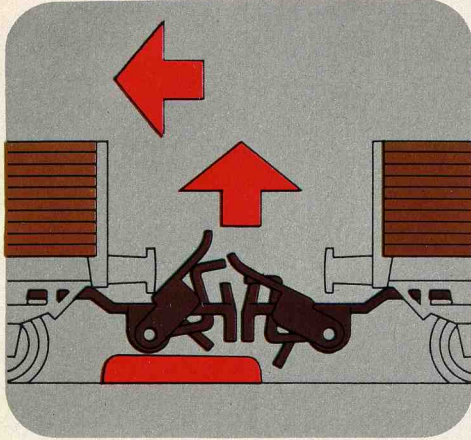

Automatic coupling

When cars are brought into contact the coupling engages automatically. At the uncoupling track section uncoupling can be carried out manually or by remote control.

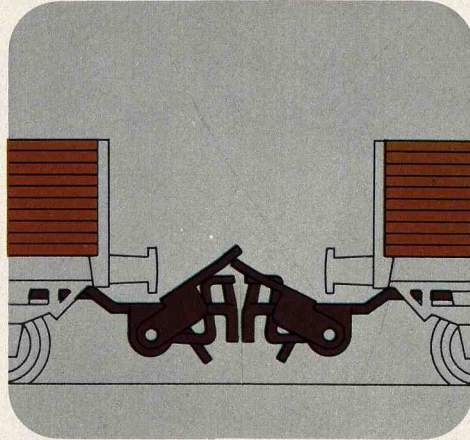

RELEX coupling

After uncoupling, the cars can be pushed for parking without the coupling re-engaging.



TELEX coupling

Uncoupling can be carried out at any point by remote control from the transformer.



Reversing direction of travel of locomotives

by turning the control knob on the transformer (provides an over-voltage pulse).

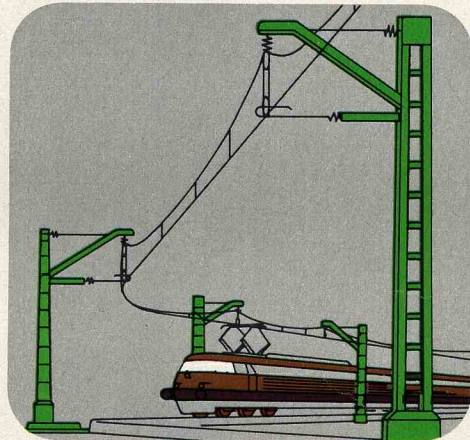

Catenary system

If the overhead line is wired up as a second circuit, two locomotives can be run independently of one another on the same track.

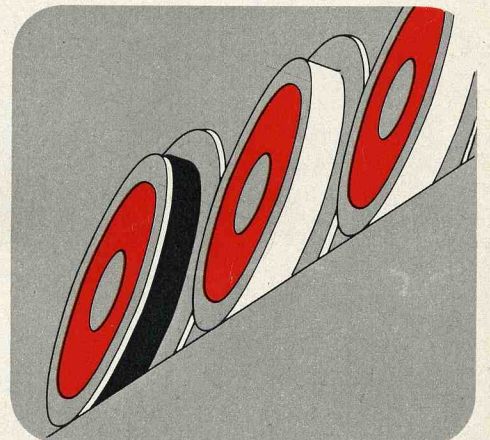

Non-skid tires

are used on every locomotive to increase tractive force by improving the grip of the wheels on the rails.

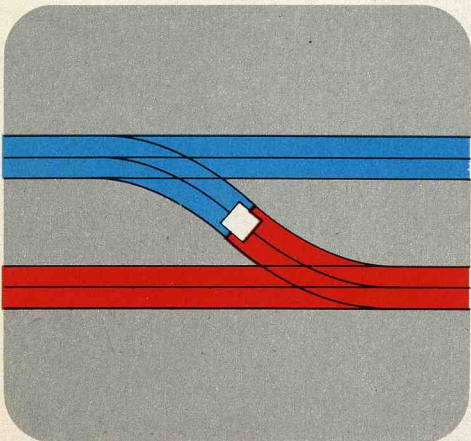

Circuit isolation

using center conductor isolator 5022 for M-tracks, or center conductor isolator 7522 for K-tracks. Special isolating track sections are not required.

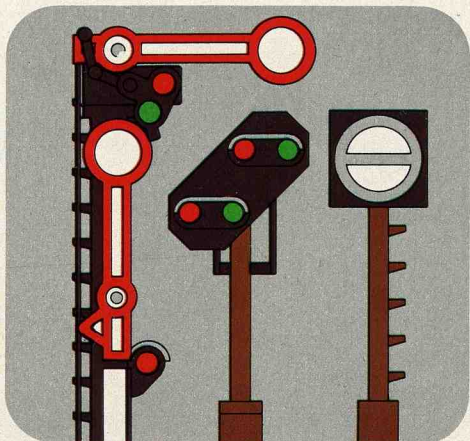

Signals

enable trains to be controlled fully automatically.

Radio interference suppression

All locomotives are fitted with suppressors. Compliance with German legal requirements for suppression is guaranteed, provided that feeder track sections 5131 or 2192, or the feeder masts 7201 or 7501 are used, and that exclusive use is made of Märklin items, which are matched for suppression purposes together with the Märklin transformers recommended.

märklin
H0

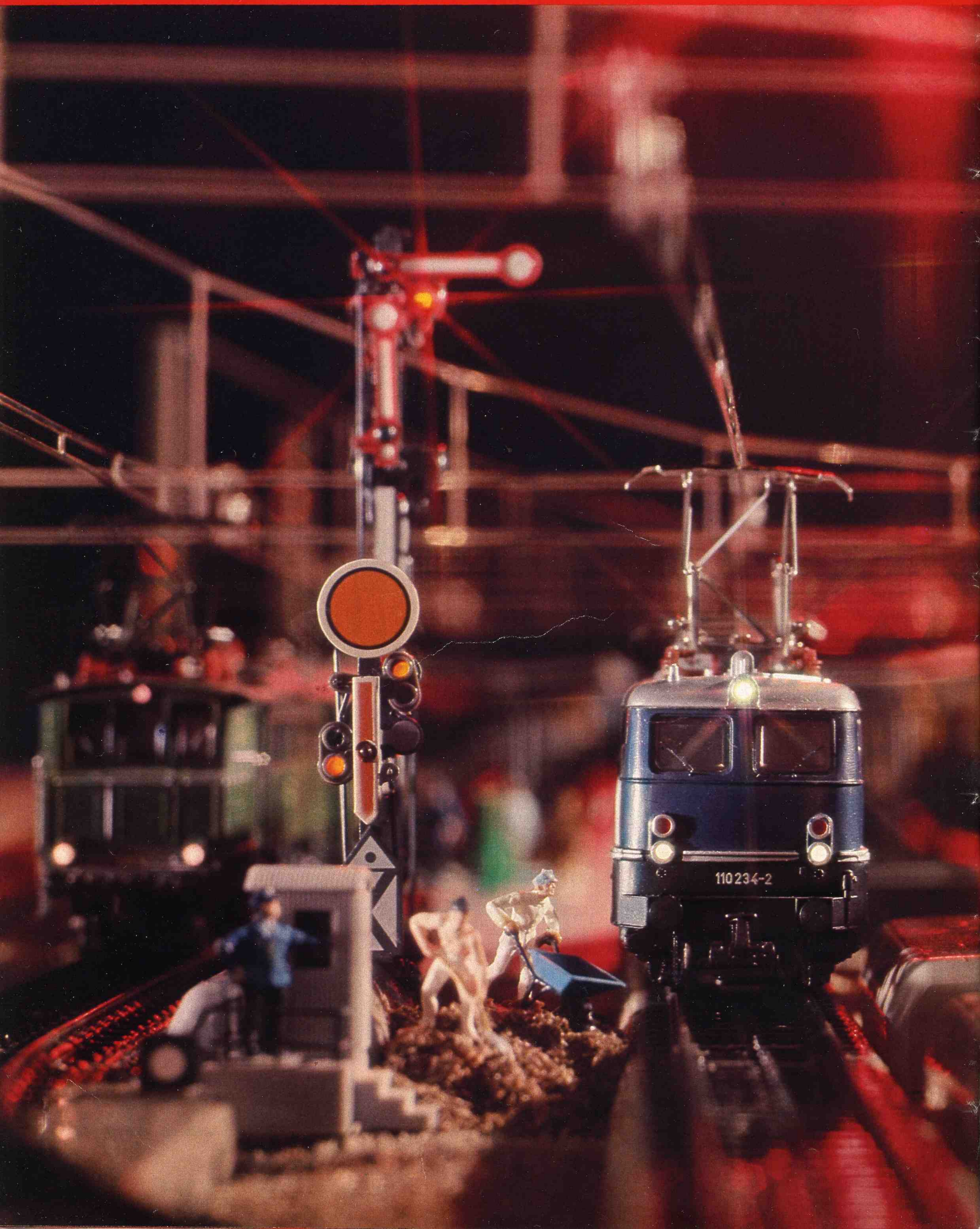





By arranging additional electrical circuits, e.g. by a catenary system or by circuit isolation, which is very simple with the Märklin system, several trains can be controlled individually.

Cars can be uncoupled automatically. Trains can be assembled. In fact it's just like a real marshaling yard.



Signals are operated from a control panel in the same way as on real railroads. "Proceed" for the express. "Halt" for the freight train. Multi-train operation controlled by signals. Without collisions, of course.

The rotating crane is operated remotely by push-button control on the control panel. Loading operations are carried out realistically with the aid of the lifting magnet and load hook.

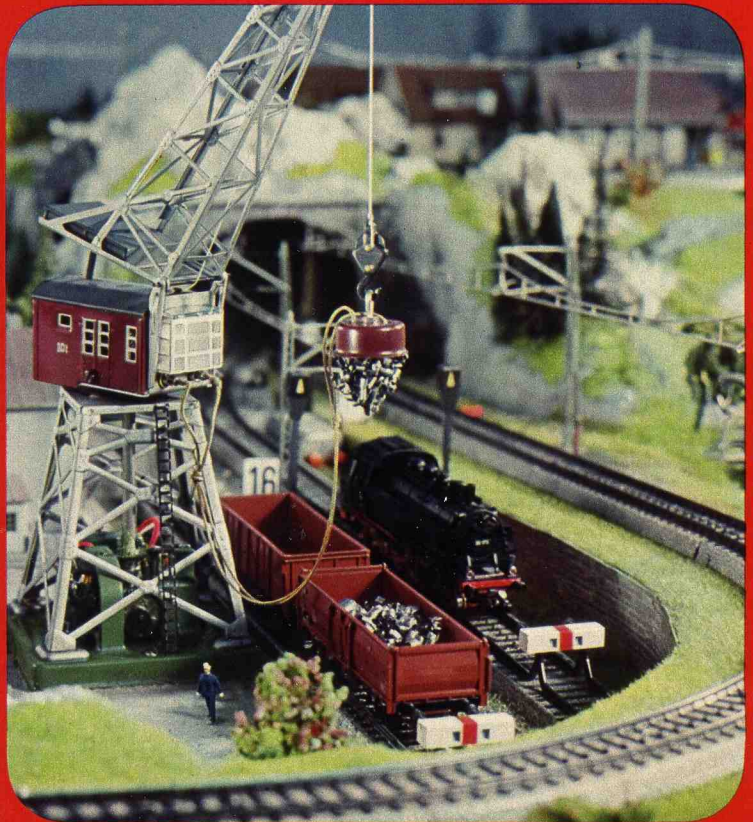

Gift sets for a good start complete with transformer, for immediate use. A good basis for later extension.

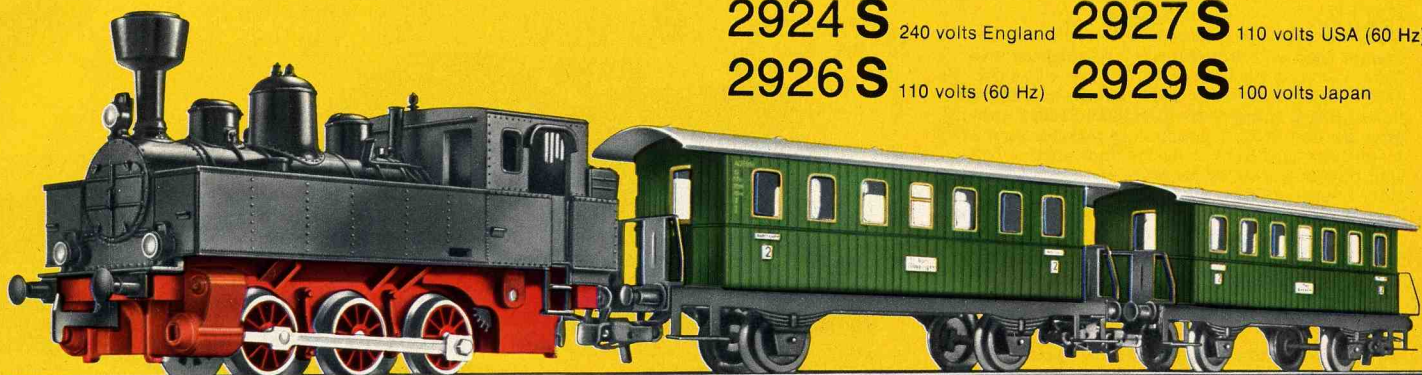

2924 S 240 volts England **2927 S** 110 volts USA (60 Hz)
2926 S 110 volts (60 Hz) **2929 S** 100 volts Japan

All train sets on this page have an oval track and a transformer with traction and lighting current connections.

2920 S 220 volts
Local passenger train with transformer · With tank locomotive, 2 passenger cars, 12 curved track sections 5100, 1 straight track section 5106, 1 feeder track section 5131 with built-in capacitor for radio interference suppression and 1 transformer · Length of train 35 cm (1ft. 1³/₄"')

Like all Märklin railroad transformers, the ones included in these sets have connections for traction current and current for lights and solenoid-operated items, as well as providing an overvoltage for reversing the locomotives. These transformers can also be used to provide power for bigger locomotives or additional turnouts or signals.



The transformers supplied with these basic sets are not available separately.



2934 S 240 volts England **2937 S** 110 volts USA (60 Hz)
2936 S 110 volts (60 Hz) **2939 S** 100 volts Japan

Fully extendable basic sets

2930 S 220 volts
Freight train with transformer · With locomotive 3000, 2 freight cars, 12 curved track sections 5100, 1 straight track section 5106, 1 feeder track section 5131 with built-in capacitor for radio interference suppression and 1 transformer · Length of train 34.5 cm (1ft. 1¹/₂"')

For basic sets 2920–2929 and 2930–2939 we recommend the Märklin SET-HO, an extension program building up to the ideal HO layout, using items E (5190, 5191), T1 (5192), T2 (5193) and T3 (5194). See page 10 for detailed descriptions.



Connect transformers to Alternating Current (AC) mains supply only.



märklin HO

Large train set – the best start for young railroaders

2950 **new**

220 volts

Freight train with transformer · With locomotive 3000, 1 tipping bucket car 4413, 1 low-sided car 4423, 1 open freight car 4430, 13 curved track sections 5100, 5 straight track sections 5106, 1 straight track section 5107, 1 uncoupling track section 5112, 1 light standard 5113, 1 feeder track section 5131 with built-in capacitor for radio interference suppression, 1 turnout 5221, 1 control box 7072, 1 bumper 7190, leads, plugs, sleeves, simulated freight, 1 transformer and one operator's booklet · Length of train 47.5 cm (1 ft. 6³/₄"')



Gift pack with grade crossing

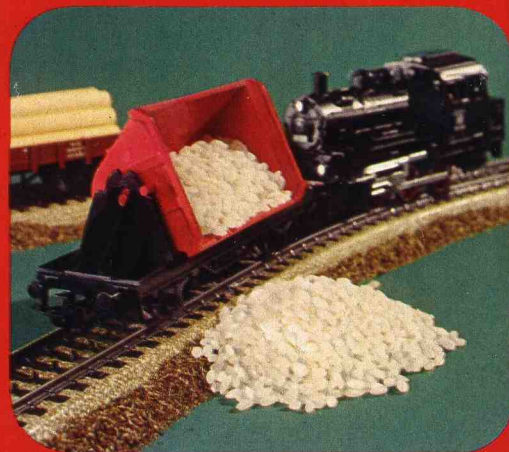
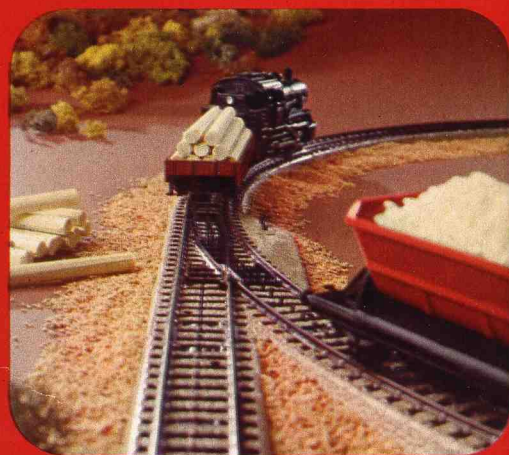
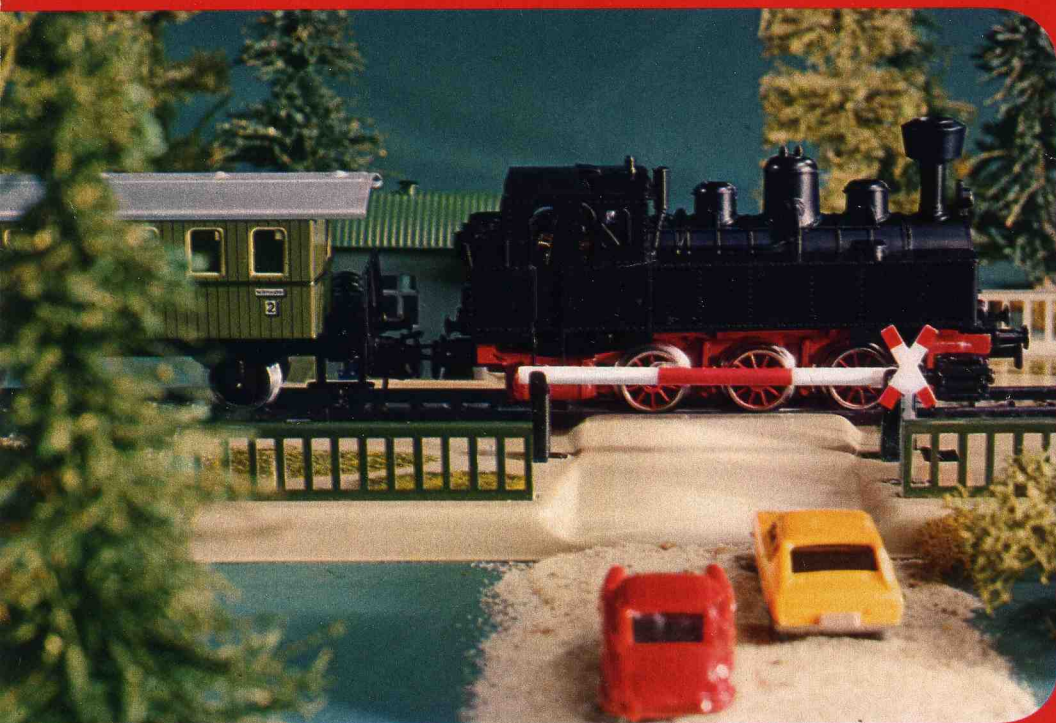

2940 **new**

220 volts

Passenger train with grade crossing and transformer · With tank locomotive, 2 passenger cars, 12 curved track sections 5100, 2 straight track sections 5106, 1 feeder track section 5131 with built-in capacitor for radio interference suppression, 1 mechanically operated grade crossing 7390, 2 automobiles and 1 transformer · Length of train 35 cm (1 ft. 1³/₄"')



Assemble and then play
as long as you like

2954 new
240 volts England

2957 new
110 volts (60 Hz)

2959 new
100 volts Japan

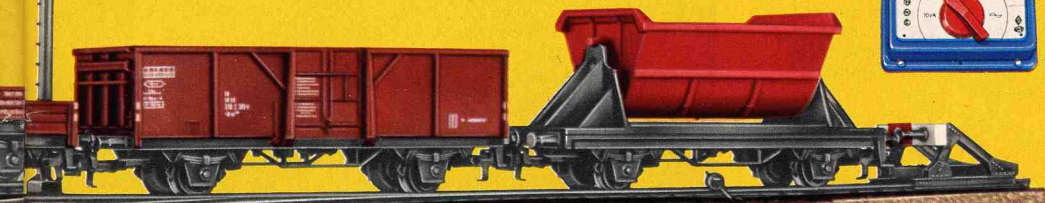

This large train set has been compiled to make a wide variety of railroading operations possible:

controlling, operating, loading, setting switches, unloading, marshaling and layout building

- assemble and modify your own layout
- become familiar with electrical technology
- two (or more) can play!
- make plans, develop your own ideas

The color-printed operator's booklet contains many ideas for both using and extending this large train set.

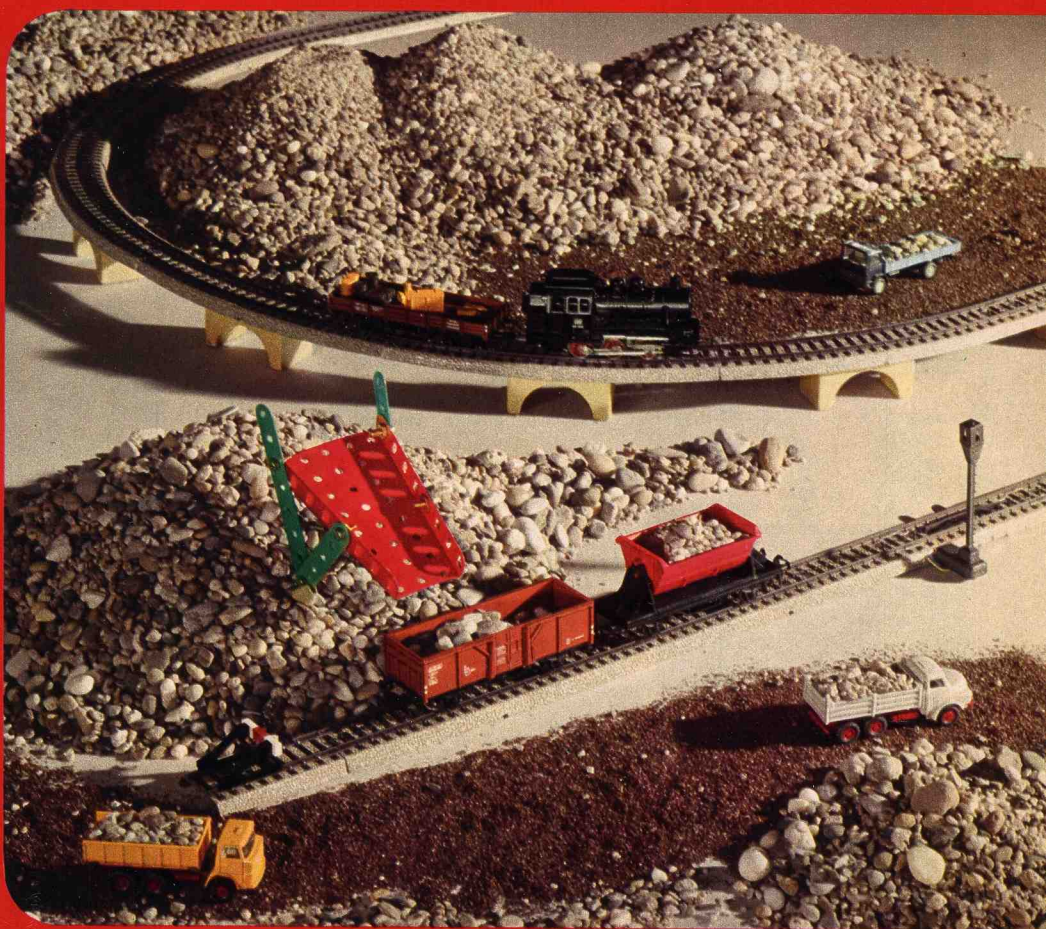
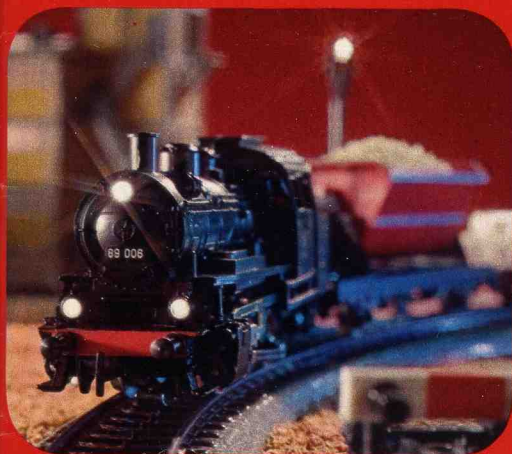

2944 new
240 volts England

2947 new
110 volts (60 Hz)

2949 new
100 volts Japan



Like all Märklin railroad transformers, the one included with these railroad sets has connections for traction current, lighting current and current for solenoid-operated items. It also provides the overvoltage pulse used to change a locomotive's direction of motion. Additional turnouts, signals or larger locomotives can also be powered from this transformer.

The transformers supplied with these basic sets are not available separately.

Connect transformers to Alternating Current (AC) mains supply only.

SET-HO

All Märklin HO basic sets can be extended. The SET-HO extension program is recommended as a particularly good method:

The first stage is extension stage E5190 or extension stage E5191.



5190

Extension set E · Contents:
10 straight track sections 5106,
2 curved track sections 5206, one pair
of manually operated turnouts 5221
and instructions for extending
the layout



5191

Extension set E · Contents:
10 straight track sections 5106, 1 pair
of solenoid-operated turnouts 5202,
2 curved track sections 5206,
1 control box 7072, 1 distribution
strip 7209, connector materials
such as leads, sleeves and plugs ·
Instructions for extending the layout



5192

Double track set T1 · Contents:
2 curved track sections 5100,
6 straight track sections 5106, 1 pair
of solenoid-operated turnouts 5140,
6 curved track sections 5200, 1
control box 7072, 1 distribution strip
7209, connector materials such as
leads, sleeves and plugs · Instructions
for extending the layout



5193

Station track set T2 · Contents:
2 curved track sections 5100, 6 straight
track sections 5106, 2 straight track
sections 5129, 1 pair of solenoid-
operated turnouts 5140, 1 straight
track section 5210, 1 control box
7072, 1 distribution strip 7209,
connector materials such as leads,
sleeves and plugs · Instructions
for extending the layout



5194

Switching track set T3 · Contents:
9 straight track sections 5106, 1 pair
of solenoid-operated turnouts 5202,
1 double slip switch 5207, 1 control
box 7072, 4 bumpers 7190, 1 distribu-
tion strip 7209, connector materials
such as leads, sleeves and plugs ·
Instructions for extending the layout

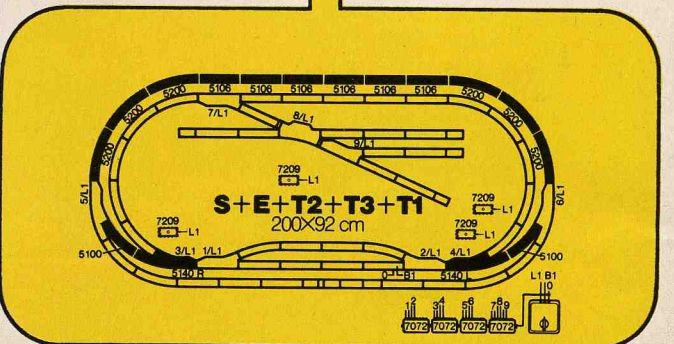
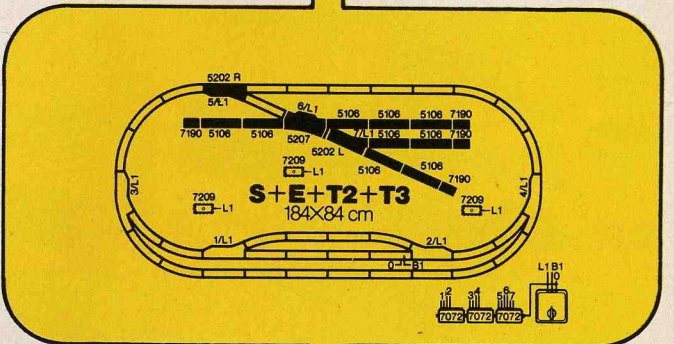
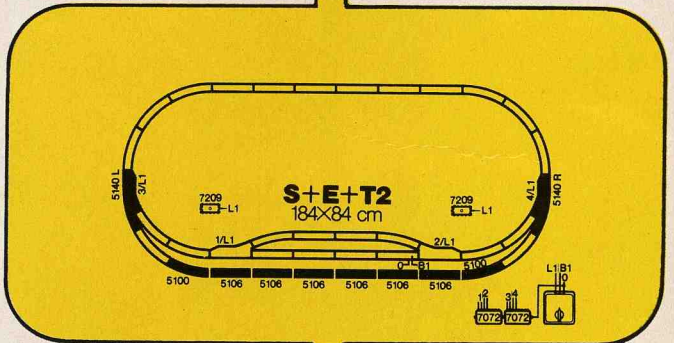
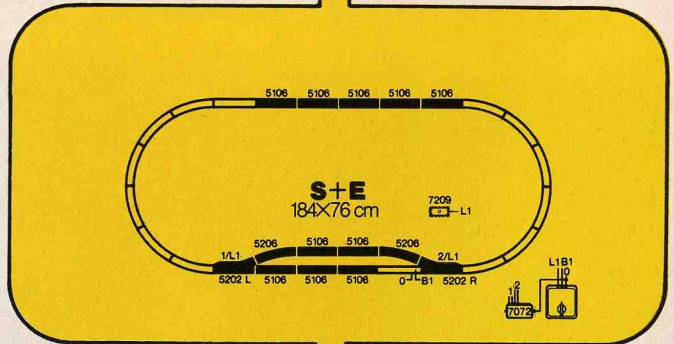
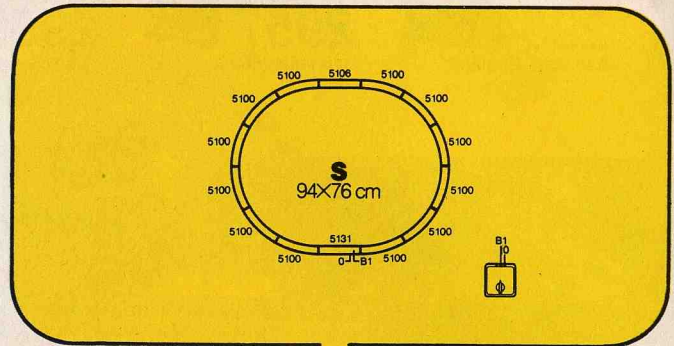

The way to a fine layout

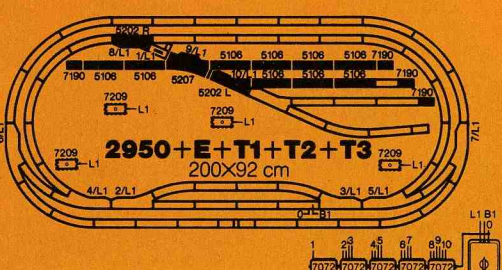
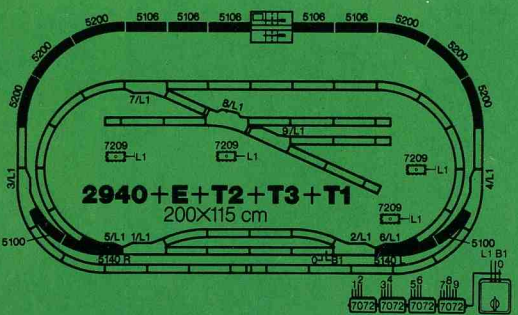
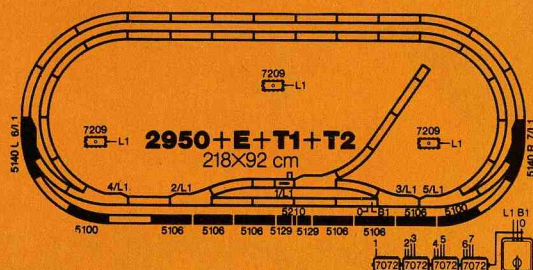
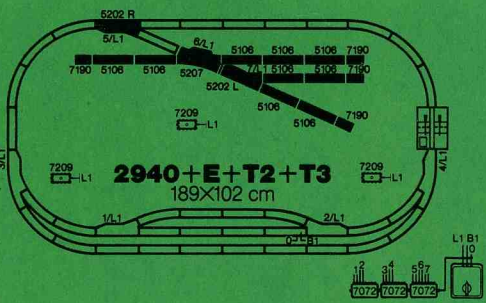
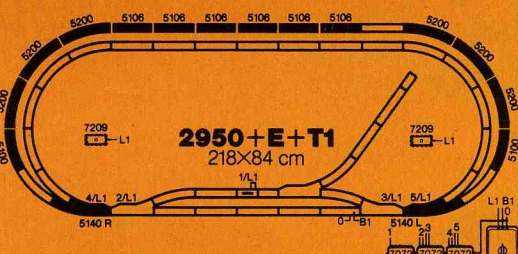
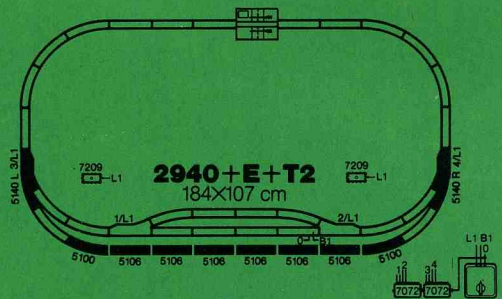
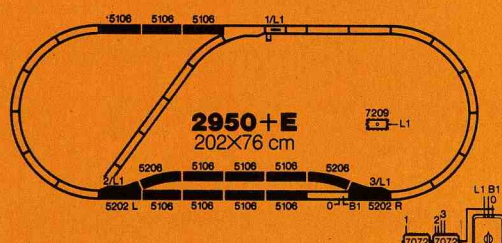
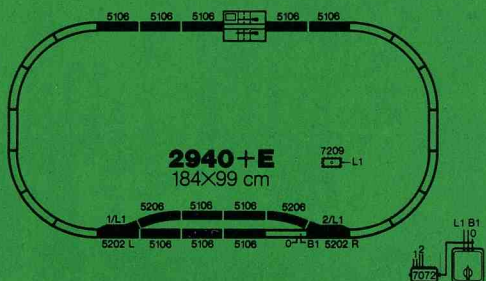
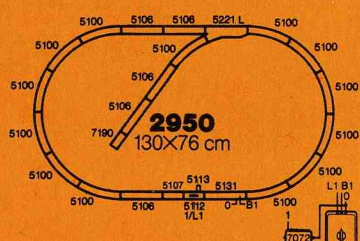
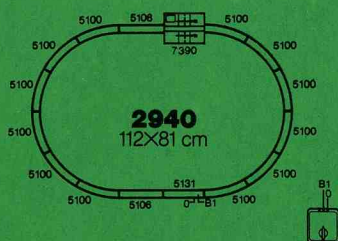

With current supply from overhead line

The following items are required for the SET-HO layout with basic sets 2920-2929 and 2930-2939:

- 3-7004
- 54-7009
- 10-7013
- 16-7014
- 16-7015
- 22-7018
- 7-7019
- 9-7023
- 1-7201
- 1-7277
- 2-7278

1 30 VA transformer

205 × 97 cm
(6 ft. 8³/₄" × 3 ft. 2¹/₄")

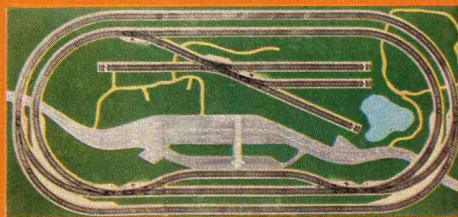
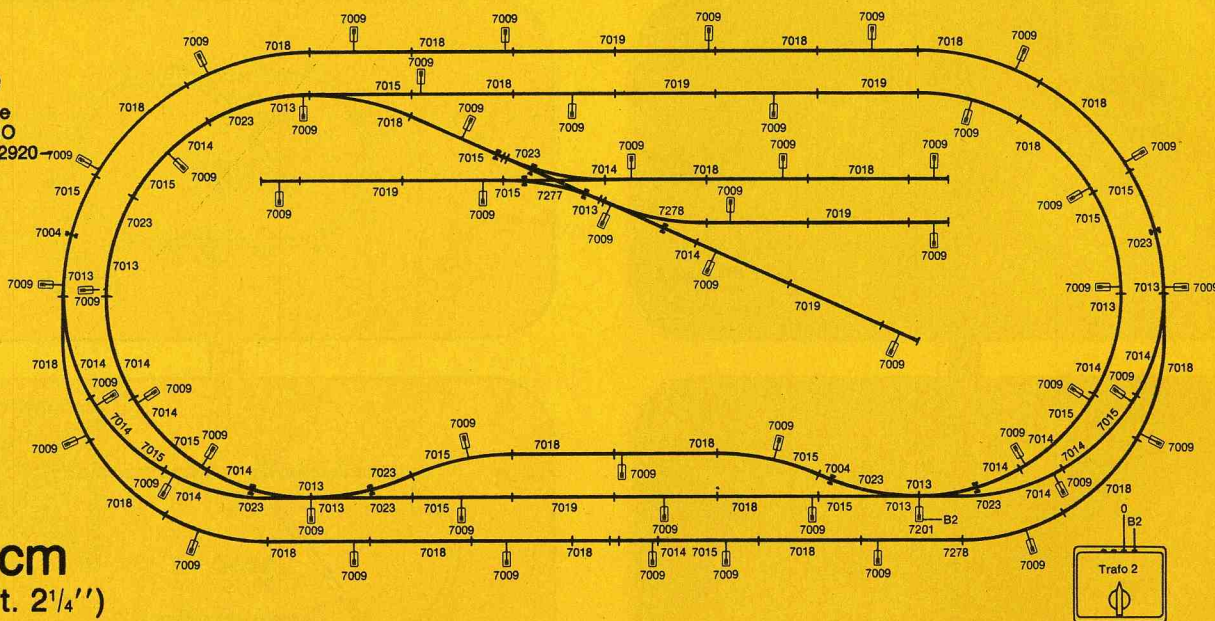

7298

Märklin-Toporama for the Märklin SET-HO extension program with basic sets 2920-2929 and 2930-2939 · Realistic printed model railroad landscape · Multicolored

design · Track layout up to SET 123 is printed on · Tufted grass areas give three dimensional effect · Size 205 × 97 cm (6 ft. 8³/₄" × 3 ft. 2¹/₄")



Catenary system



Switching



Bridge



Rotating crane



Märklin HO can be extended indefinitely

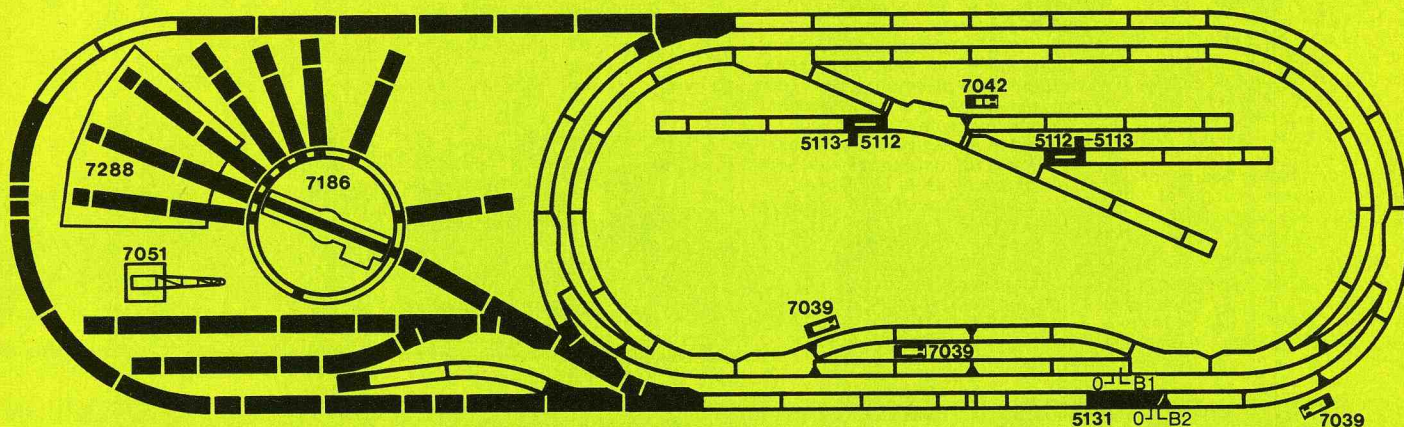

This example represents many possible ways:

- Converting the parking tracks from T3 into a genuine marshaling yard, with uncoupling track sections and a track closure signal
- Developing the passing track from E to make a station with exit signals
- Developing multi-train operation by using a catenary system (page 12) and by electrical isolation of parallel tracks
- Extending the oval track by adding a parking yard with locomotive shed and turntable
- Incorporating a freight yard with rotating crane
- Extending the layout for corner fitting

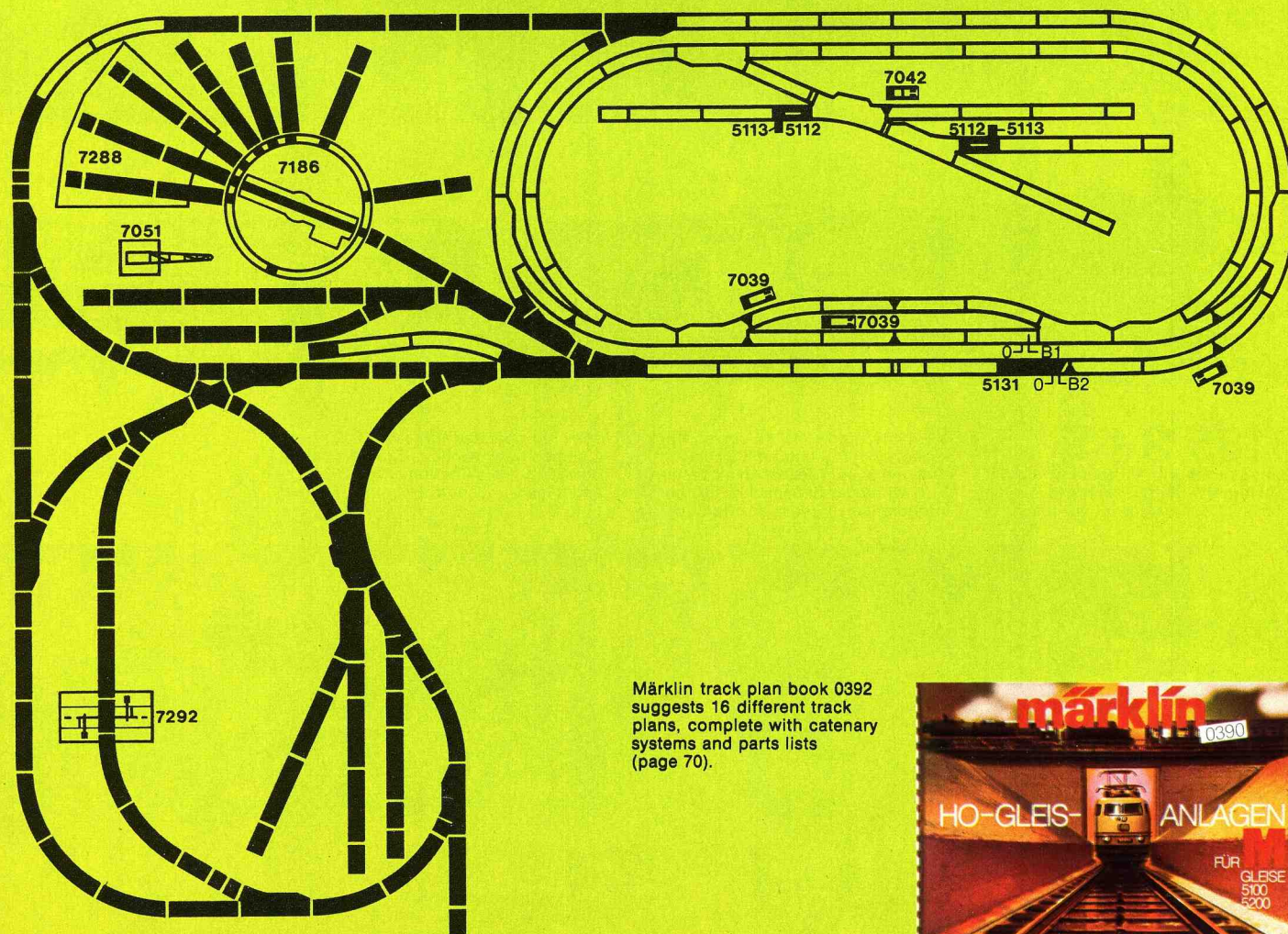

Märklin track plan book 0392 suggests 16 different track plans, complete with catenary systems and parts lists (page 70).

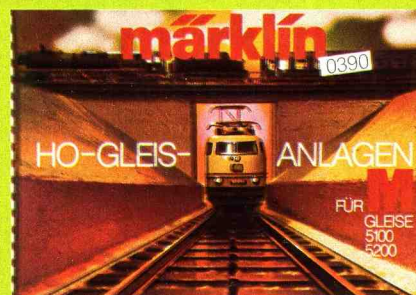

2850 **new**

Express train gift set · With electric express locomotive E0414 in the original lettering of the former German State Railways · Also contains 2 express coaches 4136 (C4ü bay 11) and 1 express baggage car 4137 (Pw4ü bay 09) · Slide-in destination boards for particular routes · Length of train 85 cm (2 ft. 9½")

In 1932 the firm of AEG was commissioned by the former German State Railways to build the type E04 locomotive for use on the express service between Munich and Stuttgart. Although this was

the original plan, the first machines to be delivered, in 1933, were put into service on routes in central Germany, and deliveries to the Munich railway administration did not take place until later. The maximum speed of the first eight locomotives was 110 km/h (68 mph), and this was raised to 130 km/h (81 mph) for all subsequent machines. In high speed trials on 28 June 1933, locomotive E 04.09, pulling a load of 309 tons, achieved a cruising speed of 145 km/h (90 mph) on the line between Munich and Stuttgart, and a maximum speed of 151.5 km/h (94 mph) on the line between Munich and Augsburg.

See page 27 for the technical description of express locomotive E 04 and page 36 for express coaches 4136 and 4137.



3185 **S + E**

Express train with turnouts (without transformer) · With express locomotive 3085, 1 each express coach

4092, 4093 and 4094, 12 curved track sections 5100, 11 straight track sections 5106, 1 feeder track section 5131 with built-in capacitor for radio interference suppression, 1 pair of

solenoid-operated turnouts 5202, 2 curved track sections 5206, 1 control box 7072, 1 distribution strip 7209 and 2 leads · Length of train 113 cm (3 ft. 8½")



3203 **S**

Freight train (without transformer) · With locomotive 3003, 3 freight cars, 12 curved track sections 5100, 1 straight track section

5106 and 1 feeder track section 5131 with built-in capacitor for radio interference suppression · Length of train 57 cm (1 ft. 10½")

For those who like the pre-war trains E04 with express coaches

In 1911, the coach building firm of J. Rathgeber in Munich supplied 20 type C4ü – bay. 11 express coaches for the Royal Bavarian Railways, and the firm of MAN in Nürnberg supplied a further 14. These cars, which weighed 40.4 tons each, contained 64 passenger seats and were provided with gas lighting and steam heating. They were given the serial numbers "München 13031 – 13064".

After being incorporated in the stocks of the German State Railway Company in 1924, the cars were gradually modified to receive electric lighting, sleeve buffers and strengthened couplings. From 1931 onward the cars still in service went under the serial numbers "17936 – 966 München".

The first batch of express baggage cars type Pw4ü – bay. 09 supplied by the

Munich firm Rathgeber in 1909 consisted of 12 vehicles. They were provided with gas lighting and steam heating, and their empty weight was 29.6 tons. They would take a freight load of 8 tons, 20 further cars of this type were ordered later. Serial numbers of the first batch: 17667–678, of the second batch: 17864–873 and of the third batch: 17851–860.

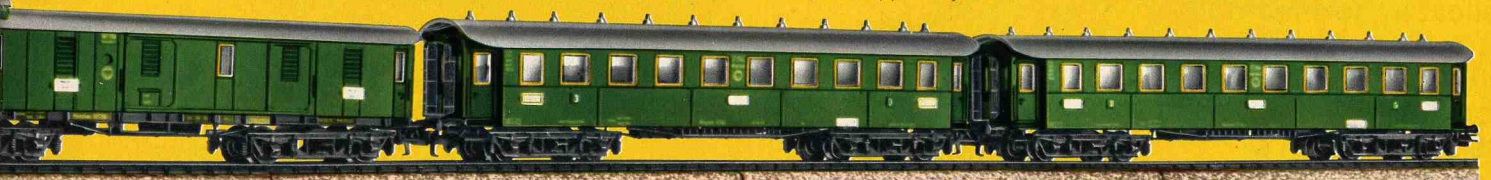

For enlarging train set 3185 we recommend using the following items from the Märklin SET-HO extension program: T 1 (5192), T 2 (5193) and T 3 (5194). For detailed descriptions see page 10.



For enlarging train set 3203 we recommend Märklin SET-HO, an extension program leading to the ideal HO layout, using items E (5190, 5191), T 1 (5192), T 2 (5193) and T 3 (5194). For detailed descriptions see page 10.

Märklin locomotives are masterpieces of realistic model engineering. The reliable working models are composed of many precision made parts. Delicately formed and yet robust. More than 100 years' experience of modeling – that is the basis of Märklin's success.

Freight train locomotive 3082 with tender

Item No. Description

- 1 Locomotive body (complete) with
- 2 Smoke deflector plate (right)
- 3 Smoke deflector plate (left)
- 4 Lamp carrying handle
- 5 Lighting fitting
- 6 Cheese-head screw
- 7 Driving truck (complete) with
- 8 Cluster gear
- 9 Bearing pin
- 10 Idler gear
- 11 Gear wheel
- 12 Part of driving axle with
- 13 Non-skid tire
- 14 Part of driving axle
- 15 Part of driving axle
- 16 Driving wheel with non-skid tire
- 17 Driving wheel
- 18 Driving wheel
- 19 Buffer
- 20 Field magnet
- 21 Armature
- 22 Motor end plate
- 23 Cheese-head screw
- 24 Pair of brushes

- 25 Side rod
- 26 Hexagonal headed shoulder bolt
- 27 Hexagonal headed shoulder bolt
- 28 Drive rod assembly (right)
- 29 Drive rod assembly (left)
- 30 Hexagonal nut
- 31 Insulating strip
- 32 Cheese-head screw
- 33 Cylinder (right)
- 34 Cylinder (left)
- 35 Hollow rivet
- 36 Dummy underframe
- 37 Spring plate
- 38 Light bulb
- 39 Steering arm
- 40 Coupling hook
- 41 Cheese-head shoulder bolt
- 42 Truck (complete)
- 43 Steering arm
- 44 Leaf spring
- 45 Truck (complete)
- 46 Retaining ring

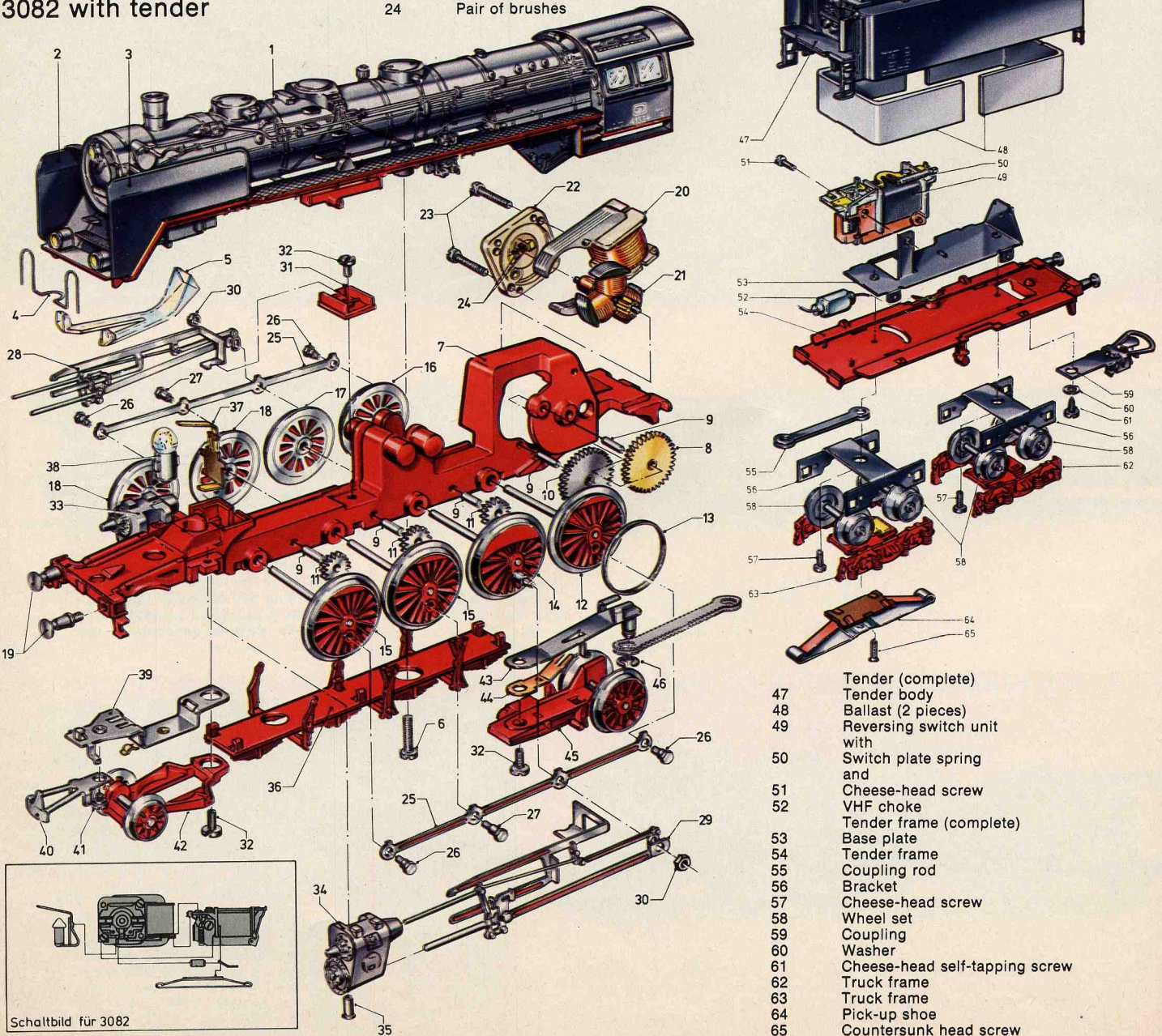

- 47 Tender (complete)
- 48 Tender body
- 49 Ballast (2 pieces)
- 50 Reversing switch unit with
- 51 Switch plate spring and
- 52 Cheese-head screw
- 53 VHF choke
- 54 Tender frame (complete)
- 55 Base plate
- 56 Tender frame
- 57 Coupling rod
- 58 Bracket
- 59 Cheese-head screw
- 60 Wheel set
- 61 Coupling
- 62 Washer
- 63 Cheese-head self-tapping screw
- 64 Truck frame
- 65 Truck frame
- 66 Pick-up shoe
- 67 Countersunk head screw

Steam locomotives



Tank locomotive

3087

Tank locomotive modeled on a 0-6-0 type used on branch lines · 1 driven axle · 2 non-skid tires · Remote control for forward and reverse drive · Green and black body · Green

water tanks and driver's cab · Die cast zinc frame · Coupling hooks at each end · Length over buffers 10.8 cm (4¹/₄"')

⊖ = 7154 ⚙ = 7185

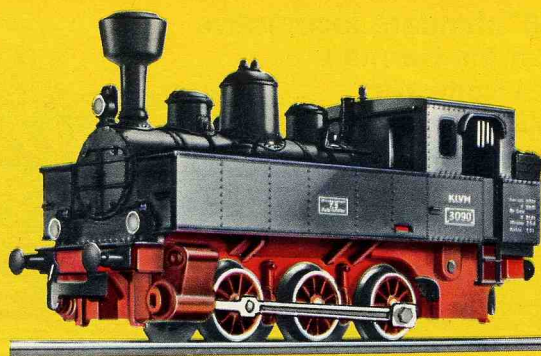

Tank locomotive

3090

Tank locomotive modeled on a 0-6-0 type used on branch lines · 1 driven axle · 2 non-skid tires · Remote control for forward and reverse drive · Mat black body ·

Die cast zinc frame · Coupling hooks at each end · Length over buffers 10.8 cm (4¹/₄"')

⊖ = 7154 ⚙ = 7185

Tank locomotive

3000

Tank locomotive · Model of the 0-6-0 class 89 locomotive · 3 driven axles · 2 non-skid tires · Remote control for forward and reverse drive · Three working headlights · Mat black body · Die cast zinc frame · Coupling hooks at each end · Length over buffers 11 cm (4³/₈"')

Many people favor these double end locomotives because of the many uses to which they can be put in passenger and freight train service, especially for work in switching yards, and for their design and the ease with which they can be put on the track. Their ability to stay on curves at high speed and to pull heavy loads and their attractive appearance are special advantages of these locomotives.

⊖ = 7154 ⚙ = 7185 ⚙ = 60010



"BR 74" A very desirable Märklin model

3095

Tank locomotive · A model of the German Federal Railways 2-6-0 class 74 locomotive · 3 driven axles · 2 non-skid tires · Simulated Heusinger reversing gear · Remote control for forward and reverse drive · Three working headlights · Mat black body · Die cast zinc frame · Coupling hook with advance uncoupler at the front, automatic coupling with advance uncoupler (RELEX) at rear · Length over buffers 13.5 cm (5³/₁₆"')

The first of these superheated steam tank locomotives was put into service by the Royal Berlin Railways in 1902. It proved so successful that hundreds of the same type were working untiringly on suburban passenger services until the 1920's, when the Berlin city and circle line

was electrified. Over the years nearly 1000 of these very reliable machines were built. When they were no longer required in Berlin, other railroad centers took them over for use on local passenger services and for switching operations. Their length was 11.80-12 m (38 ft. 8³/₁₆"')

was 39 ft. 4⁷/₁₆"'). With a working weight of 70 tons they could reach a speed of 80 km/h (50 mph) either forwards or backwards.

⊖ = 7153 ⚙ = 7185 ⚙ = 60010

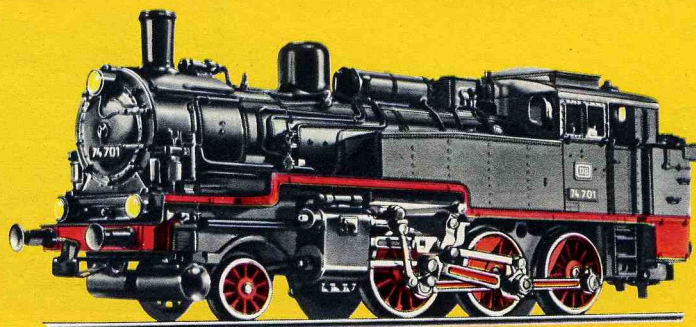

"BR 86" standard locomotive
used on the German
Federal Railways,
with Märklin
TELEX coupling

3096

Tank locomotive · A model of the German Federal Railways 2-8-2 class 86 locomotive · 4 driven axles · 2 non-skid tires · Simulated Heusinger reversing gear · Remote control for forward and reverse drive · 3 working headlights at each end · Outstandingly detailed black body with many fittings · Die cast zinc frame · **Märklin TELEX coupling** at each end · Length over buffers 15.8 cm (6¹/₄")

⊙ = 7153 ⊞ = 7164 ⊕ = 60015

8396

The same model as 3096, but arranged for 2 rail direct current (DC) operation

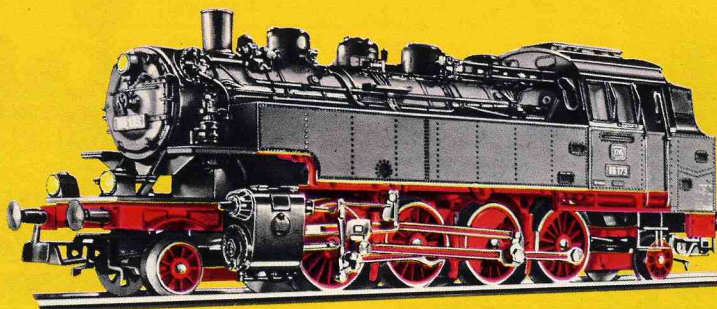

The Märklin **TELEX coupling** enables the attached train to be uncoupled at any point on the track, by remote control from the transformer. Trains can also be coupled-up at any desired point, again using the automatic coupling. No extra equipment is required. The following locomotives are equipped with Märklin TELEX couplings: 3096 and 3065 (see page 28).

The standard class 86 locomotive, which was developed for mixed service on branch lines with a high traffic-density, achieved the respectable representation of 774 machines in the stocks of the former German State Railways. The German Federal Railways acquired 385 of these,

which have since been taken out of service. Some machines were equipped with Krauss-Helmholtz frames, enabling the speed to be raised from the original 70 to 80 km/h (44 to 50 mph). The locomotive is 13.82 m (45 ft. 4¹/₂") long. At the working weight of 88.5 tons the maximum axle load is 15.6 tons.

Mixed traffic locomotive

3003

Passenger locomotive with tender · A model of the German Federal Railways 2-6-0 class 24 locomotive · 3 driven axles · 2 non-skid tires · Simulated Heusinger reversing gear · Remote control for forward and reverse drive · 3 working headlights · Mat black body · Die cast zinc frame · Coupling hook in front · Automatic coupling with advance uncoupler (RELEX) on the tender · Length over buffers 20 cm (7⁷/₈")

⊙ = 7153 ⊞ = 7185 ⊕ = 60010

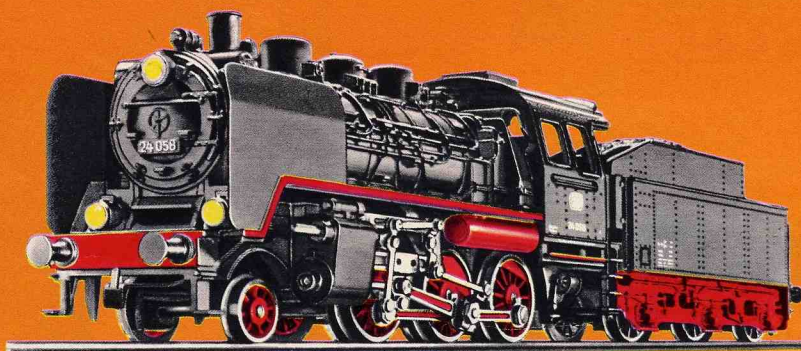

The standard class 24 locomotive was used on German Federal Railways for local passenger and freight services. Its maximum speed was 90 km/h (56 mph).

Locomotive with tender
"BR 38"

3099

Locomotive with tender · A model of the former German State Railways' 4-6-0 class 38 locomotive · 3 driven axles · 2 non-skid tires · Simulated Heusinger reversing gear · Remote control for forward and reverse drive · 3 working headlights · Mat black metal body with large smoke deflector plates and detailed representation of the fittings on the boiler and in the driver's cab · Die cast zinc frame · 4-axled tender · Coupling hook in front, automatic coupling with advance uncoupler (RELEX) on the tender · Length over buffers 21.8 cm (8¹/₂") · Figures of the driver and the fireman are included

⊙ = 7152 ⊞ = 7185 ⊕ = 60015

8399

The same model as 3099, but arranged for 2 rail direct current (DC) operation

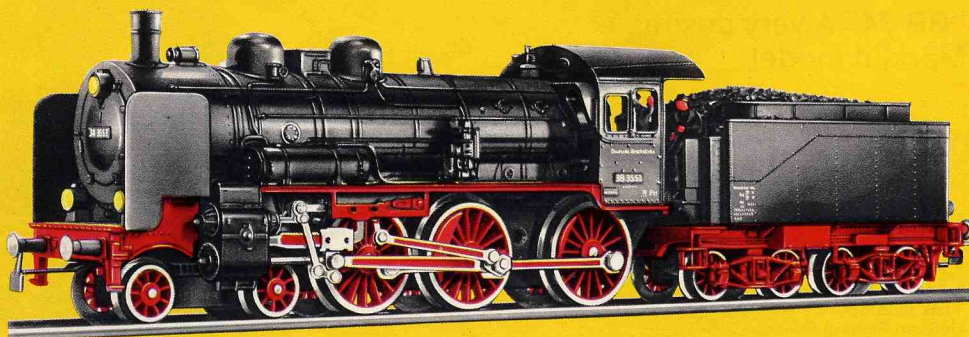

The P8 family of passenger train locomotives, which started with the machines built for the Prussian State Railways in 1906, by order of the Berlin Railway Administration under its director, Garbe, proved to be one of Germany's most fortunate locomotive designs. This locomotive, with its superior performance for those days and its low running costs, became very popular. 3370 machines were supplied to Prussia alone. For the first time in a major series-produced locomotive, the Schmidt

smoke tube superheater was used and with outstanding success. When the German State Railway Company was formed, the P8 was re-designated class 38, and was put into service not only throughout Germany but also abroad. Locomotives of this type were still to be seen in southern Germany until a few years ago, frequently on express services. They could be recognised by the unusual wheel arrangement, with the third driving axle displaced to the rear.

Steam locomotives

Express locomotive with tender "S 3/6"

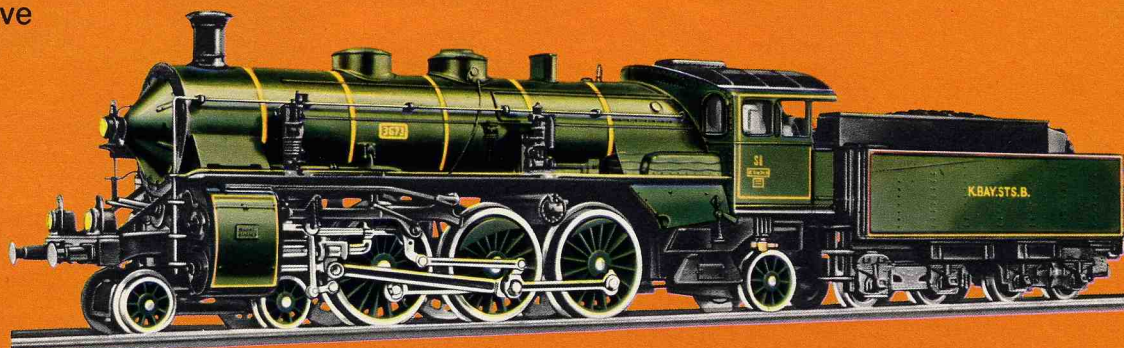

3092

Express locomotive with tender · A model of the former Royal Bavarian Railways 4-6-2 class S 3/6 series i locomotive · 3 driven axles · 2 non-skid tires · Simulated Heusinger reversing gear · Remote control for forward and reverse drive · 3 working headlights · Dark green metal body with yellow boiler hoops · Fairing at

the driver's cab · Fittings accurately detailed · Die cast zinc frame · Automatic coupling with advance uncoupler (RELEX) on the tender · Length over buffers 24.9 cm (9³/₄"') · **This locomotive can be fitted with the smoke set 7227 (see page 55)**

⊖ = 7152 ⊞ = 7185 ⊕ = 60015

8392

The same model as 3092, but arranged for 2 rail direct current (DC) operation

"BR 18" express locomotive

3093

Express locomotive with tender · A model of the German Federal Railways 4-6-2 class 18^a locomotive (Bavarian class S 3/6, series i) · 3 driven axles · 2 non-skid tires · Simulated Heusinger reversing gear · Remote control for forward and reverse drive · 3 working headlights · Mat black metal body · Fittings very finely detailed · Die cast zinc frame · Automatic coupling with advance uncoupler (RELEX) on the tender · Length over buffers 24.9 cm (9³/₄"') · **This locomotive can be fitted with the smoke set 7227 (see page 55)**

⊖ = 7152 ⊞ = 7185 ⊕ = 60015

8393

The same model as 3093, but arranged for 2 rail direct current (DC) operation

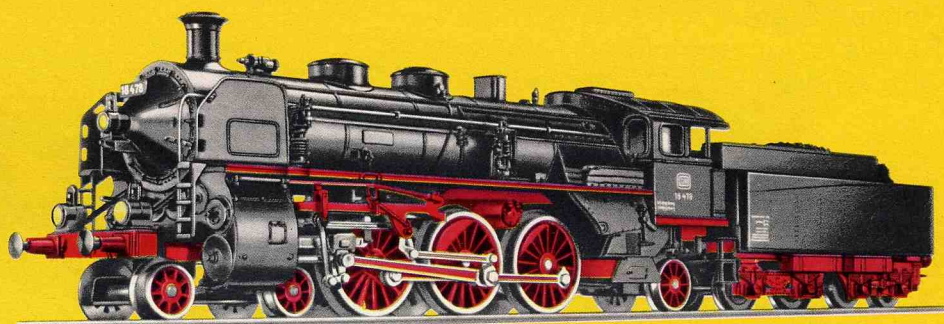

Connoisseurs regard the Bavarian class S 3/6 locomotive, with its powerful cylinder group, clearly arranged underframe, streamlining and characteristic rimmed smoke stack, as the finest steam locomotive of all. The S 3/6s, later re-designated class 18^a by the German State Railways, were often used to pull international expresses, including the famous "Rhein-

gold", not only because of their appearance but also because of their excellent performance. They reached a maximum speed of 120 km/h (75 mph) at a working weight of 92.3 tons. Their length over the buffers was 21.22 m (69 ft. 7⁷/₁₆"'). The last machine of this type, No. 18478, was taken out of service in July, 1960.

French express locomotive

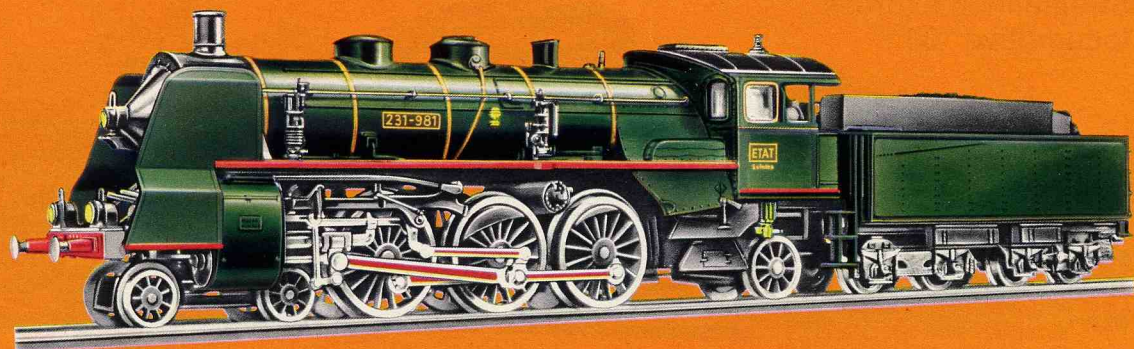

3083

Express locomotive with tender · A model of the former French State Railways 4-6-2 class 231 locomotive · 3 driven axles · 2 non-skid tires · Simulated Heusinger reversing gear · Remote control for forward and reverse drive · 3 working

headlights · Green and black metal body · Bronze-colored boiler hoops · Smoke deflector plates · Finely detailed fittings · Die cast zinc frame · Automatic coupling with advance uncoupler (RELEX) on the tender · Length over buffers

25.5 cm (9¹³/₁₆"') · **This locomotive can be fitted with the smoke set 7227 (see page 55)**

⊖ = 7152 ⊞ = 7185 ⊕ = 60015



Belgian State
Railways' locomotive
with tender

3086

Locomotive with tender · A model of the Belgian State Railways (NMBS/SNCB) 4-6-0 class 64 locomotive · 3 driven axles · 2 non-skid tires · Simulated Heusinger reversing gear · Remote control for forward and reverse drive · 3 working headlights · Green metal body, bronze-colored boiler hoops and external piping · Die cast zinc frame · Coupling hook in front, automatic coupling with advance uncoupler (RELEX) on the tender · Length over buffers 21.8 cm (8½")

⊙ = 7152 ⊞ = 7185 ⊚ = 60015

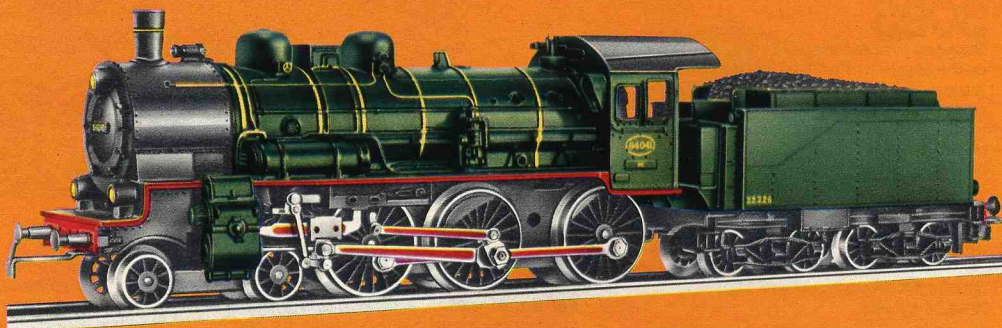

Streamlined express
locomotive "03¹⁰"

3089

Streamlined express locomotive with tender · A model of the 4-6-2 class 03¹⁰ locomotive · 3 driven axles · 2 non-skid tires · Simulated Heusinger reversing gear · Remote control for forward and reverse drive · 2 working headlights · Dark red streamlined metal body with silver stripes · Black smoke deflector plates · Detailed simulation of fittings on boiler and in driver's cab · Die cast zinc frame · Automatic coupling with advance uncoupler (RELEX) on the tender · Length over buffers 27.4 cm (10¾")

⊙ = 7152 ⊞ = 7185 ⊚ = 60015

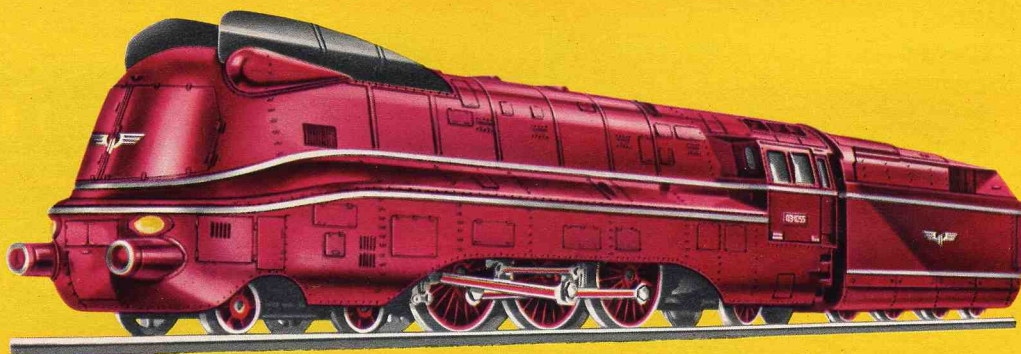

In 1937, after the value of streamlined fairings in reducing drag at high speeds had been proved on other locomotives, the three-cylinder class 03¹⁰ with streamlined fairings was put into service. For easier maintenance, however, the driving

gear was left uncovered. The locomotive was developed as a lighter version of the class 01, and originally had an axle load of 17 tons and a maximum speed of 140 km/h (85 mph).

Steam locomotives

Freight train locomotive "BR 041"

3082 **new**

Freight train locomotive with tender · A model of the German Federal Railways' 2-8-2 class 041 locomotive · 4 axles driven through concealed gears · 2 non-skid tires · Simulated Heusinger reversing gear · Remote control for forward and reverse drive · Three working headlights · Mat black body in very fine detail · Die cast zinc frame · Coupling hook in front, automatic coupling with advance uncoupler (RELEX) on the tender · Length over buffers 27.5 cm (10³/₄"') · **This locomotive can be fitted with smoke set 7226 (see page 55)**

⊖ = 7153 ⊞ = 7164 ⊕ = 60015

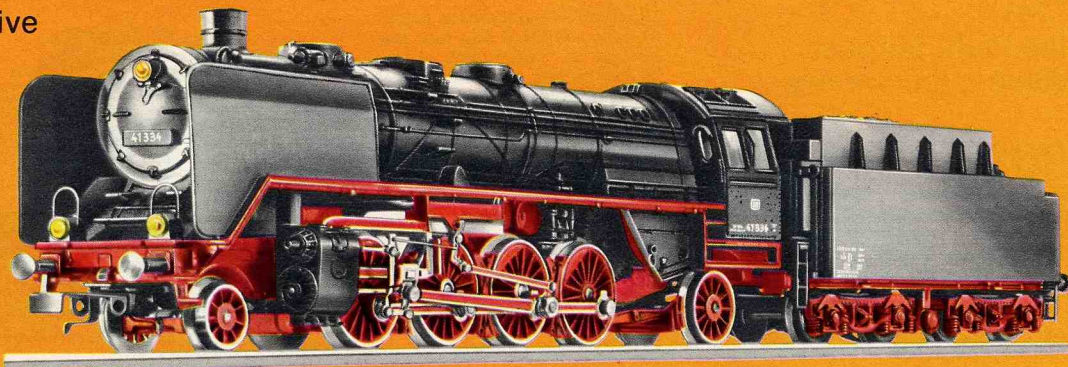

8382 **new**

The same model as 3082, but arranged for 2 rail direct current (DC) operation

The former German State Railways planned to use class 41 locomotives to pull high speed freight trains, but these machines proved in service to be ideal general purpose locomotives for any medium-weight trains. The first class 41 was delivered in 1936 by the firm of

Schwartzkopff. With a power of 1400 kW its maximum speed was 90 km/h (56 mph). The boiler was the same as the very successful type used in the class 03 locomotive. Most German locomotive manufacturers shared in the production of a total of 366 locomotives of this type.

Heavy freight locomotive with cab tender

3084

Heavy freight locomotive with cab tender · A model of the German Federal Railways 2-10-0 class 050 locomotive · 5 axles driven by concealed gears · 4 non-skid tires · To give easy running on curves, the frame is divided into two groups of driving wheels, flexibly coupled together · Simulated Heusinger revers-

ing gear · Remote control for forward and reverse drive · 3 working headlights · Mat black body in finest detail · Die cast zinc frame · Coupling hook in front, automatic coupling with advance uncoupler (RELEX) on the tender · Length over buffers 26.1 cm (10¹/₄"') · **This locomotive can be fitted with**

the smoke set 7226 (see page 55)

⊖ = 7153 ⊞ = 7164 ⊕ = 60015

Because of its low axle load of 15 tons, this freight locomotive, now known as class 050, can also be used on light railroads. Most European locomotive manufacturers shared in the building of over 3000

of these machines. In the sixties, most of the locomotives still in service had a driver's cab incorporated in the tender, making them even more versatile. Maximum speed is 80 km/h (50 mph), at which the machine develops 1200 kW. Length over buffers 22.94 m (75 ft. 3¹/₈"').

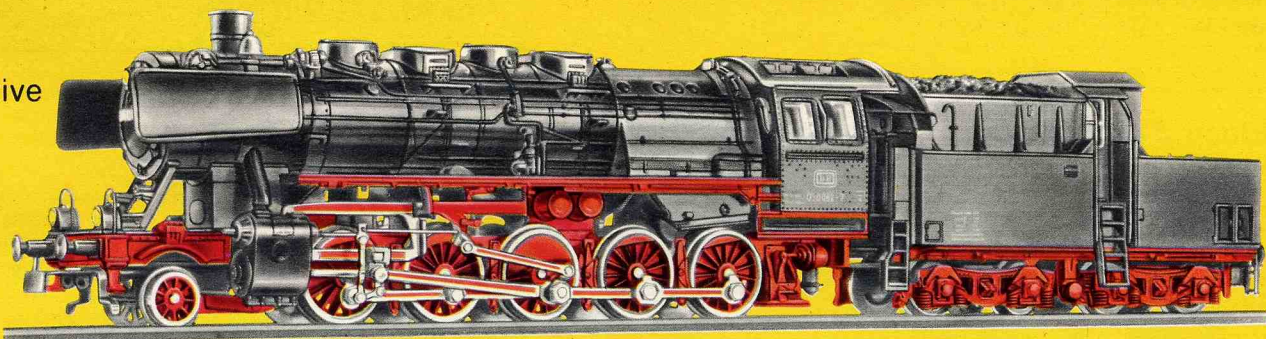

German Federal Railways' express locomotive "BR 003"

3085

Express locomotive with tender · A model of the German Federal Railways 4-6-2 class 003 locomotive · 3 axles driven by concealed gears · 2 non-skid tires · Simulated Heusinger reversing gear · Remote control for forward and reverse drive · 3 working headlights · Mat black body in very fine detail ·

Die cast zinc frame · Automatic coupling with advance uncoupler (RELEX) on tender · Length over buffers 27.7 cm (11"') · **This locomotive can be fitted with the smoke set 7226 (see page 55)**

⊖ = 7152 ⊞ = 7164 ⊕ = 60015

8385

The same model as 3085, but arranged for 2 rail direct current (DC) operation

The former German State Railways used about 300 class 03 (now known as class 003) locomotives, a lighter

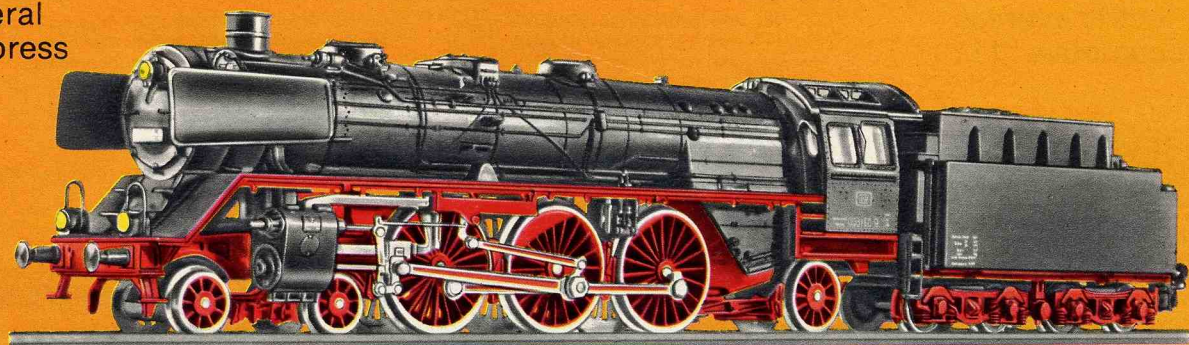

version of the class 01, for pulling express trains on track sections where an axle load as high as 20 tons was not permitted. They developed 1450 kW giving a maximum speed of 130 km/h (80 mph). Coupled to the T32 tender the overall length over the buffers was 23.90 m (78 ft. 5"').



"141" the multi purpose electric locomotive



3034

Electric locomotive · A model of the German Federal Railways B-B class 141 locomotive · 2 driven axles · 4 non-skid tires · Remote control for forward and reverse drive · 3 working headlights at each end · Lever for selecting operation by overhead line or track supply · 2 spring-loaded pantographs on roof · Turquoise and beige metal body · Windows inset in plastic frames · Coupling hook with advance uncoupler at each end · Length over buffers 17.5 cm (7")

0 = 7153  = 7164  = 60015

3037

Electric locomotive · A model of the German Federal Railways class 141 locomotive · Similar to 3034, except that the body is green

0 = 7153  = 7164  = 60015



The class 141 locomotive has a working weight of 66.4 tons and a length of 15.66 m (51 ft. 4 1/2"). Its four motors are rated at a total of 2280 kW continuous. The maximum speed is 120 km/h (74.5 mph). The locomotive is used for passenger and freight services.



Electric express locomotive "110"

3039

Electric express locomotive · A model of the German Federal Railways B-B class 110 locomotive · 2 driven axles · 4 non-skid tires · Remote control for forward and reverse drive · 3 working headlights at each end · Lever for selecting operation by overhead line or track supply · Blue metal body · Outstanding reproduction of all roof details · 2 spring-loaded pantographs on roof · Silver colored roof · Windows inset in plastic frames · Coupling hook with advance uncoupler at each end · Length over buffers 18.1 cm (7 1/8")

0 = 7153  = 7164  = 60015

The class 110 electric locomotives were purchased by the German Federal Railways from 1956 onward. The 110 is used as an express locomotive, with a maximum permitted speed of 150 km/h (93 mph).



The class 110 locomotive has 4 motors giving a total of about 3620 kW. The locomotive weighs 85 tons and its length over the buffers is 16.44 m (53 ft. 11 1/4").



Electric express locomotive "111"

3042

Electric express locomotive · A model of the German Federal Railways B-B class 111 locomotive · 2 driven axles · 4 non-skid tires · Remote control for forward and reverse drive · 3 working headlights at each end · Lever for selecting operation by overhead line or track supply · Turquoise and beige body · Windows inset in plastic frames · 2 spring-loaded pantographs on roof · Die cast zinc frame · Automatic coupling with advance uncoupler (RELEX) at each end · Length over buffers 19.1 cm (7 1/2")

0 = 7153  = 7164  = 60015

The first locomotives of the new class 111, which is a further development of the well proved class 110, have been in service with German Federal Railways since the end of December 1974. With this locomotive emphasis has been placed not so much on increasing the power as on optimizing the engine driv-

er's cab layout, reducing track loading and increasing running safety. The maximum permitted speed of this locomotive, which is 16.75 m (54 ft. 10") long and weighs 83 tons, is 150 km/h (93 mph). It can be equipped either with pantographs or single bar current collectors.



8342 **new**

The same model as 3042, but arranged for 2 rail direct current (DC) operation

Electric locomotives

Electric switching locomotive "EA 800"

The locomotives of this type were built for heavy track and switching service on works' rail systems, and for transferring rolling stock to the mainline railroads. They can draw current either from overhead lines or from internal batteries. Their maximum speed is 50 km/h (31 mph). The locomotive develops a starting tractive force of 19 500 kg with single-axle drive. Its weight is 60 tons and its length 10.20 m (33 ft. 5 1/2").

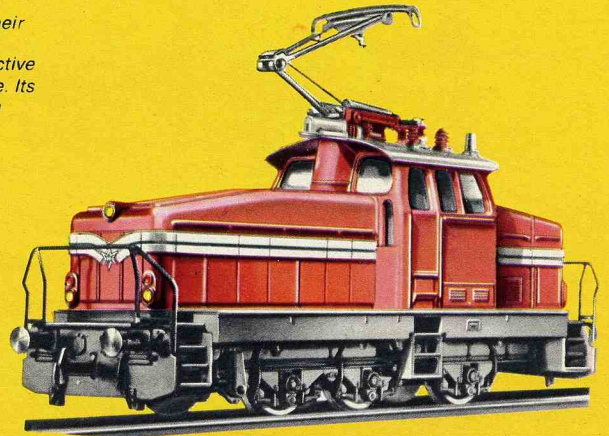

3044

Electric locomotive · A model of the 0-6-0 Type EA 800 multi system industrial locomotive · 3 driven axles · 2 non-skid tires · Remote control for forward and reverse drive · Lever for selecting operation by overhead line or track supply · 3 working headlights at each end · Red body · Single bar current collector on roof · Die cast zinc frame · Finely detailed axle box covers · Coupling hook at each end · Length over buffers 11.2 cm (4 3/8")

⊙ = 7154 ⊞ = 7185 ⚡ = 60015

"194" heavy electric freight locomotive

3022

Electric freight locomotive · A model of the German Federal Railways' C-C class 194 locomotive · 3 driven axles · 4 non-skid tires · Remote control for forward and reverse drive · 3 working headlights at each end · Lever for selecting operation by overhead line or track supply · 2 spring-loaded pantographs on roof · Green three-section metal body · Silver-colored roof · Windows inset in plastic frames · Automatic coupling with advance uncoupler (RELEX) at each end · Length over buffers 21 cm (8 1/4")

⊙ = 7153 ⊞ = 7164 ⚡ = 60015

8322

The same model as 3022, but arranged for 2 rail direct current (DC) operation



The class 194 locomotive is a heavy-weight. The 6 motors give it a starting power of about 4670 kW. With a total weight of 120 tons the machine has a maximum starting tractive force of 40

tons. Although its maximum speed is only 90 km/h (56 mph), it is perfectly capable of tackling any gradient, even with the heaviest freight train. 124 of these 18.60 m (61 ft. 3") long giants are in service with the German Federal Railways.

French high power electric locomotive

3038

Electric locomotive · A model of the Société Nationale des Chemins de Fer Français (SNCF) B-B class BB 9200 locomotive · 2 driven axles · 4 non-skid tires · Remote control for forward and reverse drive · 2 working headlights at each end · Lever for selecting operation by overhead line or track supply · 2 spring-loaded pantographs on roof · Turquoise metal body · Coupling hook with advance uncoupler at each end · Length over buffers 18 cm (7 1/16")

⊙ = 7153 ⊞ = 7164 ⚡ = 60015

The French original of our model 3038 runs on certain stretches of the French Railways at a maximum speed of 160 km/h (100 mph). The class BB 9200 locomotives have 4 motors developing a total of 4050 kW, hourly rating. Their weight is 80 tons.



Italian electric locomotive

3035

Electric locomotive · A model of the Italian State Railways' (FS) B-B class E 424 locomotive · 2 driven axles · 4 non-skid tires · Remote control for forward and reverse drive · 2 working headlights at each end · Lever for selecting operation by overhead line or track supply · 2 spring-loaded pantographs on roof · Brown metal body · Coupling hook with advance uncoupler at each end · Length over buffers 17.5 cm (6⁷/₈"')

⊙ = 7153 ⊞ = 7164 ⊚ = 60015



Austrian Federal Railways' multi-purpose locomotive

3041

Multi-purpose electric locomotive · A model of the Austrian Federal Railways' (ÖBB) B-B class 1043 locomotive · 2 driven axles · 4 non-skid tires · Remote control for forward and reverse drive · 3 working headlights at each end · Lever for selecting operation by overhead line or track supply · Red body · Windows inset in plastic frames · 2 single-bar current collectors on roof · Die cast zinc frame · Coupling hook at each end · Length over buffers 17.5 cm (6⁷/₈"')

⊙ = 7153 ⊞ = 7164 ⊚ = 60015



After extensive trials with this locomotive, which was built by the Swedish firm ASEA, the Austrian Federal Railways acquired four of them initially and put them into service with the class designation 1043. The 16²/₃ Hz alternating current supply

from the overhead line is converted to direct current by means of thyristors. The four motors develop almost 3680 kW, enabling the 77.4 ton, 15.5 m (50 ft. 10¹/₄"') long locomotive to reach a maximum speed of 135 km/h (84 mph).

Netherlands Railways' electric locomotive

3055

Electric locomotive · A model of the Netherlands Railways' (NS) C-C class 1200 locomotive · 3 driven axles · 4 non-skid tires · Remote control for forward and reverse drive · 3 working headlights at each end · Lever for selecting operation by overhead line or track supply · Gray and yellow metal body · 2 spring-loaded pantographs on roof · Windows inset in plastic frames · Coupling hook at each end · Length over buffers 19.6 cm (7³/₄"')

⊙ = 7154 ⊞ = 7164 ⊚ = 60015



The catenary system adds realism to the operation of the railroad

Swedish electric locomotive

3030

Electric locomotive · A model of the Swedish State Railways' (SJ) 2-8-2 class Da locomotive · 3 driven axles · Jackshaft driven through gears · 2 non-skid tires · Remote control for forward and reverse drive · 3 working headlights at each end · Lever for selecting operation by overhead line or track supply · 2 spring loaded pantographs on roof · Brown metal body · Die cast zinc frame · Automatic coupling with advance uncoupler (RELEX) at each end · Length over buffers 14.7 cm (5³/₄"')

⊕ = 7153 ⊞ = 7185 ⊚ = 60015



The class Da is used on Swedish State Railways (Statens Järnvägar) as the standard electric locomotive for passenger and freight service. Since these machines have

only one motor and the low axle loading of 15 or 17 tons, they are fitted with main driving rods so that individual wheels do not "run away" on starting.

Interesting Swedish multi-purpose locomotive

3043

Electric multi-purpose locomotive · A model of the Swedish State Railways' (SJ) B-B class Rc locomotive · 2 driven axles · 4 non-skid tires · Remote control for forward and reverse drive · 4 working headlights at each end · Lever for selecting operation by overhead line or track supply · Orange body · Windows inset in plastic frames · 2 spring-loaded pantographs on roof · Die cast zinc frame · Coupling hook at each end · Length over buffers 17.5 cm (6⁷/₈"')

⊕ = 7153 ⊞ = 7164 ⊚ = 60015



In these machines of very advanced design, the 16²/₃ Hz alternating current supply from the overhead line is converted by thyristors into direct current, which drives the four motors, developing a power

of almost 3680 kW. The machine weighs 76 tons and can reach a speed of 135 km/h (84 mph). It is almost 15.50 m (50 ft. 10¹/₄"')

The Swiss Federal Railways' powerful multi-purpose locomotive

3050

Multi-purpose electric locomotive · A model of the Swiss Federal Railways' (SBB) C-C class Ae6/6 locomotive · 3 driven axles · 4 non-skid tires · Remote control for forward and reverse drive · 3 working headlights at each end · Lever for selecting operation by overhead line or track supply · 2 spring-loaded pantographs on roof · Green metal body · Silver-colored roof · Locomotive has the crest of Berne Canton · Coupling hook at each end · Length over buffers 20 cm (7⁷/₈"')

⊕ = 7153 ⊞ = 7164 ⊚ = 60015



The Swiss Federal Railways ordered the class Ae6/6 for international passenger and freight express service. The locomotive's 120 tons weight and 4400 kW from six motors give it enormous

starting and climbing power. The maximum speed is 125 km/h (78 mph). For all its brute force, it is of particularly stylish appearance. That's why we have made an exact copy of it.

Express locomotive "103"

This is the strongest, fastest and most elegant electric express train in service with German Federal Railways at this time. It is 19.50 m (63 ft. 11³/₄"') long and has 6 motors driving 6 axles. With its almost 6600 kW hourly rating, its working weight of 112 tons and its mighty tractive force on

starting of 32 000 kg, it caters for future requirements. On suitable tracks, expresses pulled by the "103" travel at maximum speeds of 200 km/h (125 mph). All the splendid features of the original are captured in the small Märklin model.

3054

Electric express locomotive · A model of the German Federal Railways' C-C class 103 locomotive · 3 driven axles · 4 non-skid tires · Remote control for forward and reverse drive · 3 working headlights at each end · Lever for selecting operation by overhead line or track supply · Die cast zinc frame · Specially low center of gravity · Body in the TEE colors, beige and red · Aluminum-colored roof · Windows inset in plastic frames · 2 spring-loaded pantographs on roof · Coupling hook at each end · Length over buffers 21.9 cm (8⁵/₈"')

⊙ = 7153 ⊞ = 7164 ⊚ = 60015



Freight locomotive "151"

3057

Electric freight locomotive · A model of the German Federal Railways' C-C class 151 locomotive · 3 driven axles · 4 non-skid tires · Remote control for forward and reverse drive · 3 working headlights at each end · Lever for selecting operation by overhead line or track supply · Dummy interior fittings · Die cast zinc frame, permitting a favorable center of gravity position · Green body · Windows inset in plastic frames · 2 spring-loaded pantographs on roof · Coupling hook at each end · Length over buffers 22.2 cm (8³/₄"')

⊙ = 7153 ⊞ = 7164 ⊚ = 60015

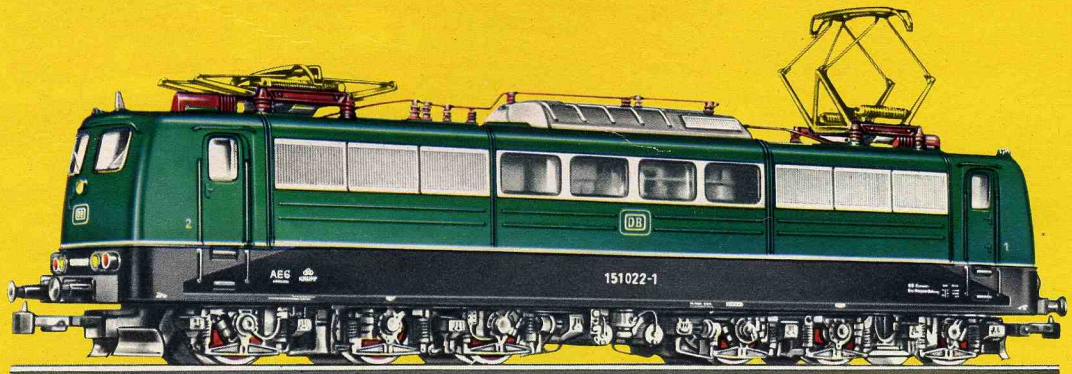

Freight locomotive "151"

3058

Electric freight locomotive · A model of the German Federal Railways' class 151 locomotive · Similar to 3057, but with a turquoise and beige body

⊙ = 7153 ⊞ = 7164 ⊚ = 60015

The development of a new heavy freight locomotive became necessary as the speeds of express freight trains rose to 120 km/h (75 mph). By using well proved components from other locomotives it was possible to produce a new and very powerful machine within a short time. The new locomotive, which has a working weight of

only 118 tons, develops a starting tractive force of 45 tons, and with its 6 motors developing a total of 6540 kW continuous rating it can pull a train weighing 1000 tons on the level at a speed of 120 km/h (75 mph). The class 151 locomotives are 19.49 m (63 ft. 11⁵/₈"') long.

8358

The same model as 3058, but arranged for 2 rail direct current (DC) operation



The catenary system providing the power to operate two trains on one track

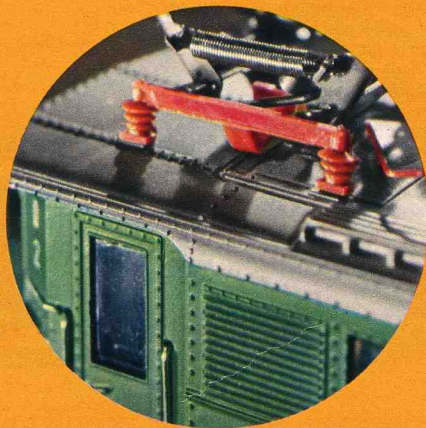
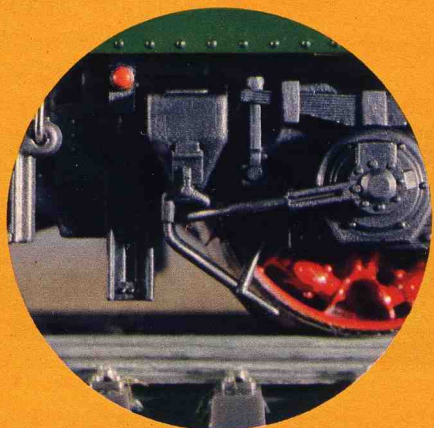

Express locomotive "104"

3049 **new**

Electric express locomotive · A model of the German Federal Railways' 2-6-2 class 104 locomotive · 3 driven axles · 2 non-skid tires · 2 sprung trucks · Remote control for forward and reverse drive · 3 working headlights at each end · Lever for selecting operation by overhead line or track supply · Die cast zinc frame · Green body · Inset windows · 2 spring-loaded pantographs on roof · Coupling hook at each end · Length over buffers 17.8 cm (7")

⊗ = 7153 ⊞ = 7185 ⊕ = 60015

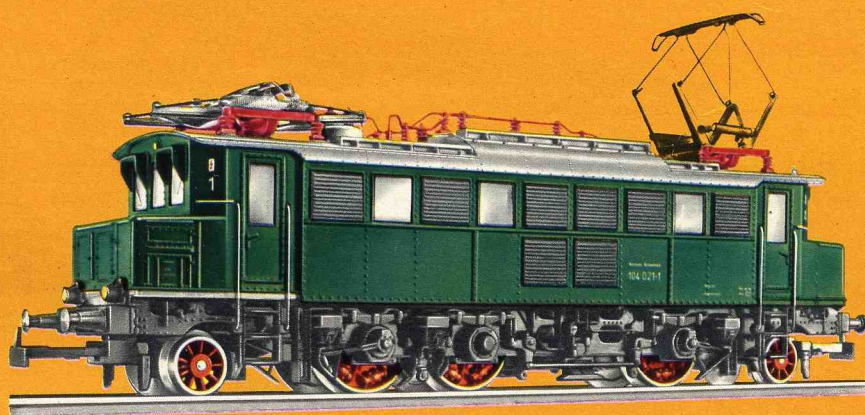

Of the 23 original class 04 machines, only locomotives 17-22 were transferred to German Federal Railways. They have been operating since 1968 under the

number 104017-104022 and are now in process of being withdrawn from Federal Railways service.

Swiss heavy freight locomotive "Crocodile"

3056

Electric freight locomotive · A model of the Swiss Federal Railways' (SBB) 1C-C1 class Be6/8" locomotive "Crocodile" · 3 driven axles · 4 non-skid tires · Because of its articulated construction it can easily negotiate curves of normal radius · Remote control for forward and reverse drive · 3 working headlights at each end · Lever for selecting operation by overhead line or track supply · 2 spring-loaded pantographs on roof · Green body · Windows inset in plastic frames · Automatic coupling with advance uncoupler (RELEX) at each end · Length over buffers 22.8 cm (9")

⊗ = 7153 ⊞ = 7164 ⊕ = 60015

8356

The same model as 3056, but arranged for 2 rail direct current (DC) operation

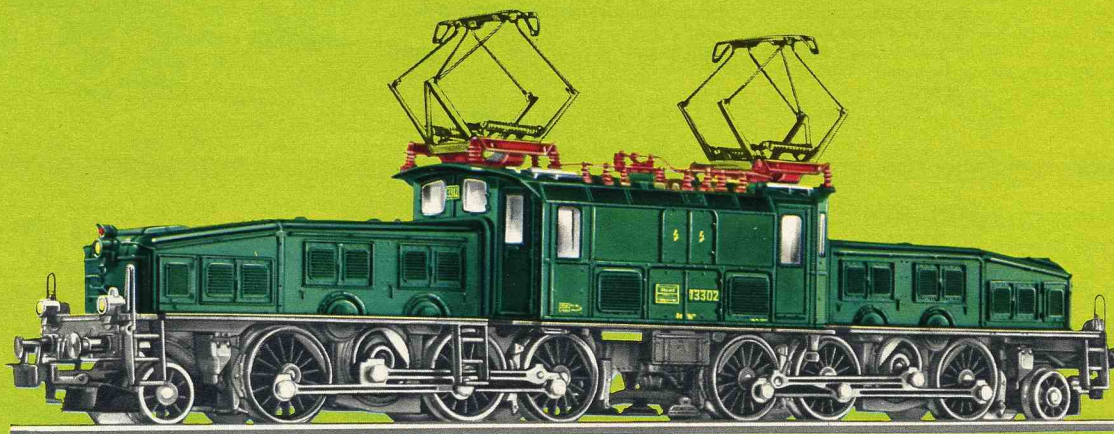

As a result of the growth in traffic density on the Gotthard route, another 18 locomotives designated Be6/8" were put into service in 1926 and 1927. Like the class Ce 6/8 machines already in service, they became well-known under the nickname of "Crocodile" far beyond the frontiers of

Switzerland. With a length of 20.06 m (65 ft. 9 3/4") and a motor power of 1800 kW, giving a maximum speed of 75 km/h (47 mph), they were for many years one of the most impressive sights in the Swiss heavy freight train service.

Diesel-hydraulic locomotive "DHG 500"

3078

Diesel locomotive · A model of the 0-6-0 industrial locomotive known as the Type DHG 500 · 3 driven axles · 2 non-skid tires · Remote control for forward and reverse drive · 3 working headlights at each end · Blue body with decorative silver-colored bands · Die cast zinc frame · Coupling hook at each end · Length over buffers 11.2 cm (4³/₈")

⊙ = 7154 🚞 = 7185 ♀ = 60015

These "small" diesel locomotives with hydraulic transmissions are in fact at least 10-11 m (32 ft. 10" -36 ft. 1") long and they have a power of several hundred kW under the hood. In particular, the heavily loaded transmissions are especially robust, so that these locomotives can be used for quite long periods without too much maintenance. The Märklin models 3078 and 3080, which are typical industrial locomotives, have windows in the lower corners of the front panel of the cab, which enable the driver to have a clear view of the buffers and to position the locomotive accurately in switching operations.



Industrial locomotive

3080

Diesel locomotive · A model of a 0-6-0 industrial locomotive · 3 driven axles · 2 non-skid tires · Remote control for forward and reverse drive · Yellow body with dark decorative bands · Die cast zinc frame · Coupling hook at each end · Length over buffers 11.2 cm (4³/₈")

⊙ = 7154 🚞 = 7185



Diesel-hydraulic switching locomotive "260" with Märklin TELEX coupling

3065

TELEX see page 18

Diesel locomotive · A model of the German Federal Railways 0-6-0 class 260 locomotive · 3 driven axles · 2 non-skid tires · Remote control for forward and reverse drive · 3 working headlights at each end · Red body · Windows inset in plastic frames · Die cast zinc frame · Märklin TELEX coupling at each end · Length over buffers 12 cm (4³/₄")

⊙ = 7153 🚞 = 7185 ♀ = 60010

with coupling hooks

3064

Diesel locomotive · A model of the German Federal Railways' class 260 locomotive · Similar to 3065, but **without** the Märklin TELEX coupling · Coupling hook with advance uncoupler at each end

⊙ = 7153 🚞 = 7185 ♀ = 60010



Diesel-hydraulic locomotive "212"

3072

Diesel locomotive · A model of the German Federal Railways' B-B class 212 locomotive · 2 driven axles · 4 non-skid tires · Remote control for forward and reverse drive · 3 working headlights at each end · Die cast zinc frame · Red body · Narrow front and rear ends to scale · Windows inset in plastic frames · Automatic coupling with advance uncoupler (RELEX) at each end · Length over buffers 14.1 cm (5¹/₂") · A suitable positioning of the motor in model 3072 has enabled the front and rear end super-structure to be kept narrow as on the original

⊙ = 7154 🚞 = 7164 ♀ = 60010

The 212 is a multi-purpose diesel locomotive with a working weight of 63.2 tons and a length of over 12 m (39 ft. 4"). The new types develop about 1000 kW, and this power is transmitted by means of cardan shafts to the 4 axles arranged in 2 trucks.



To suit the tractive force of the powerful motor to the requirements of passenger and freight traffic, a two-speed gearbox is used. The gear ratio must be selected when the lo-



comotive is stationary. In low gear the locomotive exerts its maximum tractive force, but has a maximum speed of only 65 km/h (40 mph), while in high gear it reaches 100 km/h (62 mph).

Diesel locomotives

Diesel-hydraulic express locomotive "220"

3021

Diesel locomotive · A model of the German Federal Railways' B-B class 220 locomotive · 2 driven axles · 4 non-skid tires · Remote control for forward and reverse drive · 3 working headlights at each end · Red and gray metal body · Silvery-gray roof · Coupling hook with advance uncoupler at each end · Length over buffers 21 cm (8 1/4")



0 = 7154  = 7183  = 60010



Diesel locomotive "216"

3074

Diesel locomotive · A model of the German Federal Railways' B-B class 216 locomotive · 2 driven axles · 4 non-skid tires · Remote control for forward and reverse drive · 3 working headlights at each end · Turquoise and beige body · Windows inset in plastic frames and with simulated windshield wipers · Die cast zinc frame · Automatic coupling with advance uncoupler (RELEX) at each end · Length over buffers 18.2 cm (7 1/8")

0 = 7154  = 7164  = 60015

8374

The same model as 3074, but arranged for 2 rail direct current (DC) operation

3075

Diesel locomotive · A model of the German Federal Railways' class 216 locomotive · Similar to 3074, but with a red and gray body

0 = 7154  = 7164  = 60015

8375

The same model as 3075, but arranged for 2 rail direct current (DC) operation





The class 216 diesel locomotive is used for mainline duty over medium distances. The working weight with full fuel tanks is 79 tons. It develops a power of 1400 kW, giving a maximum speed of 120 km/h (75 mph).



Belgian State Railways' multi-purpose diesel locomotive

3066

Diesel locomotive · A model of the Belgian State Railways' (NMBS/SNCB) C-C Type 204 locomotive · 3 driven axles · 4 non-skid tires · Remote control for forward and reverse drive · 3 working headlights at each end · Green metal body · Black roof · Windows inset in plastic frames · Coupling hook at each end · Length over buffers 20.5 cm (8")

0 = 7154  = 7164  = 60015



The Belgian multi-purpose diesel locomotive type 204 has diesel-electric drive. It is used for local and express passenger trains, and its power of 1300 kW gives it a maximum speed of 140 km/h (87 mph).

Danish State Railways' diesel-electric locomotive



3067

Diesel locomotive · A model of the Danish State Railways' (DSB) A1A-A1A Type My 1100 locomotive · 3 driven axles · 4 non-skid tires · Remote control for forward and reverse drive · 3 working headlights at each end · Black and red metal body · Gray roof · Windows inset in plastic frames · Coupling hook at each end · Length over buffers 20.5 cm (8")

⊙ = 7154 🚂 = 7164 🔦 = 60015

These Danish State Railways' class My 1100 multi-purpose locomotives have diesel-electric drive. With this system, electric motors on the axles are provided

with current from the generators which in turn are driven by diesel motors. This locomotive is very similar to the Belgian Type 204.

USA - "F 7"
diesel locomotive
of the Rio Grande
Railway Company



3062

Diesel locomotive · A model of the Rio Grande Railway Company version of the American B-B Type F 7 locomotive made by the Electro-Motive Division of General Motors · 2 driven axles · 4 non-skid tires · Remote control for forward and reverse drive · Lights as on original · Metal body in black, yellow, green and

aluminum color scheme · Coupling hook with advance uncoupler at driver's cab · Automatic coupling with advance uncoupler (RELEX) at rear end · Length 17.5 cm (6⁷/₈"')

⊙ = 7154 🚂 = 7185 🔦 = 60015

4062

Supplementary section, unpowered · Matching diesel locomotive 3062 · Lights as on original · Metal body · Coupling hook with advance uncoupler at driver's cab end · Length 17.5 cm (6⁷/₈"')

🚂 = 7185 🔦 = 60015

USA - "F 7"
diesel locomotive
of the Atchison Topeka
and Santa Fé Railway



3060

Diesel locomotive · A model of the Atchison Topeka and Santa Fé Railway version of the American B-B Type F 7 locomotive made by the Electro-Motive Division of General Motors · 2 driven axles · 4 non-skid tires · Remote control for forward and reverse drive · Lights as on original · Red and silver colored metal body · Cou-

pling hook with advance uncoupler at driver's cab · Automatic coupling with advance uncoupler (RELEX) at rear end · Length 17.5 cm (6⁷/₈"')

⊙ = 7154 🚂 = 7185 🔦 = 60015

4060

Supplementary section, unpowered · Matching diesel locomotive 3060 · Lights as on original · Red and silver-colored metal body · Coupling hook with advance uncoupler at driver's cab end · Length 17.5 cm (6⁷/₈"')

🚂 = 7185 🔦 = 60015

Electric railcar Railbus Rail Zeppelin



Electric railcar "515"
with control car "815"

3028

Electric railcar · A model of the German Federal Railways' B-2 battery-powered Type 515 railcar · 2 driven axles · 4 non-skid tires · Remote control for forward and reverse drive · At each end of the locomotive there are 3 headlights and 2 red tail lights which operate in accordance with the direction of motion · Turquoise and beige body ·

Interior fittings · Interior lighting · Windows inset in plastic frames · Coupling hook at each end · Length over buffers 24 cm (9½")

⊙ = 7154 ⊞ = 7164 ⊕ = 60001 r
⊕ = 60015 w

4028

Control car to go with railcar 3028 · A model of the German Federal Railways Type 815 control car · Turquoise and beige body · Interior fittings · Interior lighting · Windows inset in plastic frames · When coupled to railcar 3028, 3 headlights or 2 red tail lights operate at each end of the train, depending on the direction of motion · Coupling eye at

one end, coupling hook at the other end · Length over buffers 24 cm (9½")

⊞ = 7164 ⊕ = 60001 r
⊕ = 60015 w

8328

The same model as 3028, but arranged for 2 rail direct current (DC) operation

8428

The same model as 4028, but arranged for 2 rail direct current (DC) operation

Railbus with trailer



3016

Railbus · A model of the German Federal Railways Type 795 · 1 driven axle · 2 non-skid tires · Remote control for forward and reverse drive · 3 working headlights at each end · Interior lighting · Red body · Die cast zinc frame · Special symmetrical couplings at each end for coupling the cars tightly together · Length over buffers 14.7 cm (5¾")

⊙ = 7153 ⊞ = 7164 ⊕ = 60010

4018

Railbus trailer · A model of the German Federal Railways Type 995 · Red taillights operate at either end · Interior lighting · Red body · Special symmetrical

coupling, to fit railbus only · Length over buffers 12 cm (4¾")

⊞ = 7175 ⊕ = 60010

Rail Zeppelin

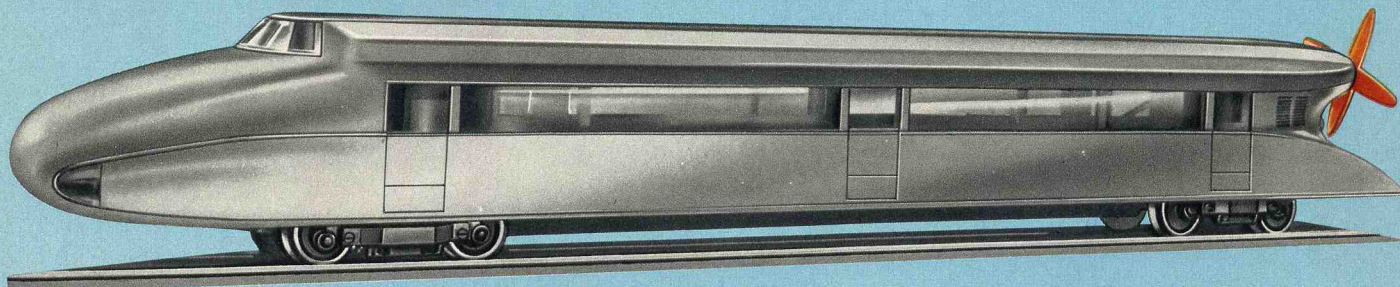

3077

Rail Zeppelin based on Kruckenberg's system · 4 axles · 2 driven axles · 4 non-skid tires · Remote control for forward and reverse drive · As the traction voltage is slowly increased from 4V, first the propeller spins up, driven by a special motor, and then the locomotive starts to roll ·

2 working headlights · Silver-gray body · Fitted windows with simulated struts · Die cast zinc frame · Length 28.8 cm (11¾")

⊙ = 7154 ⊞ = 7164 ⊕ = 60015

8377

The same model as 3077, but arranged for 2 rail direct current (DC) operation

The Rail Zeppelin, built for the Flugbahn-GmbH from Franz Kruckenberg's design, attained the world record speed of 230 km/h (143 mph) during reliability test runs in 1931. The drive was obtained from a 450 kW BMW aircraft engine at the rear of the vehicle, acting through the propeller.

"TEE" high speed railcar

3071

TEE high speed railcar, in three parts · A model of the Netherlands-Swiss TRANS-EUROP-EXPRESS train, consisting of a locomotive, a combined first class and dining car and a spacious first-class compartment car with driver's section · Length of model 70 cm (2 ft. 3^{3/16}")

Locomotive: 3 driven axles · 4 non-skid tires · Remote control for forward and reverse drive · Mat black die cast zinc frame · Body in the TEE colors, beige and red · Windows inset in plastic frames

Dining car and driver's car: Each with 2 accurately reproduced trucks · Body in the TEE colors, beige and red · Gray roof · Windows inset in plastic frames



Special couplings connect the 3 units very closely together · The walk-ways between the cars have specially tightly closing covers · At each end of the train there are 3 headlights and 2 red tail lights, which operate in accordance with the direction of motion · A current pick-up shoe at

each end of the train, the leading one always collecting the current

⊖ = 7154 ⊕ = 7164 ⚡ = 60015 w
⊖ = 7175 ⚡ = 60001 r



Northlander



3150

Diesel-electric high speed railcar, in 4 parts · A model of the Ontario Northland Railway "Northlander" · The train consists of a locomotive section, 2 center sections and a control section · Length of model 93.5 cm (3 ft. 3/4")

Locomotive section: 3 driven axles · 4 non-skid tires · Remote control for forward and reverse drive · Mat black die cast zinc frame · Body in the blue and yellow color scheme of the Ontario Northland Railway · Windows inset in plastic frames

Center sections and control section: 2 realistic trucks each · Body in blue and yellow · Windows inset in plastic frames

TEE high speed railcar

TRANS EUROP EXPRESS



4071



4071

TEE compartment coach · 1st class · 2 four-wheel trucks true to the original · Gray roof · Windows inset in plastic frames · Flexible covers for the walkways between cars at each end · Special coupling fitting the TEE train only · Length 23.3 cm (9 1/4")

The Netherlands-Swiss TRANS-EUROP-EXPRESS operated 5 trains on the Zürich-Amsterdam route as the TEE "Edelweiss". They usually consisted of 4 cars. Three powerful diesel motors developing a total of 1700 kW gave the train a speed of 140 km/h (87 mph). Windows could not be opened in this train, as every car was fully air conditioned. As in all TEE trains,

there were only 1st class coaches, containing 114 seats. The dining car section could seat 32.

The TEE train illustrated consists of the three-part unit 3071 together with the supplementary car 4071, giving the usual four-car composition. Length over the 4 unit train is 93.5 cm (3 ft. 1/4").

The train TEE RAm 501 was taken out of service after an accident. The remaining 4 trains were withdrawn in May 1974 and were subsequently purchased by Canada.

The Ontario Northland Transportation Commission (ONTC) purchased the four surviving TEE high speed railcar trains on 9th October 1976. The trains were thoroughly overhauled and equipped to Canadian standards, the front and rear cars being fitted with number boxes, signal lights, sirens, antennas and bells. The windows were triple-glazed. The colors of Ontario were chosen for the exterior finish.

The first Northlander was shipped right on schedule from Rotterdam on 29th March 1977. These high speed railcar trains are now operating on the Toronto-North Bay-Timmins-Kapuskasing route.



Märklin have limited production of the Northlander to 5000 sets only.

Northlander



The front and rear cars have the usual North American features: Number boxes, signal lights, sirens, an antenna and a warning bell

Special couplings connect the 4 units very closely together · The walkways between the cars have special tightly closing covers · **All cars have interior lighting installed** · At each end of the train there are three headlights and two taillights which operate in accordance with the

direction of motion · A current pick-up shoe at each end of the train, the leading one always collecting the current.

⊙ = 7154 ⊞ = 7164 ⊕ = 60001 r
 ⊞ = 7175 ⊕ = 60015 w

Local service coaches

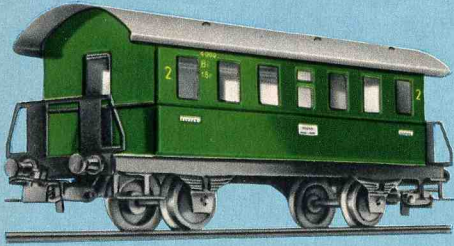

4000

Local service coach · Platform and entrance at each end · Unglazed windows · Length 11.5 cm (4 1/2")

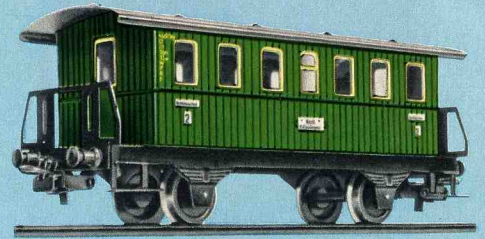

4040

Local service coach · Platform and entrance at each end · Unglazed windows · Length 11.5 cm (4 1/2")

Local service coaches with automatic coupling and advance uncouplers RELEX (see page 49)

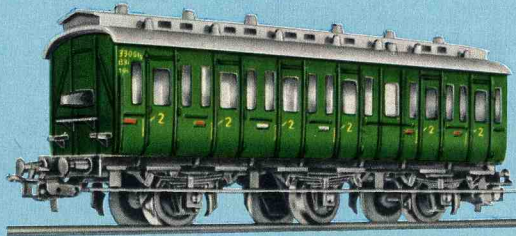

4004

Compartment car without brakeman's cab · Car sides divided into 6 compartments · Windows glazed with "cellon" panes · Length 13 cm (5 1/8") · This car can be fitted with interior lighting set 7074 (see page 54)

4005

Compartment car with brakeman's cab · Car sides divided into 6 compartments · Windows glazed with "cellon" panes · Length 13 cm (5 1/8") · This car can be fitted with interior lighting set 7074 (see page 54)

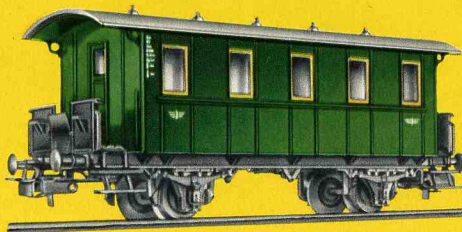
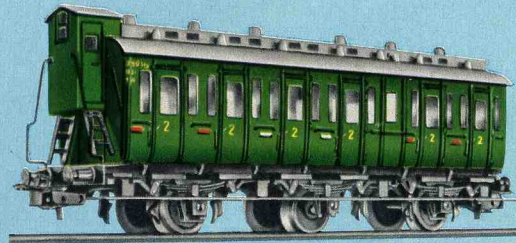

4007

Local service coach · Modeled on a private railroad coach · Platform and entrance at each end · Plastic car body · Imitation ventilators on roof · Windows inset in plastic frames · Interior fittings · Length 11 cm (4 1/4") · This car can be fitted with interior lighting set 7323 (see page 54)

4008

Baggage car · Modeled on the Type Pwi No. 0116911 Stgt. · Platform and entrance at each end · Plastic car body · Imitation ventilators, superstructure for conductor's cab · Windows inset in plastic frames · Length 11 cm (4 1/4") · This car can be fitted with interior lighting set 7323 (see page 54)



Passenger cars

Local service coaches

German Federal Railways local service coaches

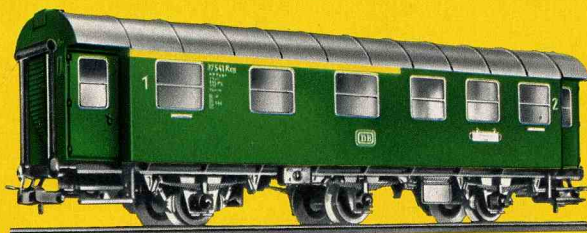

4067 **new**

Local service coach · A model of the German Federal Railways' Type AB3yge · Plastic car body · Windows inset in plastic frames · Simulated rubber beading · Length 15.2 cm (6'') · This car can be fitted with interior lighting set 7074 (see page 54)

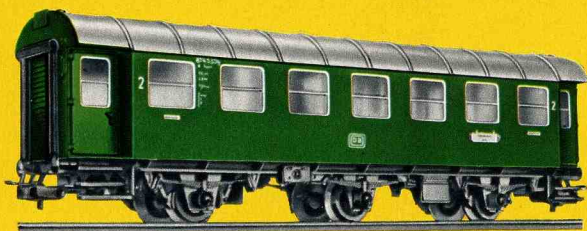

4079

Local service coach · A model of the German Federal Railways' Type B3yge · Plastic car body · Windows inset in plastic frames · Simulated rubber beading · Length 15.2 cm (6'') · This car can be fitted with interior lighting set 7074 (see page 54)



4080



Local service coach with baggage compartment · A model of the German Federal Railways' Type BD3yge · Plastic car body · Windows inset in plastic frames · Simulated rubber beading · Length 15.2 cm (6'') · This car can be fitted with interior lighting set 7074 (see page 54)

German Federal Railways' local passenger service cars with interior fittings

4077

Local passenger service car with baggage compartment and driver's

cab · 2nd class · A model of the German Federal Railways' Type BDnf · Car body stainless steel-colored with peacock's eye pattern · Interior fittings · Windows with plastic frames · Dummy hooter on roof · Headlights at the cab end · Length 24 cm (9 1/2'') · This car can be fitted with the interior lighting set 7077 (see page 54)

 = 7175  = 60000



4082

Local passenger service car · 2nd class · A model of the German Federal Railways' Type Bnb · Car body stainless steel-colored with peacock's eye pattern · Interior fittings · Windows with plastic frames · Length 24 cm (9 1/2'') · This car can be fitted with the interior lighting set 7077 and the current pick-up shoe 7198 (see page 54)



4083

Local passenger service car · 1st and 2nd class · A model of the German Federal Railways' Type ABnb · Car body stainless steel-colored with peacock's eye pat-

tern · Interior fittings · Length 24 cm (9 1/2'') · This car can be fitted with the interior lighting set 7077 and the current pick-up shoe 7198 (see page 54)





4135 **new**

Express coach · 3rd class · A model of the former Royal Bavarian Railways' Type CCü · Plastic car body · Windows inset in plastic frames · Interior fittings · Imitation ventilators on roof · Length 22 cm (8⁵/₈"') · This car can be fitted with interior lighting set 7326 (see page 54)

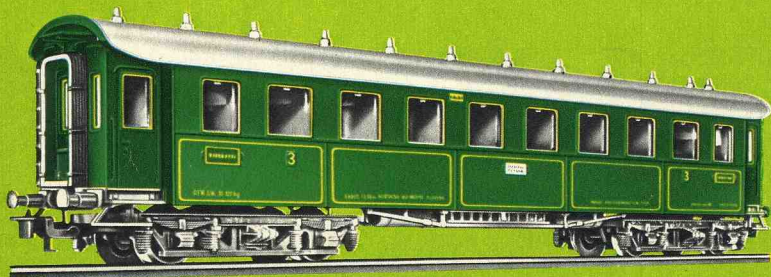

4136

Express coach · 3rd class, old-fashioned design · A model of the former German State Railways' Type (C4ü bay 11) · Windows inset in plastic frames · Interior fittings · Imitation ventilators on roof · Length 22 cm (8⁵/₈"') · This car can be fitted with interior lighting set 7326 (see page 54)

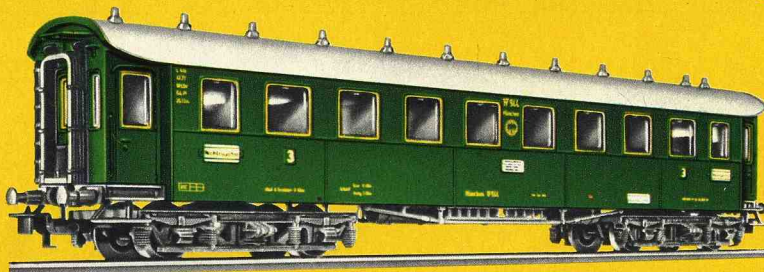

4137

Express baggage car · An old-fashioned design · A model of the former German State Railways' Type (Pw4ü bay 09) · Windows inset in plastic frames · Roof superstructure · Length 20 cm (7⁷/₈"') · This car can be fitted with interior lighting set 7326 (see page 54)

Accurate scale models

4139 **new**

Express coach · 2nd class · A model of the German Federal Railways' Type Büe³⁵⁴ · Plastic car body · Windows inset in plastic frames · Interior fittings · Görnitz-type trucks · Length 25 cm (10") · This car can be fitted with interior lighting set 7327 (see page 54)

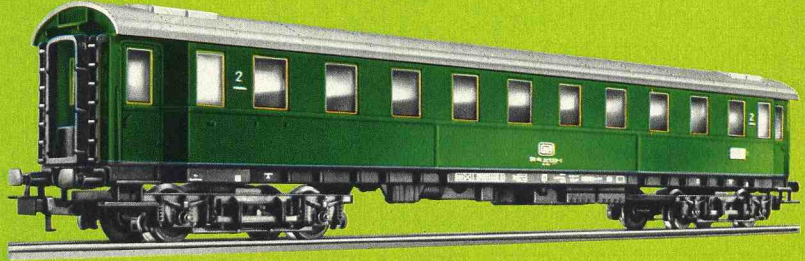

4140 **new**

Express baggage car · A model of the German Federal Railways' Type Düe⁹³² · Plastic car body · Windows inset in plastic frames · Roof superstructure · Görnitz-type trucks · Length 22.6 cm (9") · This car can be fitted with interior lighting set 7327 (see page 54)



4141 **new**

Express coach · 3rd class · A model of the former German State Railways' Type C4ü 31 · Plastic car body · Windows inset in plastic frames · Interior fittings · Görnitz-type trucks · Length 25 cm (10") · This car can be fitted with interior lighting set 7327 (see page 54)

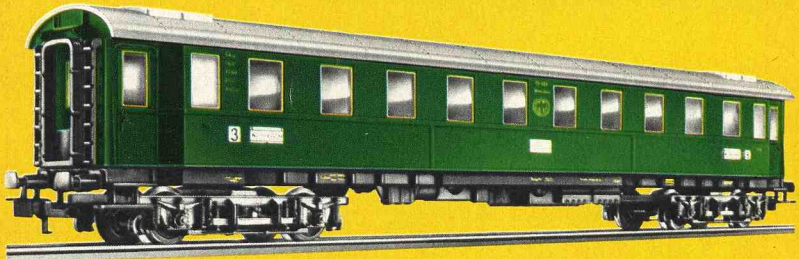

4142 **new**

Express baggage car · A model of the former German State Railways' Type Pw4ü 30 · Plastic car body · Windows inset in plastic frames · Roof superstructure · Görnitz-type trucks · Length 22.6 cm (9") · This car can be fitted with interior lighting set 7327 (see page 54)

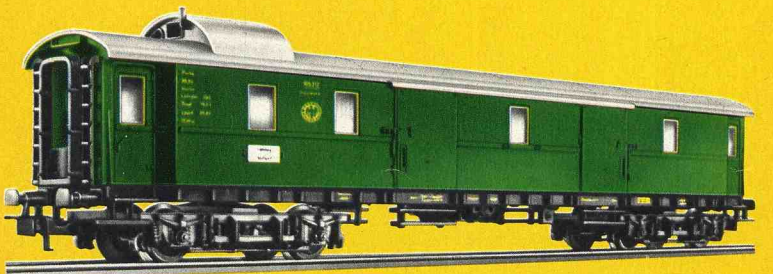

TEE coaches with interior fittings 24 cm (9½'')

TEE coaches with
interior fittings

4085

TEE compartment car · 1st class · A model of the German Federal Railways' Type Avm · Windows inset in plastic frames · Interior fittings with

side corridor · Length 24 cm (9½'') · This car can be fitted with the interior lighting set 7320 (see page 54)





4087

TEE dining car · A model of the German Federal Railways' Type WRm · Windows inset in plastic frames · Interior fittings, divided into kitchen and dining sections · Length 24 cm (9½'') · This car can be fitted with the interior lighting set 7320 (see page 54)



4089

TEE compartment car · Similar to car 4085, but with current pick-up shoe and wiring for interior lighting and tail-lights

 = 7175  = 60015



7589

Pack of wheel sets, consisting of 4 sets of wheels · For conversion of cars 4026, 4029, 4037, 4045, 4049, 4051, 4052, 4064, 4066, 4068, 4072, 4073, 4076, 4085, 4087, 4090, 4111 and 4112 for two-conductor direct current operation

4090

TEE dome car · 1st class · A model of the German Federal Railways Type ADm · Windows inset in plastic frames · Interior fittings · Transparent plastic dome · Length 24 cm (9½'') · This car can be fitted with the interior lighting set 7322 (see page 54)



Express coaches with interior fittings 24 cm (9½'')

German Federal Railways' express coaches

4026

Express baggage car · A model of the German Federal Railways Type D ym · Windows inset in plastic frames · Length 24 cm (9½'') · This car can be fitted with interior lighting set 7077 and current pick-up shoe 7198 (see page 54)

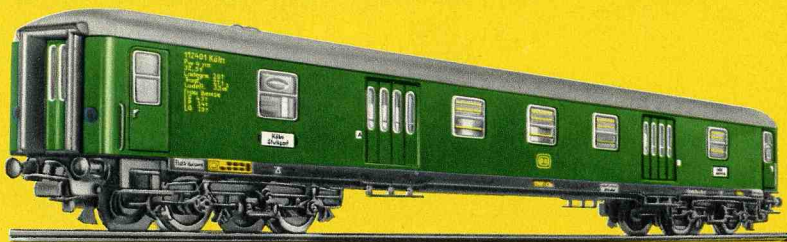

4051

Express coach · 1st class · A model of the German Federal Railways Type A üm · Interior fittings · Windows inset in plastic frames · Length 24 cm (9½'') · This car can be fitted with interior lighting set 7077 and current pick-up shoe 7198 (see page 54)



Express coach · Similar to 4051, but with tail-lights and current pick-up shoe

☞ = 7175 ☉ = 60015

4053



4052

Express coach · 2nd class · A model of the German Federal Railways' Type B üm · Interior fittings · Windows inset in plastic frames · Length 24 cm (9½'') · This car can be fitted with interior lighting set 7077 and current pick-up shoe 7198 (see page 54)

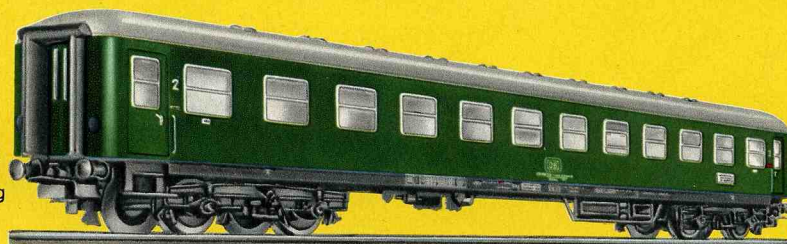

4054

Express dining car · A model of the German Federal Railways' Type WR üm¹³² · Interior fittings, divided into kitchen and dining sections · Windows inset in plastic frames · Length 24 cm (9½'') · This car can be fitted with interior lighting set 7320 (see page 54)

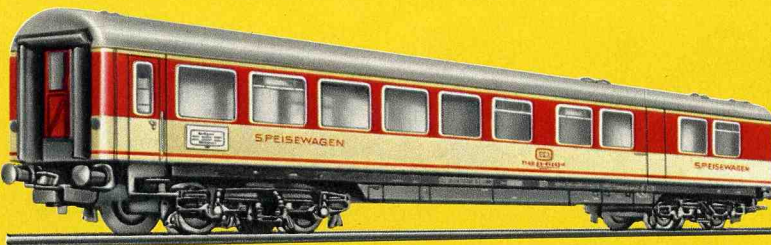

4111

Express coach · 1st class · A model of the German Federal Railways' Type A üm · Interior fittings · Windows inset in plastic frames · Length 24 cm (9½'') · This car can be fitted with interior lighting set 7077 and current pick-up shoe 7198 (see page 54)



4112

Express coach · 2nd class · A model of the German Federal Railways Type B üm · Interior fittings · Windows inset in plastic frames · Length 24 cm (9½'') · This car can be fitted with interior lighting set 7077 and current pick-up shoe 7198 (see page 54)



The bodies of our express cars are made of metal or plastic, with inset plastic window frames and panes. Door bays and other important details and the tiny indelible lettering are modeled exactly on the original. The mat finish makes the cars look completely realistic. The cars can easily be fitted with interior lighting. The simulated Minden-Deutz type trucks have movable side plates which compensate for irregularities in the track and permit a safe and quiet ride. The inter-connections between cars are fitted with simulated rubber beading or bellows. Automatic coupling with advance uncoupler (RELEX).

Express coaches 24 cm (9½'')

The express and local passenger service cars on pages 40/41 are equipped with automatic coupling and advance uncouplers (RELEX).

4029

Express sleeping car · A model of the International Sleeping Car Co.'s Type ISG No. 4581 · Windows inset in plastic frames · Length 24 cm (9½'') · This car can be fitted with interior lighting set 7077 and current pick-up shoe 7198 (see page 54)



German Federal Railways' express coaches

4037

Express coach · 2nd class, one of the older designs · A model of a type used by German Federal Railways · Windows with "cellon" panes · Length 22 cm (8⅝'') · This car can be fitted with interior lighting set 7077 and current pick-up shoe 7198 (see page 54)



4064

Express sleeping car · 1st and 2nd class · A model of the German Sleeping and Diner Car Co.'s (DSG) WL AB um Series 33 200 · Windows inset in plastic frames · Length 24 cm (9½'') · This car can be fitted with interior lighting set 7320 (see page 54)



Lightweight express coaches of the Swiss Federal Railways

4066

Passenger car · A model of the Swiss Federal Railways' Series A 2500 1st class coach · Windows inset in plastic frames · Roof with longitudinal ribs and imitation ventilators · Length 24 cm (9½'') · This car can be fitted with interior lighting set 7320 (see page 54)



4068

Express dining car · A model of the Swiss Federal Railways' Type RIC dining car · Windows inset in plastic frames · Screwed-on roof with longitudinal ribs · Single bar current collector on roof · Length 24 cm (9½'') · This car can be fitted with interior lighting set 7077 (see page 54)



Interior fittings for coaches 4037, 4045, 4049, 4066, 4067, 4072, 4073, 4079 and 4080

Interior fittings and figures are made in finely detailed plastic, the figures being hand painted. Illustrated installation instructions are included with every set.

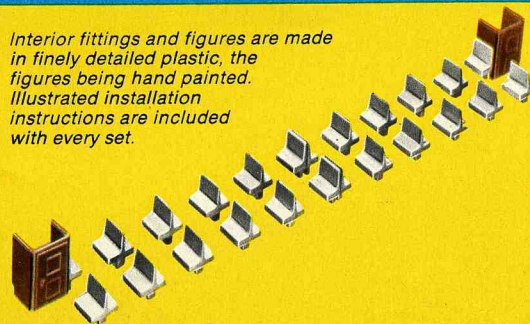

0225

Set of interior fittings for express coaches, with 18 single-colored double seats, 6 single seats and 2 rest rooms



0226

Pack with 10 realistically-colored figures to supplement the interior fittings

International express coaches

Danish State Railways' express coach

4045

Express coach · 2nd class · A model of the Danish State Railways' (DSB) Type B 2300 · Windows inset in plastic frames · Length 24 cm (9½") · This car can be fitted with interior lighting set 7077 and current pick-up shoe 7198 (see page 54)

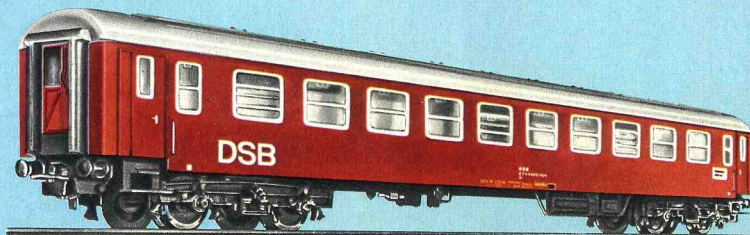

Netherlands Railways' express coach

4049

Express passenger coach · 2nd class · A model of the Netherlands Railways' Type B 6600 · Windows inset in plastic frames · Length 24 cm (9½") · This car can be fitted with interior lighting set 7320 (see page 54)



Swedish State Railways' express coaches

4072

Express coach · 2nd class · A model of the Swedish State Railways' Type Bo 1 · Plastic car body · Windows inset in plastic frames · Length 23.7 cm (9⅜") · This car can be fitted with interior lighting set 7197 (see page 54)

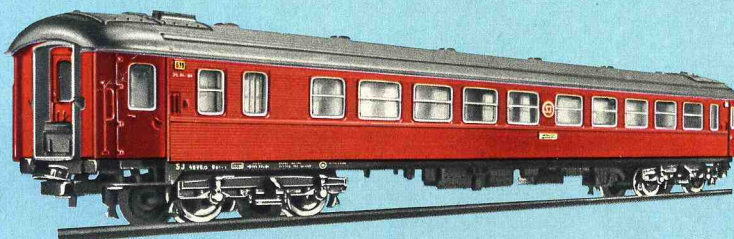

4073

Express dining car · A model of the Swedish State Railways' Type RBo 2 · Plastic car body · Windows inset in plastic frames · Length 23.7 cm (9⅜") · This car can be fitted with interior lighting set 7197 (see page 54)

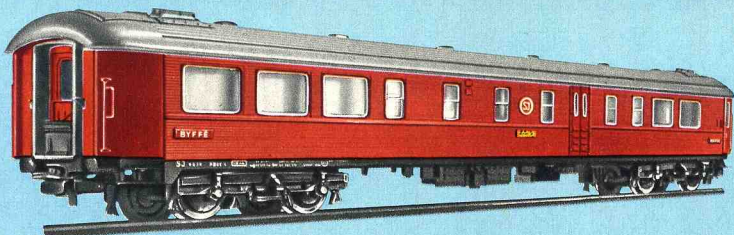

French State Railways' express coach

4076

Express coach · 1st class · A model of the SNCF's stainless steel Type A8myfi · Plastic body · Interior fittings · Windows inset in plastic frames · Length 24 cm (9½") · This car can be fitted with interior lighting set 7197 (see page 54)

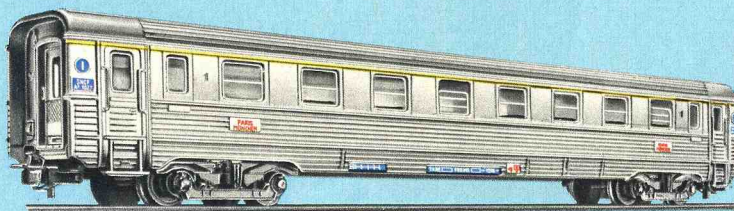

TEE coaches and sleeping cars with interior fittings 27 cm (10⁵/₈'')

4150

Express sleeping car · 1st and 2nd class · A model of the German Federal Railways' Type WLAbSm in the TEN version · Plastic car body · Interior fittings · Windows inset in plastic frames · Length 27 cm (10⁵/₈'') · This car can be fitted with interior lighting set 7325 (see page 54)



4151 **new**

Express sleeping car · 1st and 2nd class · A model of the Netherlands Railways (NS) TEN car · Blue painted plastic car body · Interior fittings · Windows inset in plastic frames · Length 27 cm (10⁵/₈'') · This car can be fitted with interior lighting set 7325 (see page 54)



4095

TEE compartment car · 1st class · A model of the German Federal Railways' Type Avm · Plastic car body · Interior fittings with side corridor · Windows inset in plastic frames · Length 27 cm (10⁵/₈'') · This car can be fitted with interior lighting set 7325 (see page 54)



4096

TEE open-interior coach · 1st class · A model of the German Federal Railways' Type Apm · Plastic car body · Interior fittings, seats arranged in one single and one double row separated by gangway · Windows inset in plastic frames · Length 27 cm (10⁵/₈'') · This car can be fitted with interior lighting set 7325 (see page 54)

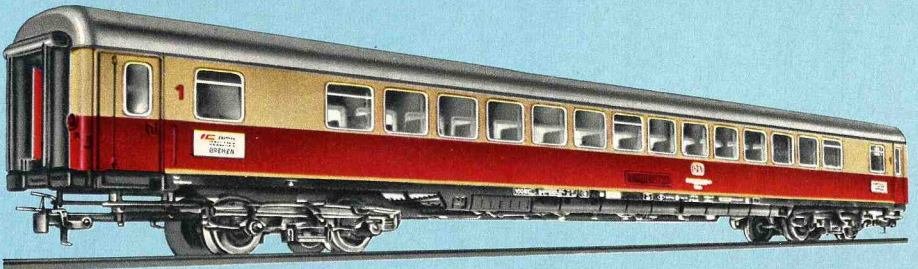

4097

TEE dining car · A model of the German Federal Railways' Type WRm · Plastic car body · Interior fittings, divided into kitchen and dining sections · Windows inset in plastic frames · Length 27 cm (10⁵/₈'') · This car can be fitted with interior lighting set 7325 (see page 54)



4099

TEE dome car · 1st class · A model of the German Federal Railways' Type ADm · Plastic car body · Interior fittings, divided into bar, seating compartment and raised row of seats · Transparent plastic observation dome · Windows inset in plastic frames · Length 27 cm (10⁵/₈'') · This car can be fitted with interior lighting set 7325 (see page 54)



Express coaches, 27 cm (10⁵/₈'')

with interior fittings

Automobile rack cars

4091

Express coach · 1st class · A model of the German Federal Railways' Type A üm²⁰¹ · Plastic car body · Interior fittings · Windows inset in plastic frames · Length 27 cm (10⁵/₈'') · This car can be fitted with interior lighting set 7325 (see page 54)

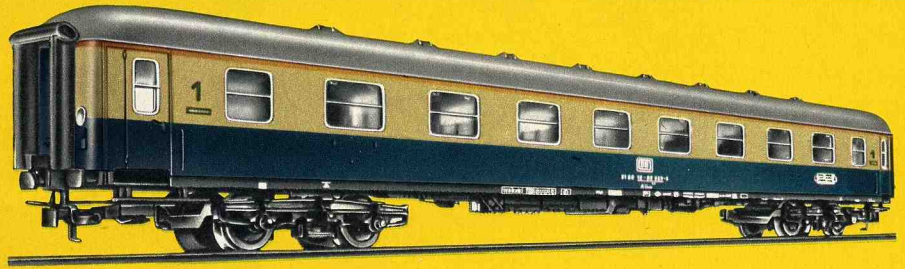

4092

Express coach · 2nd class · A model of the German Federal Railways' Type B üm²⁰⁴ · Plastic car body · Interior fittings · Windows inset in plastic frames · Length 27 cm (10⁵/₈'') · This car can be fitted with interior lighting set 7325 (see page 54)



4093

Express baggage car · A model of the German Federal Railways' Type D üm²⁰² · Plastic car body · **Moveable roller shutters** on each side · Windows inset in plastic frames · Length 27 cm (10⁵/₈'') · This car can be fitted with interior lighting set 7325 (see page 54)



4094

Express dining car · A model of the German Federal Railways' Type WR ümh¹³² · Plastic car body · Interior fittings, divided into kitchen and dining sections · Windows inset in plastic frames · Length 27 cm (10⁵/₈'') · This car can be fitted with interior lighting set 7325 (see page 54)



4074

Automobile rack car · A model of the German Federal Railways' Type DDm 915 · With 8 WIKING miniature automobiles aboard · Length 26.4 cm (10³/₈'')

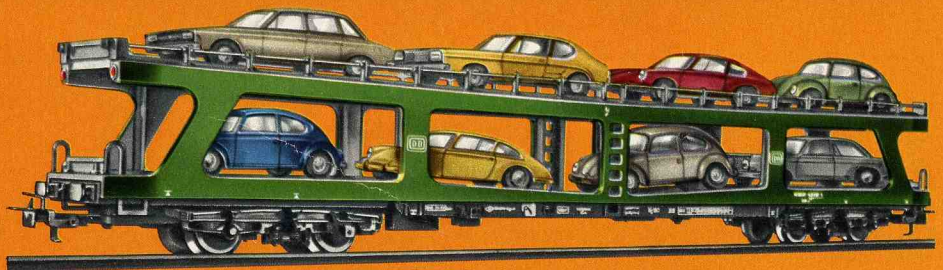

4084

Automobile rack car · A model of the German Federal Railways' Type DDm 915 · Without automobiles · Length 26.4 cm (10³/₈'')

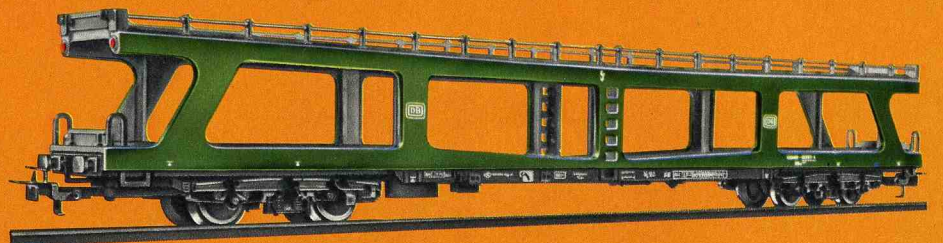

Scale model freight cars with automatic coupling and advance uncouplers RELEX (see page 49)

Underframes and bodies are made of plastic, wheels of die cast zinc.



4410

Box car · A model of the German Federal Railways' Type Gs · Length 11.5 cm (4 1/2")

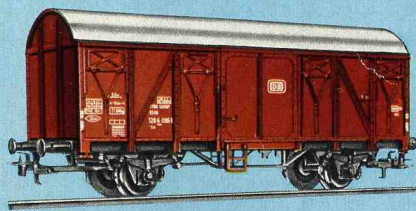

4411

Box car with working tail-light · A model of the German Federal Railways' Type Grs-v · Current pick-up shoe · Length 11.5 cm (4 1/2")

☞ = 41494 Ⓞ = 60015



4413

Tipping bucket car · Bucket can tip to either side or be latched in the upright position · Length 11.5 cm (4 1/2")

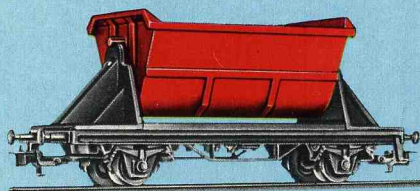

4414

Box car for transporting bananas · A model of the German Federal Railways' Type lbbls · Length 11.5 cm (4 1/2")



4415

Refrigerator car · A model of the German Federal Railways' Type lchqrs 377 · Length 11.5 cm (4 1/2")

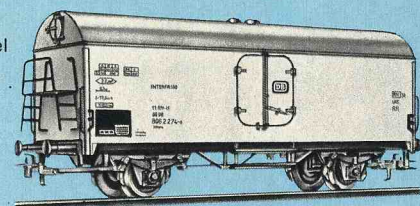

4416

Beer car · A model of a car owned by the Dortmund Kronen brewery · Length 11.5 cm (4 1/2")

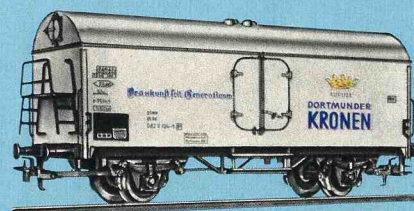

4417

Beer car · A model of a car owned by the Alpirsbacher Klosterbräu brewery · Length 11.5 cm (4 1/2")



4418 **new**

Beer car · A model of a car owned by the Duisburg König Brewery · Length 11.5 cm (4 1/2")



4423

Low-sided car · A model of the German Federal Railways' Type Kklm 505 · Length 11.5 cm (4 1/2")



4424

Low-sided car · Loaded with WIKING commercial vehicle · Length 11.5 cm (4 1/2")

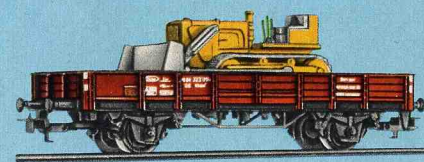

Scale model freight cars 4400

Freight cars 4500



4430

Open freight car · A model of the German Federal Railways' Type EI-u · Length 11.5 cm (4 1/2'')

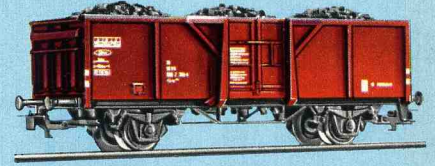

4431

Open freight car (DB-EI-u) · With removable load, representing coal · Length 11.5 cm (4 1/2'')

4440

Tank car · ARAL · Length 11.5 cm (4 1/2'')



4441

Tank car · ESSO · Length 11.5 cm (4 1/2'')

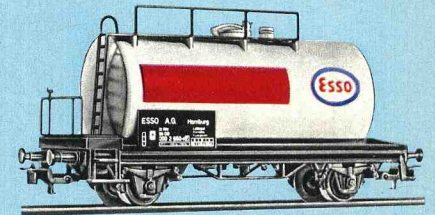

4442

Tank car · SHELL · Length 11.5 cm (4 1/2'')



4474 *new*

Low-sided car · Loaded with grade builder and shovel loader · Length 16 cm (6 5/16'')



4473 *new*

Low-sided car · A model of the German Federal Railways' Type Rlms · Length 16 cm (6 5/16'')



4475 *new*

Low-sided car with wagon sheet · Length 16 cm (6 5/16'')



7586

Pack of wheel sets, consisting of 4 sets of wheels · For conversion of cars 4074, 4084, 4091, 4092, 4093, 4094, 4095, 4096, 4097, 4099, 4135, 4136, 4137, 4139, 4140, 4141, 4142, 4150, 4151, 4410, 4413, 4414, 4415, 4416, 4417, 4418, 4423, 4424, 4430, 4431, 4440, 4441, 4442, 4473, 4474 and 4475 for two-conductor direct current operation



4510

Wine car · Length 10 cm (4'')

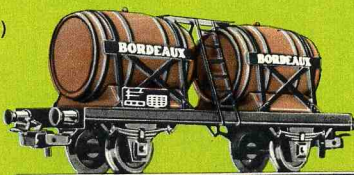

4511

Pulverized coal car · Length 10 cm (4'')



4600

Freight train baggage car
(German Federal Railways'
Type Dg) · Doors on both
sides which will open ·
Length 9 cm (3½")



4601

Open freight car
with brakeman's cab
(German Federal Railways'
Type Omm 33) · Length
11.5 cm (4½")



4605

Box car with brakeman's
cab (Swiss Federal Rail-
ways' Type K³) · Doors on
both sides which will
open · Length 11 cm (4¼")



4607

Low sided car (German
Federal Railways' Type
Rmms 33) with removable
stanchions which can be
stored in the sliding box
under the car floor ·
Length 13 cm (5⅛")

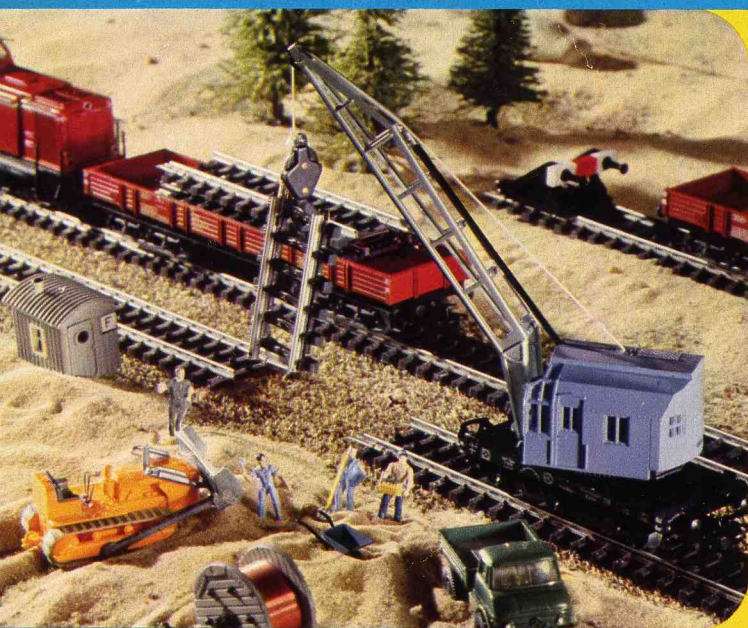
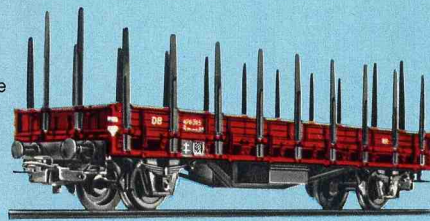

4611

Crane car with rotating crane, with movable boom and boom support ·
Crane hook can be raised and lowered by hand-cranking · Length of
underframe 9 cm (3½") · (Low-sided car 4423 is not included in the price,
but this item is recommended for use when moving the crane car)

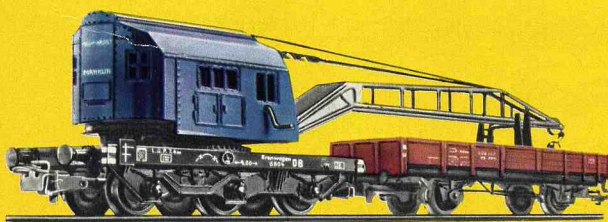

4617

Well car · Loaded with transformer ·
Length 25 cm (9⅞")

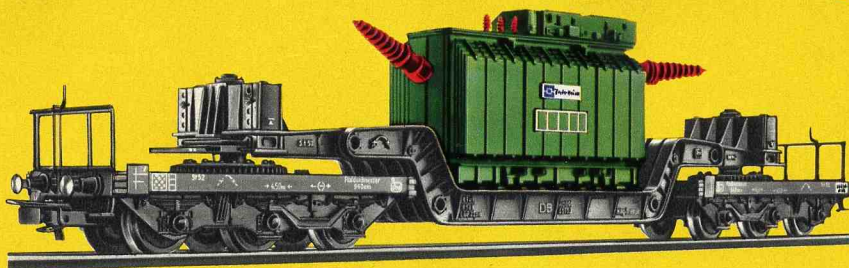

4618

Well car · Loaded with crate · Length 25 cm (9⅞")

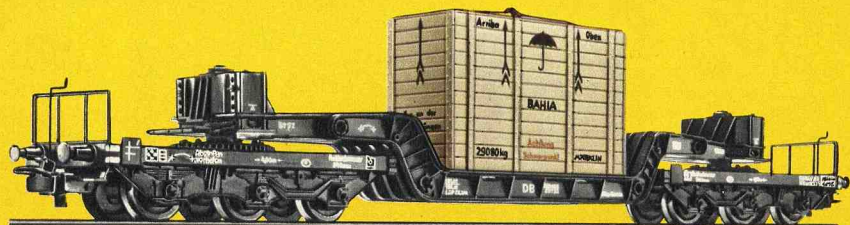

7587

Pack of wheel sets, consisting of 3 sets
of wheels · For conversion of cars 4611,
4617 and 4618 for two-conductor direct
current operation



Scale model freight cars 4600

4610

Ballast car with unloading doors operated by a hand lever · Length 9.5 cm (3³/₄"')

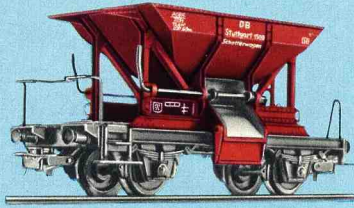

4612

Automobile transporter with loading ramp · Not loaded · Length 11.5 cm (4¹/₂"')

(On the German Federal Railways two transporters are always coupled together to form a unit known as Off 52)



4613

Automobile transporter with loading ramp · Loaded with miniature automobiles · Length 11.5 cm (4¹/₂"')

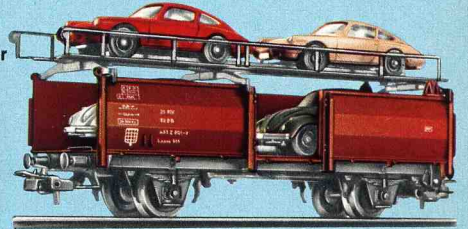

4619

Sliding-roof car (German Federal Railways' Type Kmmks 51) · The two halves of the roof will slide open · Length 11.5 cm (4¹/₂"')



4627

Box car · A model of the German Federal Railways' Type Glimmehs 57 · Length 13.3 cm (5¹/₄"')

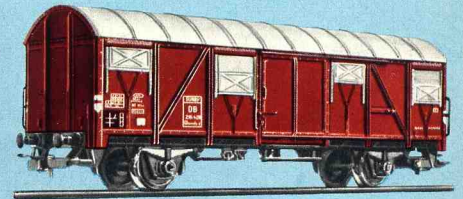

4624

High-capacity freight car · A model of the German Federal Railways' Type Ootz 50 · Length 13.3 cm (5¹/₄"')



This type of car is used in international traffic for transporting coal, coke, ore etc. generally in permanently made-up high capacity trains.

4626

High-capacity freight car with hinged hatches on roof · A model of the German Federal Railways' Type KKt 57 · All hatches will open · Length 13.3 cm (5¹/₄"')



On a number of high-capacity freight cars, fixed covers are fitted so that bulk materials such as grain, which need protection from the elements, can be carried.

4631

Side dumping car · A model of the German Federal Railways' Type Otmm 70 · Length 11.2 cm (4³/₈"')



The discharge doors can be operated by handlevers, or by remote control using the uncoupling track sections 5112 (see page 58) and 2197 (page 60).

4632

Beer car · Length 19.5 cm (7³/₄"')



4633

Freight car with sliding sides and roof (German Federal Railways' Type Klimmgs 66) · The roof halves and the sides will slide open · Length 15.7 cm (6 1/4")

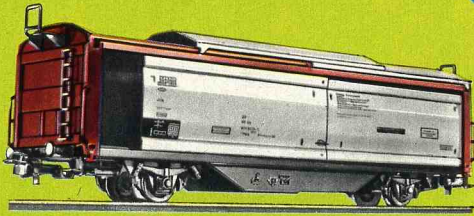

4639

Open freight car · A model of the Netherlands State Railways' (NS) car · Length 11.5 cm (4 1/2")

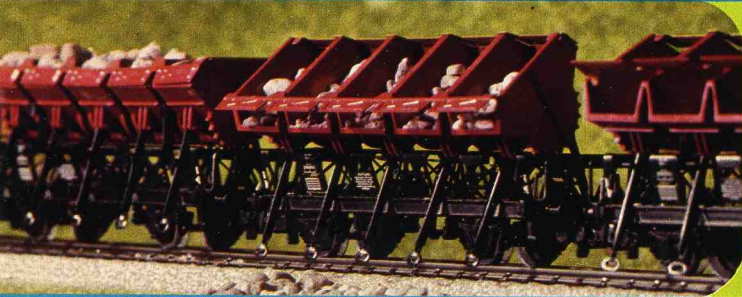

4635

Tipping bucket car · A model of the German Federal Railways' Type Omni 51 · The buckets can be tipped when the center holding bar is unlatched · Length 10.5 cm (4 1/8")



4644

Tank car · A model of the standard tank car, with BP markings · Length 10 cm (4")



4646

Tank car · A model of the standard tank car, with ARAL markings · Length 10 cm (4")

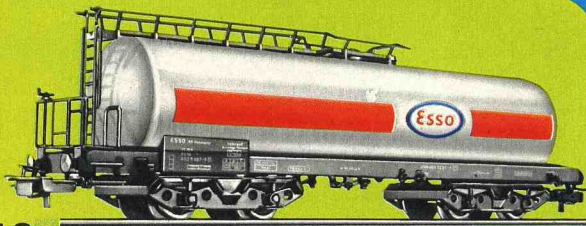

4650 Tank car · ESSO · Length 16.4 cm (6 1/2")



4651 Tank car · SHELL · Length 16.4 cm (6 1/2")

new



4652 Tank car · TEXACO · Length 16.4 cm (6 1/2")



4661

Tank car for fine bulk material · A model of the German Federal Railways' Type Ucs (Kds 54) with the marking "Quarz-Werke" · Length 10 cm (4")

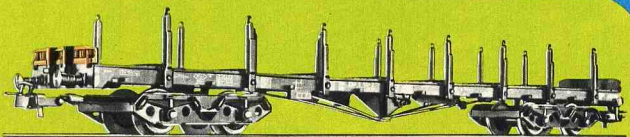

4663

Flatcar · A model of the German Federal Railways' Type SSImas 53 · Car floor made of die cast zinc · Uprights can fold down · Length 22.7 cm (9")

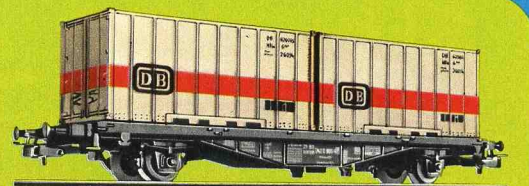

4664

Container car · A model of the German Federal Railways' "Berlin" type container car · Loaded with 2 removable containers · Length 15.6 cm (6 1/8")

Scale model freight cars 4600 American freight cars

7588

Pack of wheel sets, consisting of 4 sets of wheels · For conversion of cars 4600, 4601, 4605, 4607, 4610, 4612, 4613, 4619, 4627, 4639, 4661, 4665 and 4669 for two-conductor direct current operation

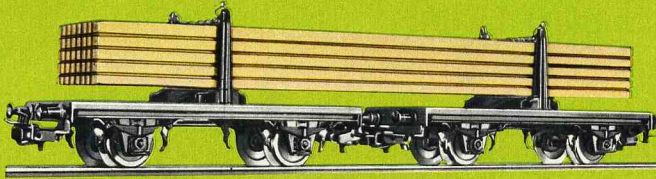

4665 Lumber car in two parts · Loaded with sawn lumber · Length 19.5 cm (7³/₄"')



4668

Container car · A model of the German Federal Railways' "Berlin" type container car · Loaded with 2 removable containers · Length 15.6 cm (6¹/₈"')

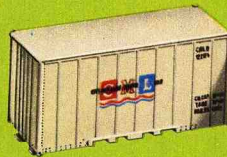

7291

Pack of 4 containers with different markings · Will fit on underframes of cars 4664 and 4668



4669

Beer car · A model of a car owned by the Kulmbacher Reichelbräu brewery · Imitation ventilators on roof · Length 13.3 cm (5¹/₄"')

Scale model freight cars with automatic coupling and advance uncouplers RELEX

We have paid particular attention to the details of these models. The RELEX coupling is essential for realistic switching. When the coupling has been opened by means of an uncoupling track section, the catch of the coupling stays open so that the car can be pushed away or allowed to roll down a ramp.



American freight cars

4571

Box car · A model of a 50 ton car of Western Pacific Railroad · Walkway mounted on roof · Doors on both sides which will open · Length 20.5 cm (8¹/₁₆"')

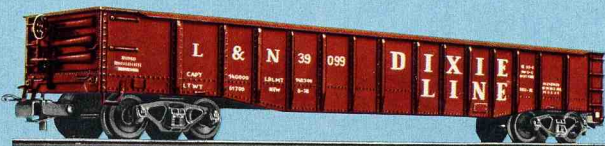
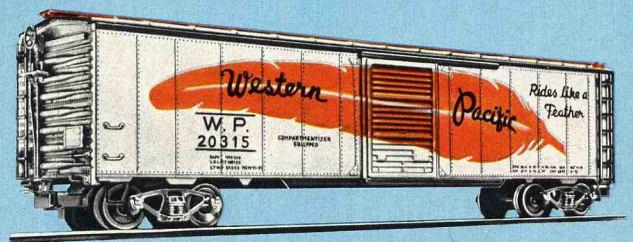

4575

Gondola · A Dixie Line model · Length 20 cm (7⁷/₈"')



4578

Caboose · Roof structure with walkway and ladders · Length 8 cm (3¹/₈"')

A turntable and roundhouse make a steam locomotive layout even more realistic. The turntable is used to turn locomotives round on the spot and get the smoke stack in front. Most steam locomotives are permitted to travel forwards faster than in reverse. The turntable is also used to feed locomotives into the 3 or 6 track roundhouse or to put them back on the right departure track. Current is disconnected from all sidings not in contact with the turntable track.

Locomotive roundhouse building kit

7288

Locomotive roundhouse building kit, made of plastic · With 3 automatically closing doors for 3 tracks · (Track section not included) · Base 442 × 350 mm (1 ft. 5³/₈" × 1 ft. 1³/₄") · Height 128 mm (5")

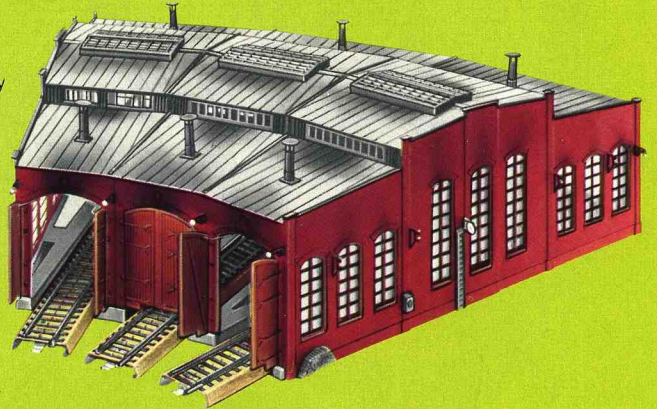

Remote controlled turntable

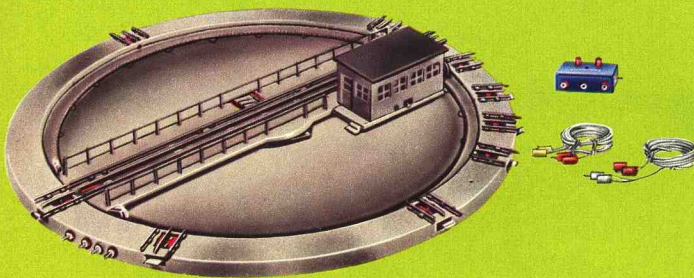

7186

Turntable set · Consisting of turntable with 360 mm (1 ft. 2¹/₈") outside diameter turning in either direction by remote control, with reversing switch and lead · Current is automatically cut off from all sidings not in contact with the turntable track

Adapter track section 2191 (see page 60) enables K-tracks of the 2100 series to be connected to the turntable 7186.

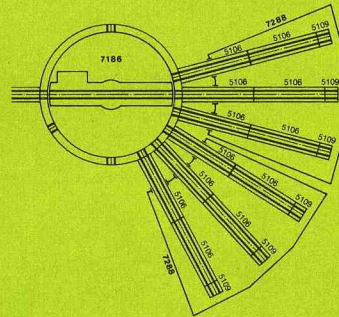

This illustration shows the realistic effect obtained by combining 2 roundhouse sections and a turntable.

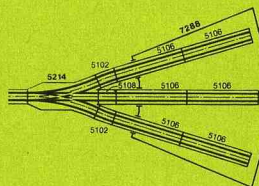

Suggested combination of roundhouse 7288 with three-way turnout 5214.

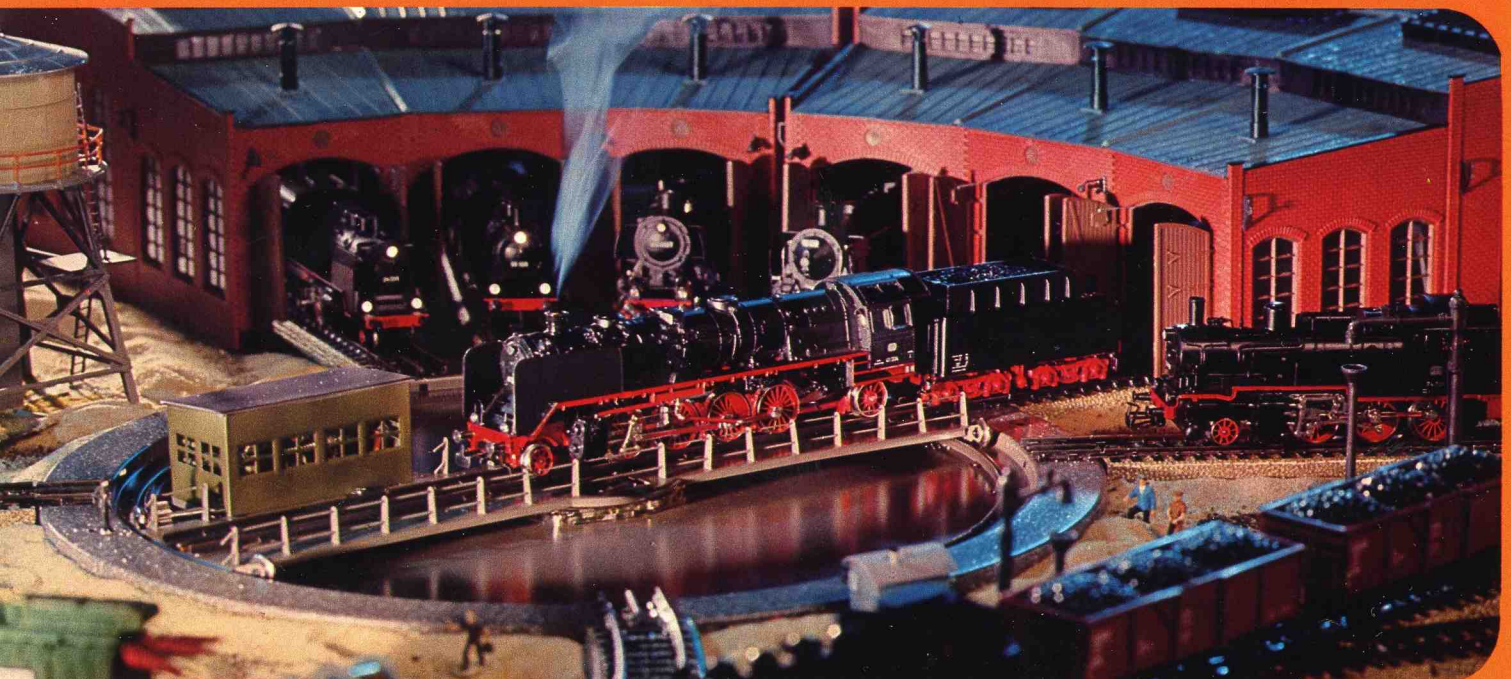

Remote controlled rotating crane

7051

Remote controlled rotating crane with lifting magnet · One motor rotates the boom, another raises and lowers the load · Load hook and lifting magnet enable iron or iron-containing objects to be transferred by remote control · Boom elevation adjustable by hand · Working light in control cab · Height 260 mm (10¹/₄"') · Base 90 × 90 mm (3¹/₂"' × 3¹/₂"') · 1 combined control and switch panel · Price does not include locomotive, cars or track
 Ⓞ = 60000

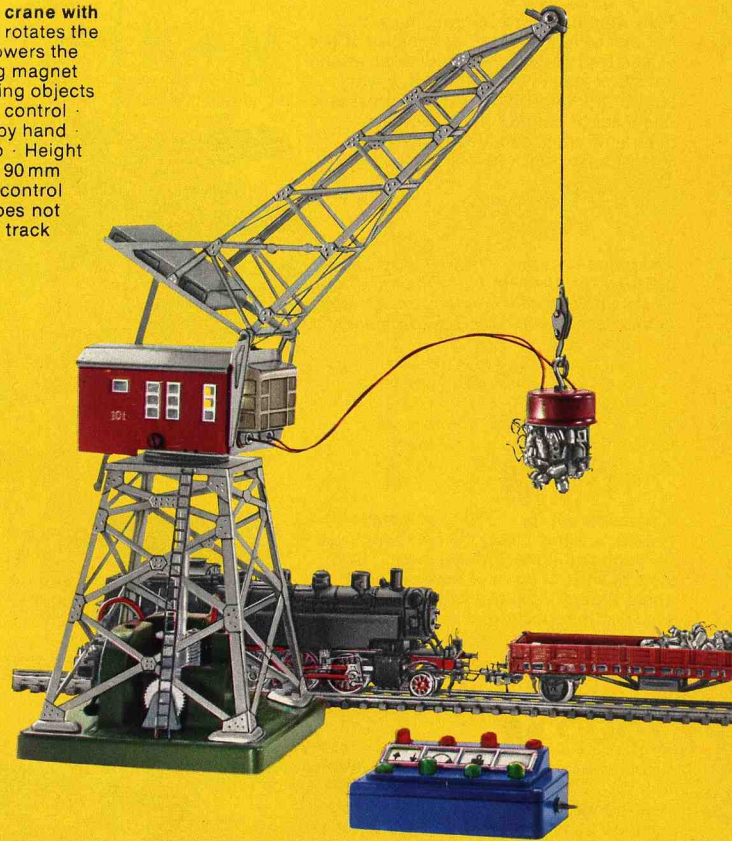
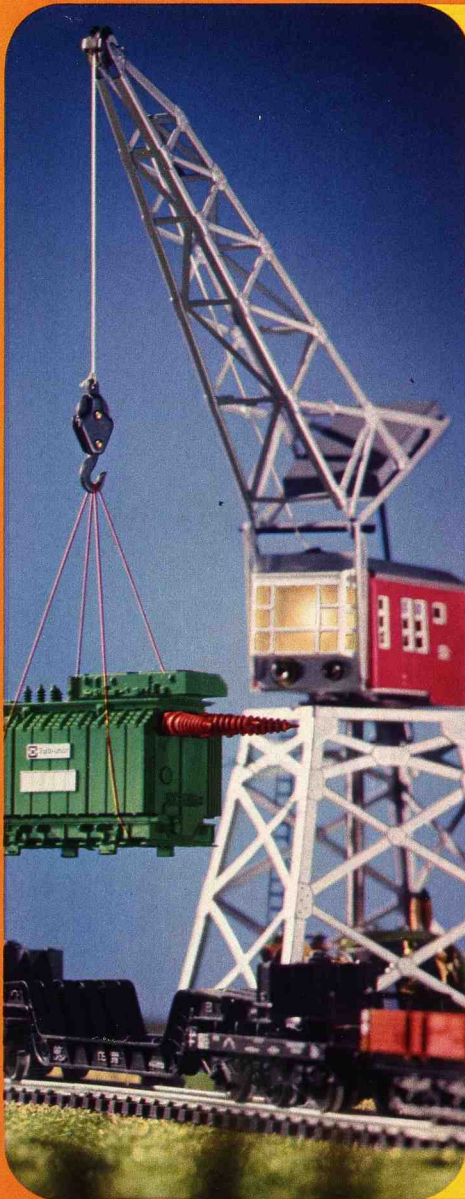

If you want to load and unload your trains properly, you need this crane. The lifting magnet only attracts iron objects, of course. You are not confined to handling "scrap-metal" and "pig-iron" however. Screw a couple of small steel screws inconspicuously into pieces of wood representing freight, and everyone will be surprised to see the

magnet lift a wooden box or crate out of a truck onto a freight car. A rotating crane not only introduces new, interesting variations into the operation of a model railroad, since all the operations can be remotely controlled, but it also adds realism to the whole transport process.

Grade-crossing for K-tracks

7592K

Grade-crossing with half-barrier for K-tracks · The set consists of 2 solenoid-operated barriers, each with 2 red warning lights which come on when the barriers close, and a set of contact track sections (1¹/₂ straight track sections long) · Size of base: 137 × 95 mm (5³/₈"' × 3³/₄"')
 Ⓞ = 60201

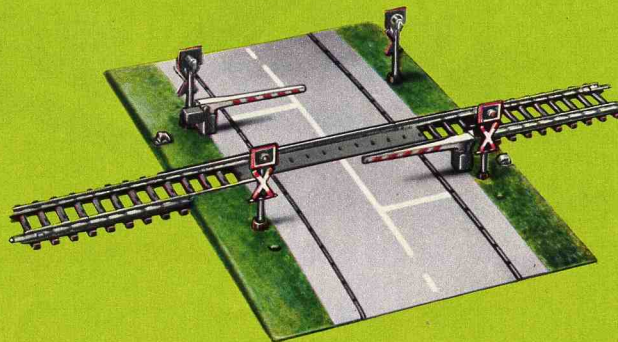

7593K

Extension set for grade-crossing 7592 · One is required for each additional parallel track · Consists of a set of contact track sections (1¹/₂ straight track sections long) and a separation piece, adjustable between 43 (1³/₄"') and 78 mm (3¹/₁₆"'), which is placed between the two tracks

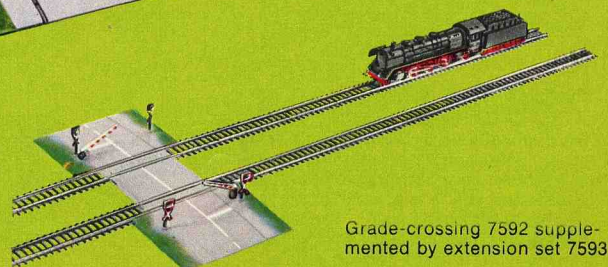
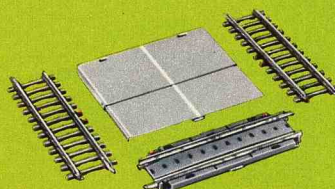

Grade-crossing 7592 supplemented by extension set 7593

Grade-crossings for M-tracks

7192 M

Fully automatic grade-crossing with M-track sections. The set consists of two solenoid-operated barriers with an attendant's box (capable of being fitted with interior lighting 7073), warning crosses and a set of contact track sections (2 straight track sections long). Size of base: 180×90 mm (7"×3½")

The grade-crossing 7192 can also be adapted for use with more than one track by the addition of the extension set 7193. In this case, it still operates automatically.

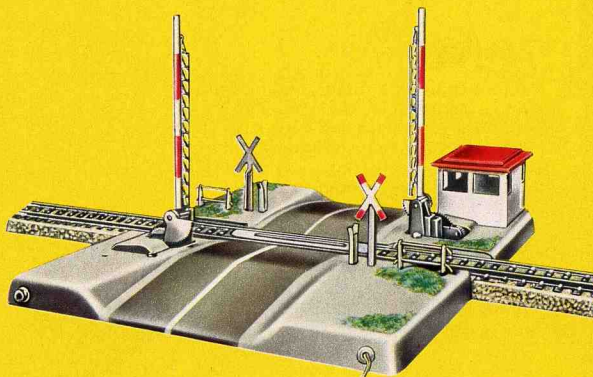

Contact track sections



5115 straight · Length 180 mm (7")



5116 curved · Radius 360 mm (1 ft. 2½")

*M-track sections 5115 and 5116 are for extending the contact sections of grade-crossings 7192 and 7292. The contact sections can be extended **only** with track sections 5115 and 5116.*

7193 M

Extension set for the fully automatic grade-crossing 7192, one being required for each additional parallel track. Consists of a set of contact track sections and a separating piece which is placed between the tracks

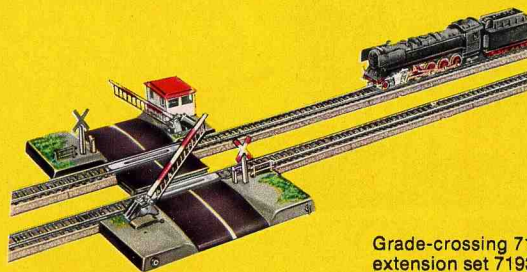
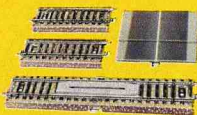

Grade-crossing 7192 supplemented by extension set 7193

7292 M

Grade-crossing with half-barriers for metal tracks. The set consists of two solenoid-operated barriers, each with two red warning lights which come on when the barriers close, and a set of contact track sections (1½ straight track sections long). Size of base: 137×95 mm (5⅜"×3¾")

Q = 60201

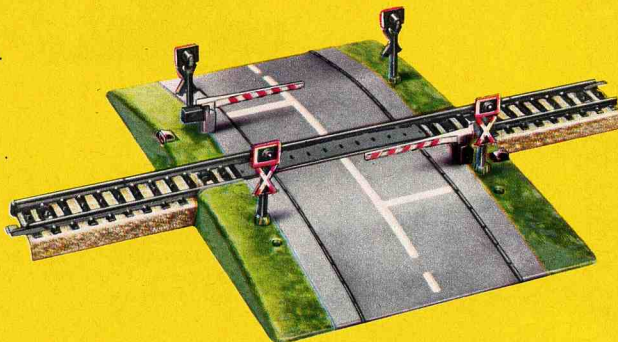

Guarded grade-crossings with automatic barriers. As soon as an approaching train runs on to the contact track sections the barriers close. They open again when the last of the rolling stock has cleared the contact section beyond the crossing.

7293 M

Extension set for grade-crossing 7292. One is required for each additional parallel track. Consists of a set of contact track sections (1½ straight track sections long) and a separating piece, adjustable between 43 (1¾") and 78 mm (3⅛"), which is placed between the two tracks

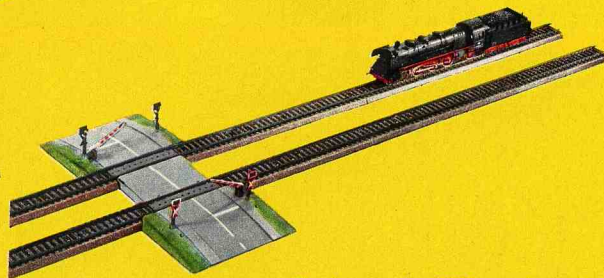
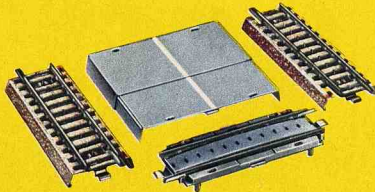

Grade-crossing 7292 supplemented by extension set 7293

7390 M

Mechanically operated grade-crossing for a single-track line, including a section of M-track. The barriers are operated by a lever arm which is pressed down by the wheels of a passing train. The length of the grade-crossing track section is the same as that of track section 5106. Base 135×180 mm (5⅜"×7")



Adapter track section 2191 (see page 60) enables K-tracks of the 2100 series to be connected to grade-crossings 7192 and 7390.

Bridges

Märklin bridges in plastic for K + M-tracks

With the Märklin bridge parts any size or combination of bridges or ramps can be built. The pier construction elements 7252 and 7253, which fit together like building blocks, enable piers of any height to be built up in steps of 6 mm (1/4"). By using base plate 7250 in conjunction with base plate 7251 in conjunction with base plate 7250 it is even possible to raise the height in steps of 3 mm (1/8"). For fixing the pier sections to each other and to the plate the use of flat-head wood screws 7599 is recommended.



7267 K + M
Curved ramp section · Gray · Radius of curvature 360 mm (1 ft. 2 1/8") · For use with plastic or metal tracks · 3 clips for fixing K-tracks · Length and radius as for track sections 2121 and 5100

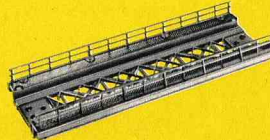

7268 K + M
Straight ramp section · Gray · For use with plastic or metal tracks · 3 clips for fixing K-tracks · Length 180 mm (7")



7269 for M only
Curved ramp section · Gray · Radius of curvature 437.4 mm (1 ft. 5 1/8") · For use with 5200 series metal tracks only · Track curves through 30°



7262 K + M
Truss bridge · Gray · Can be used on its own or with arched bridge 7263 · For use with plastic or metal tracks · 3 clips for fixing the K-tracks, and instructions for building the bridge · Height 45 mm (1 3/4") · Length 180 mm (7")



7263 K + M
Arched bridge · Gray · For use with plastic or metal tracks · 6 clips for fixing the K-tracks and instructions for building the bridge · Maximum height 117 mm (4 1/2") · Length 360 mm (1 ft. 2 1/8")



7569 for K only
Curved ramp section · Gray · Radius of curvature 424.6 mm (1 ft. 4 3/4") · For use with plastic tracks only (standard circle II, see page 60) · 3 clips for fixing track sections · Length and radius as for track section 2131

Complete instructions for the assembly of bridges are included with bridges 7262 and 7263.

7234
Base plate · For fixing signal masts of the 7200 series to bridges

7250

Base plate · 2.5 mm (1/16") thick · Light brown · Can be used as foundation



7251

Base plate · 3 mm (1/8") thick · Light brown · Can only be used in conjunction with 7250



7252

Pier · 6 mm (1/4") high · Gray · Suitable for building ramps with 6 mm (1/4") rise from one pier to the next



7253

Pier · 30 mm (1 1/4") high · Gray



Examples of bridge and ramp construction

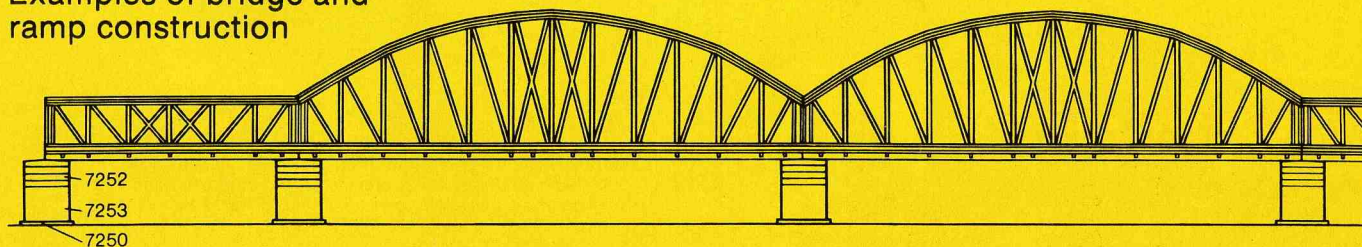

0	2,5 = 1 x 7250	5,5 = 1 x 7250 1 x 7251	11,5 = 1 x 7252 1 x 7250 1 x 7251	17,5 = 2 x 7252 1 x 7250 1 x 7251	23,5 = 3 x 7252 1 x 7250 1 x 7251
6 mm Steigung	Pfeilerhöhe bei M-Gleisen				
0	2,5 = 1 x 7250	2,5 = 1 x 7250	8,5 = 1 x 7252 1 x 7250	14,5 = 2 x 7252 1 x 7250	20,5 = 3 x 7252 1 x 7250
6 mm Steigung	Pfeilerhöhe bei K-Gleisen				
0	2,5 = 1 x 7250	5,5 = 1 x 7250 1 x 7251	11,5 = 1 x 7252 1 x 7250 1 x 7251	20,5 = 3 x 7252 1 x 7250	29,5 = 4 x 7252 1 x 7250 1 x 7251
9 mm Steigung	Pfeilerhöhe bei M-Gleisen				
0	2,5 = 1 x 7250	2,5 = 1 x 7250	8,5 = 1 x 7252 1 x 7250	17,5 = 2 x 7252 1 x 7250 1 x 7251	26,5 = 4 x 7252 1 x 7250
9 mm Steigung	Pfeilerhöhe bei K-Gleisen				

Electric lighting for trains

7197, 7320, 7325, 7326, 7327

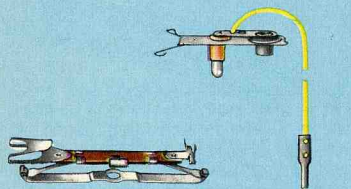
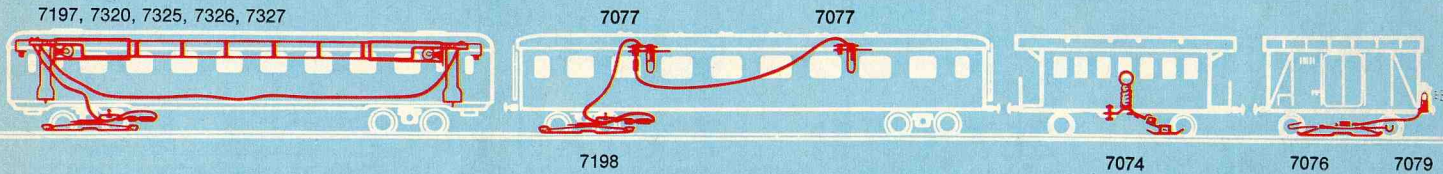

7076
Current pick-up shoe for taillight 7079 when used on passenger cars 4000, 4040 and on two-axle freight cars

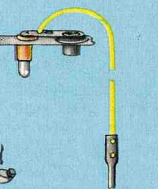

7077
Interior lighting set for most express coaches. With socket for connecting additional lighting sets. Light bulb
⚡ = 60000

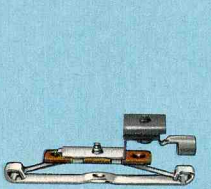

7198
Current pick-up shoe for interior lighting set 7077
⚡ = 7175



7079
Taillight including bulb. Clips onto buffer. For use on cars with metal buffers only. For connecting it up, 7074, 7076, 7077 or 7198 is required
⚡ = 60001 (red)

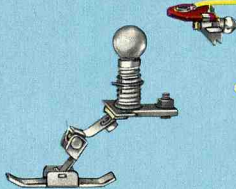

7074
Interior lighting set for passenger cars 4004, 4005, 4067, 4079 and 4080. With socket for connecting additional lighting sets. Light bulb
⚡ = 60020

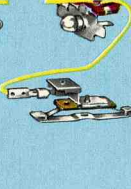

7322
Interior lighting set for the TEE coach 4090. Consists of current pick-up shoe 7198, 2 lamp sockets and 2 bulbs. Installation instructions are included
⚡ = 7175 ⚡ = 60015

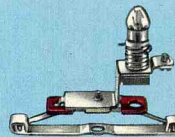

7323
Interior lighting set for coaches 4007 and 4008. Light bulb
⚡ = 7175 ⚡ = 60010

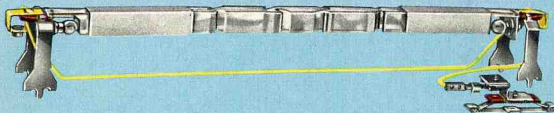

7197
Interior lighting set for express coaches 4072, 4073 and 4076. Consists of current pick-up shoe 7198, light diffuser, 2 lamp sockets and 2 bulbs. Installation instructions are included
⚡ = 7175 ⚡ = 60015

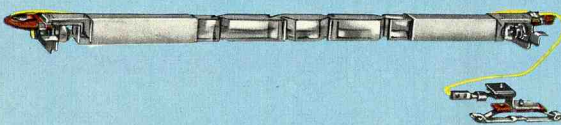

7320
Interior lighting set for TEE coaches 4085 and 4087 and for express coaches 4049, 4054, 4064, 4066 and 4069. Consists of current pick-up shoe 7198, light diffuser, 2 lamp sockets and 2 bulbs. Installation instructions are included
⚡ = 7175 ⚡ = 60015

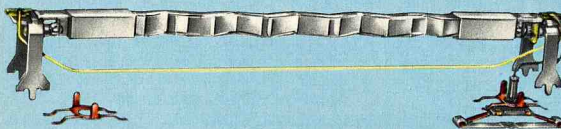

7325
Interior lighting set for express coaches 4091, 4092, 4093 and 4094 marked "A" on bottom of car, for TEE coaches 4095, 4096, 4097, 4099 and for express sleeping cars 4150 and 4151. Consists of current pick-up shoe, light diffuser, 2 lamp sockets and 2 bulbs. Installation instructions are included
⚡ = 41494 ⚡ = 60015

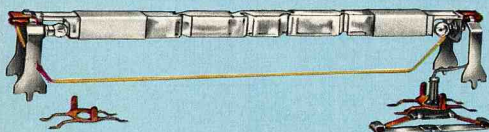

7326
Interior lighting set for express coaches 4135, 4136 and 4137. Consists of current pick-up shoe, light diffuser, 2 lamp sockets and 2 bulbs. Installation instructions are included
⚡ = 41494 ⚡ = 60015

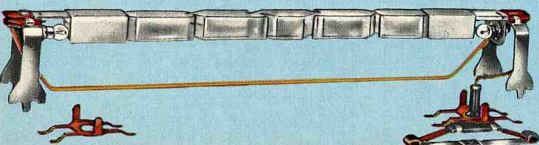

7327 *new*
Interior lighting set for express coaches 4139-4142. Consists of current pick-up shoe, light diffuser, 2 lamp sockets and 2 bulbs. Installation instructions are included
⚡ = 41494 ⚡ = 60015

Accessories

Light bulbs

for the following items

60000

2161, 3015, 4044, 4077, 4081, 5117, 5128, 5137, 5140, 5202, 7036, 7037, 7038, 7039, 7040, 7041, 7042, 7051, 7077, 7191, 7280, 7281, 7282, 7283, 7284

60001

3028, 3071, 3076, 3150, 4028, 7079, 7188, 7339, 7539 (red)

60002

7188, 7339, 7539 (green)

60010

3000, 3003, 3016, 3021, 3031, 3064, 3065, 3072, 3095, 4018, 4506, 5113, 7046, 7047, 7048, 7323

60015

3022, 3028, 3030, 3034, 3035, 3037, 3038, 3039, 3040, 3041, 3042, 3043, 3044, 3049, 3050, 3054, 3055, 3056, 3057, 3058, 3060, 3062, 3066, 3067, 3068, 3071, 3074, 3075, 3076, 3077, 3078, 3082, 3083, 3084, 3085, 3086, 3089, 3092, 3093, 3094, 3096, 3098, 3099, 3150, 4028, 4053, 4060, 4062, 4089, 6631, 7197, 7320, 7322, 7324, 7325, 7326, 7327

60020

7073, 7074

60200

7242

60201

7239, 7240, 7241, 7292, 7592 (red)

60202

7187, 7236, 7237, 7238, 7239, 7240, 7241 (green)

60204

7187, 7236, 7237, 7238, 7240, 7241 (orange)

Non-skid tires

for the following locomotives

7152

3083, 3085, 3086, 3089, 3092, 3093, 3094, 3098, 3099

7153

3003, 3015, 3016, 3022, 3030, 3034, 3035, 3037, 3038, 3039, 3040, 3041, 3042, 3043, 3049, 3050, 3054, 3056, 3057, 3058, 3064, 3065, 3082, 3084, 3095, 3096

7154

3000, 3021, 3028, 3031, 3044, 3055, 3060, 3062, 3066, 3067, 3068, 3071, 3072, 3074, 3075, 3076, 3077, 3078, 3080, 3087, 3090, 3150

Current pick-up shoes

for the following locomotives, cars and lighting sets

7164

3016, 3022, 3028, 3034, 3035, 3037, 3038, 3039, 3040, 3041, 3042, 3043, 3050, 3054, 3055, 3056, 3057, 3058, 3066, 3067, 3068, 3071 front, 3072, 3074, 3075, 3076, 3077, 3082, 3084, 3085, 3096, 3150, 4028

7175

3015, 3071 rear, 3150, 4018, 4044, 4053, 4077, 4081, 4089, 7197, 7198, 7320, 7322, 7323, 7324

7183

3021

7185

3000, 3003, 3030, 3031, 3044, 3049, 3060, 3062, 3064, 3065, 3078, 3080, 3083, 3086, 3087, 3089, 3090, 3092, 3093, 3094, 3095, 3098, 3099, 4060, 4062

Reverser unit springs

7194

Pack with 5 springs for reversing switches

Instructions for fitting non-skid tires, current pick-up shoes, light bulbs and reverser unit springs will be found in the "instructions for use".

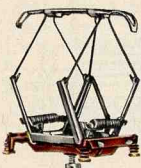

7218

Pantograph current collector with fixing screw



7219

Single bar current collector with fixing screw. The catenary system must be very carefully set up when 7219 is used



60030

Pair of carbon brushes for most HO gauge locomotives

60035

Pair of carbon brushes for locomotive 3015

60146

Pair of carbon brushes for locomotives 3034, 3035, 3037, 3038, 3039, 3042, 3049, 3056, 3057, 3058, 3082, 3084 and 3085

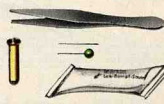

7226

Smoke set. Consisting of smoke unit (to fit locomotives 3082, 3084 and 3085), substitute steam pipe, cleaning wire, pair of tweezers and a capsule of smoke fluid



7227

Smoke set. Consisting of smoke unit (to fit locomotives 3083, 3092 and 3093) and a capsule of smoke fluid



0241

Smoke fluid in plastic capsule as refill for smoke sets 7226 and 7227



7199

Bottle of oil. Contains about 10 cc lubricating oil for locomotives and cars

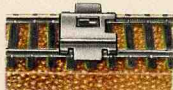

7001

Coupling gauge made of nickel-plated steel sheet for checking locomotive and car couplings



7195

Number plate set. For identifying turnouts and signals on the track layout. Contents: 12 slotted bases, number plates 1-24 which can fit in the slots

7224

Re-railing device. Made of plastic. Makes it easier to set multi-axle vehicles on the track. Length 300 mm (1 ft.). Height 25 mm (1")

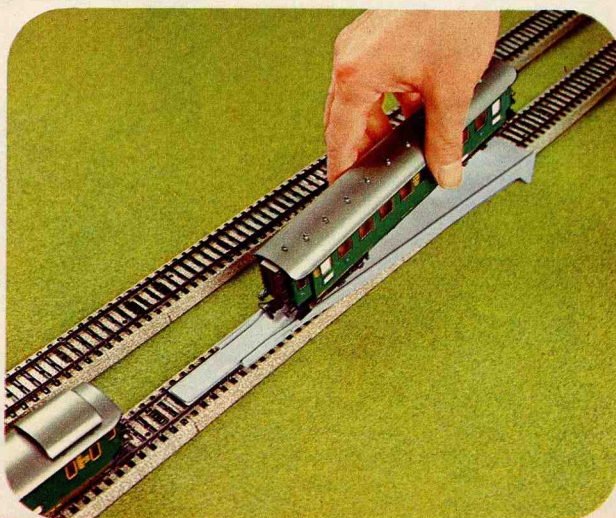

How the different Märklin M-track circles compare

This diagram shows the three Märklin M-track circles, with their radii, distances apart from each other, and curvatures, and also the number of track sections comprising a semicircle (Fig. 1).
 1 circle 5200 = 12 track sections
 1 circle 5100 = 12 track sections
 1 circle 5120 = 8 track sections

Concentric circles

Concentric circles can be constructed by using track sections of the 5100 and 5200 series. This gives a distance between track centers of 77.4 mm ($3\frac{1}{16}$ "') (measured from contact stud to contact stud) and a clearance between tracks of 39 mm ($1\frac{1}{2}$ "'). The turnouts 5202, 5221 or 5140 are used to cross from the inner to the outer loop (Fig. 2).

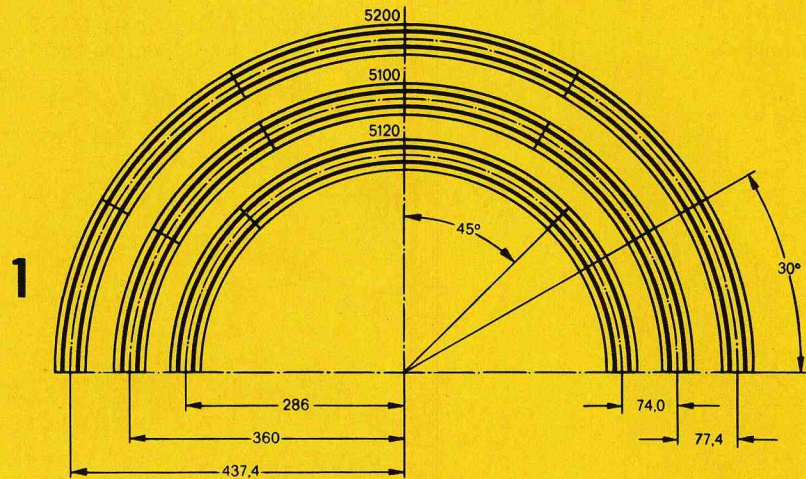

M-turnouts and their use

The electromagnetic turnouts 5137, 5140 and 5202 and the double slip switches 5128 and 5207 are operated by double solenoids. If a vehicle approaches the turnout from the wrong direction, its wheels open up the closure rail, so that derailment does not take place. The turnouts return automatically to their initial setting. Further turnouts can be joined directly on to either end of a turnout section.

Branches using 5100 series turnouts

When track section 5100 is fitted as a reverse curve onto the branch track of turnout 5137, the resulting distance between track centers is 96.4 mm ($3\frac{3}{4}$ "'). With the through track extended by track section 5106, the two branches have exactly the same length. Length of this assembly is 2×180 mm ($7\frac{1}{2}$ "') = 360 mm (1 ft. $2\frac{1}{8}$ "'), i.e. the same as 2 track sections 5106 (Fig. 3).

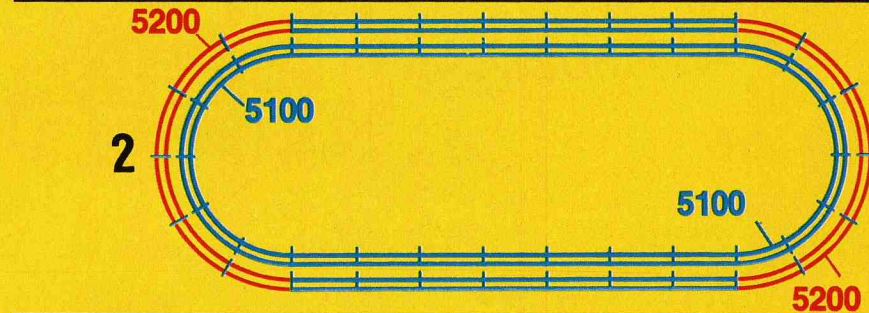

Branching of a parallel track section using turnouts 5137 (Fig. 4).

When the track sections supplied are used as reverse curves the distance between track centers is reduced from 96.4 mm ($3\frac{3}{4}$ "') to 54.8 mm ($2\frac{1}{8}$ "') (Fig. 5).

If the tracks of a 3- or more track layout are to be interconnected, retaining the 96.4 mm ($3\frac{3}{4}$ "') distance between track centers it is necessary to use crossing 5114 or double slip switch 5128. The double slip switch has the advantage that a train directed by a turnout on one of the outer tracks can be switched onto the center track. The simple crossing interconnects only the two outer tracks and does not enable transfer to the inner track (Fig. 6).

Märklin curved turnouts 5140
 These turnouts were developed to enable track interconnections to be made on the curve, hence saving space. Close examination of the diagram will show that a standard circle track section (5100) is fitted to the single track end of each curved turnout, even when this lies on the large concentric circle. In other words, the longer track section 5200 of the large concentric circle is not used, as with this the track center separation of 77.4 mm ($3\frac{1}{16}$ "') and the coincidence of the track section joints would be lost. The curved turnouts can be used to interconnect the standard circle only with the large concentric circle (Fig. 7).

Branch using a curved turnout 5140 (Fig. 8).

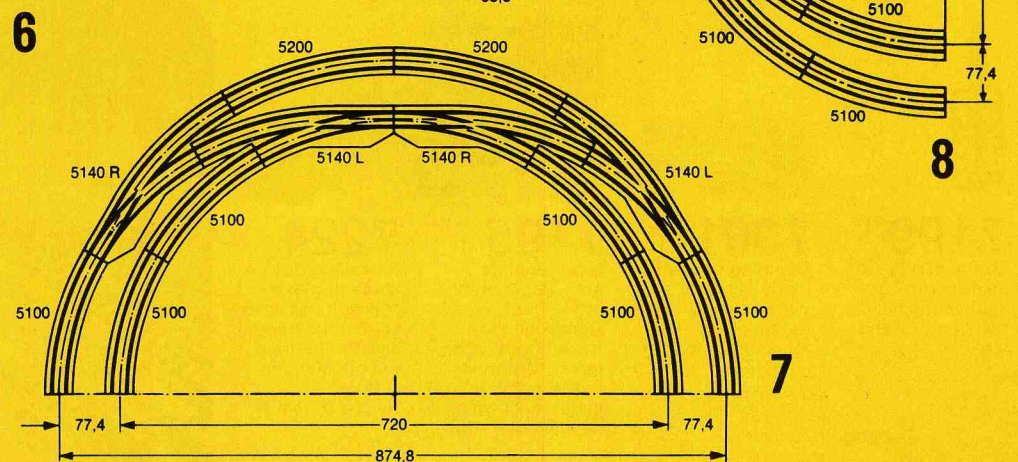
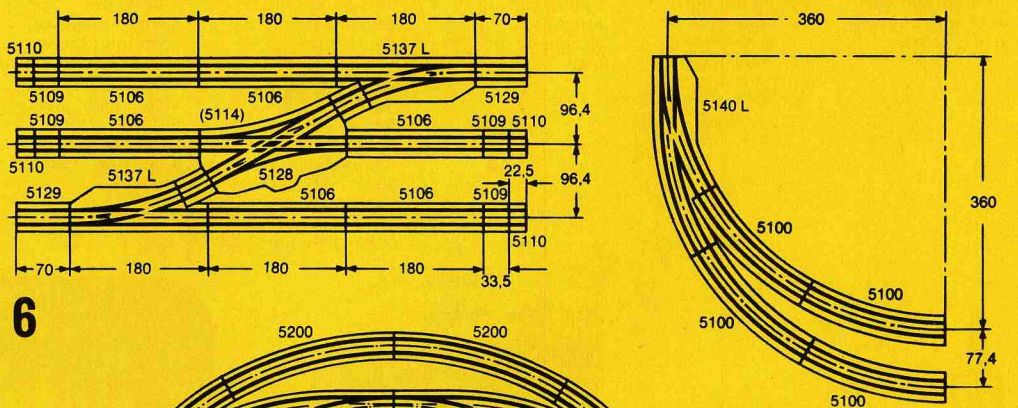
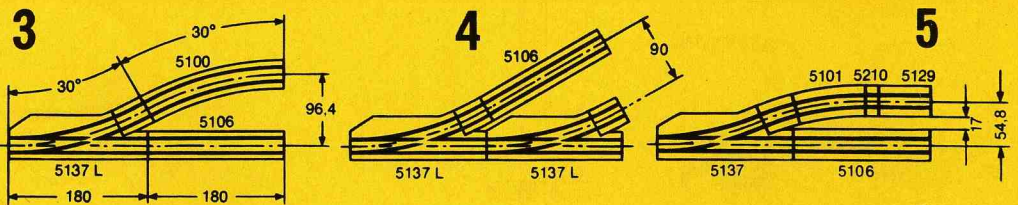

Features of the M-track (M = metal track body)

Here we show our proven metal track. The special feature of this track is the covered current feeder in the roadbed, with its stud contacts which project upwards in the center of the track through the cross-ties. The long pick-up shoes between the locomotive wheels slide over these contacts. Each track section

consists of the roadbed, which looks very realistic with its rock ballast and strong cross-ties and the two rails, which are electrically connected to the roadbed. Each rail has one jointing clip, at opposite ends of the track section.

typical of the Märklin system combined with good mechanical rigidity of the assembled layout.

The screws needed for mounting the track using sound-absorbent strips 7171 (see page 59) are included in the pack. For track mounting without sound absorbent strips we recommend the use of screws 7299 (see page 59).

The current feeder has spring contact tongues at each end. These lock together when the track sections are joined. At the same time the jointing clips slide onto the rails. The result is the solid electrical connection

Branches using turnouts 5200

Track section 5206 is used as the reverse curve for turnouts 5202. The distance between track centers is 77.4 mm ($3\frac{1}{16}$ "'), the same as the distance between the standard and the large concentric circles. If the through track is extended by track section 5106, it terminates in line with the end of track section 5206 (Fig. 9).

Branching of a parallel track section using turnouts 5202 (Fig. 10).

Parallel track sections with turnouts 5202 (Fig. 11).

If the tracks of a 3- or more track layout are to be interconnected, retaining the 77.4 mm ($3\frac{1}{16}$ "') distance between the centers of the normal circle and the large concentric circle tracks, the double slip switch 5207 is required. An advantage of this double slip switch is that the straight sections are exactly the same length as straight track sections 5106. But note that the diagonally running track of the double slip switch 5207 must be made up using the track sections 5208, 8 mm ($\frac{5}{16}$ "') in length (Fig. 12). These are supplied with 5207.

Interconnection of parallel tracks (Fig. 13).

Märklin three-way turnout 5214

In the Märklin three-way turnout 5214, two simple turnouts 5202 are combined, the unit being the same length as a turnout 5202 and hence the same length as a straight track section 5106 (full length: 180 mm/ $7\frac{1}{8}$ "'). The three-way turnout can thus save a lot of space, which can be particularly helpful in station tracks and in groups of crossings (Fig. 14).

This figure shows how the Märklin three-way turnout enables a main track and 4 branch tracks to be formed in the least possible space (Fig. 15).

Track branching using three-way turnouts (Fig. 16).

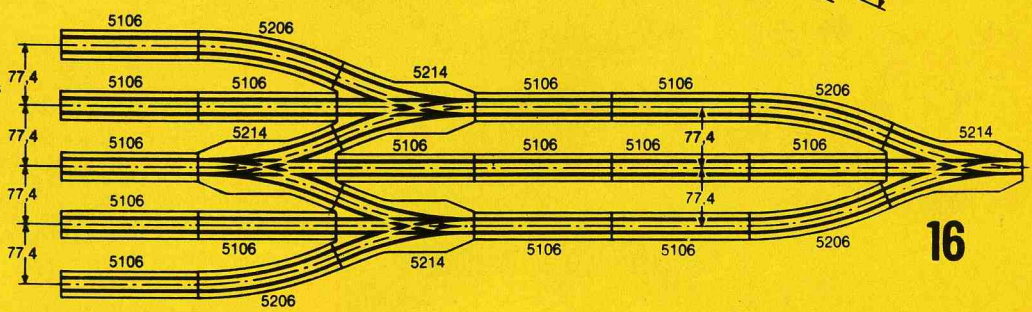
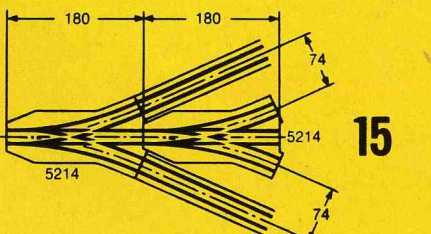
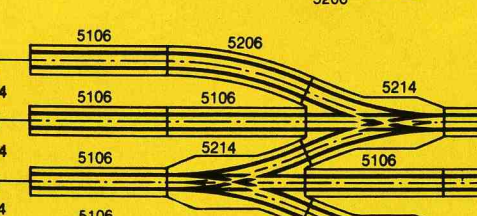
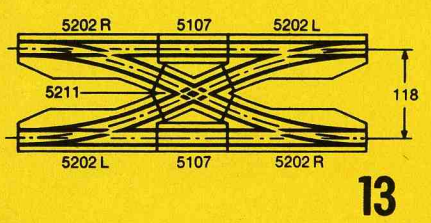
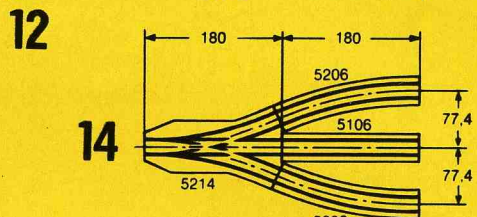
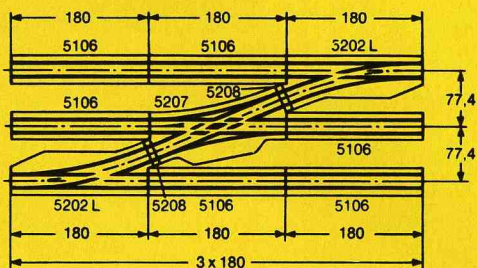
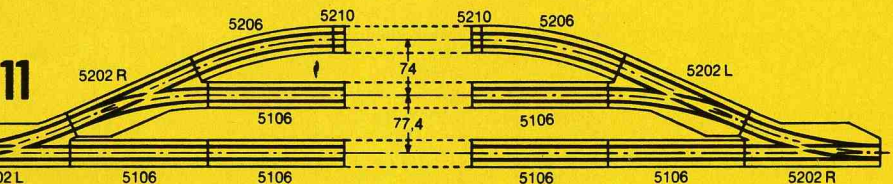
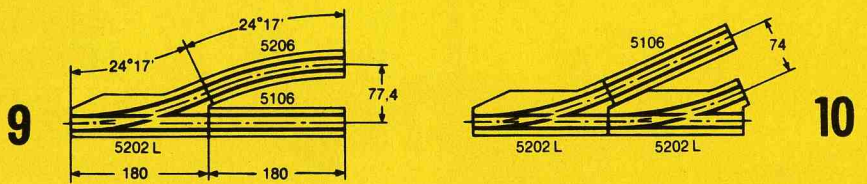

Summary of examples of use of Märklin M-turnouts (Fig. 17)

You will find further examples of possible combinations and methods of use in publication 0392, "HO gauge layouts for M-tracks 5100/5200" (see page 70).

Four solenoid-operated turnouts can be connected to one control box (see page 68).

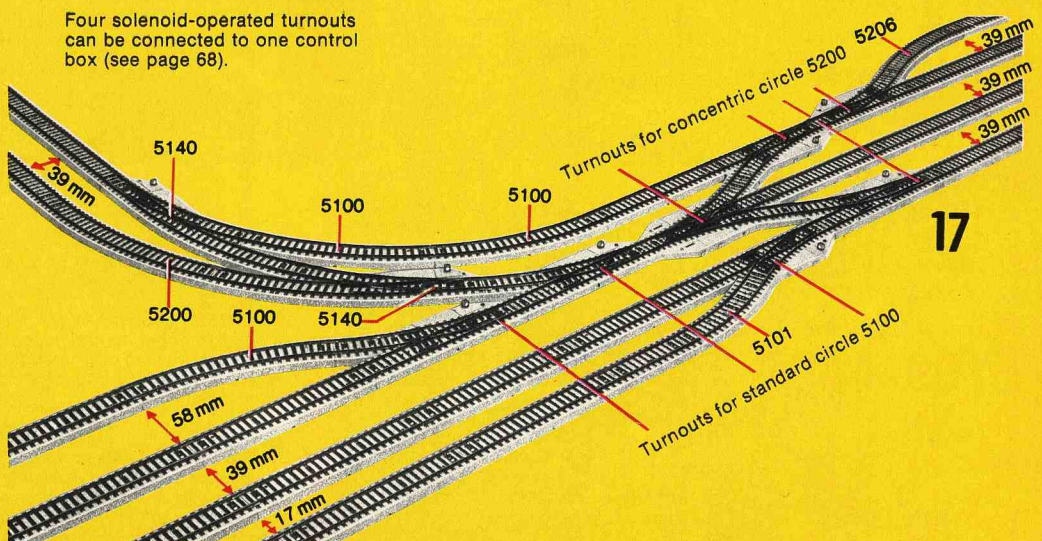

Curved track sections 5100 for standard circle

Twelve 5100 track sections make up a circle with an outside diameter of 76 cm (2 ft. 6").



5100 Full length = 30°



5101 Half length = 15°



5102 Quarter length = 7° 30'

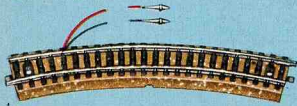

5103 Curved feeder track section · Full length = 30° · 2 connecting leads



5147 Curved switching track section · Half length = 15°

Switching track sections

Switching track sections (5146, 5147, 5213) can be used to control one operation in each direction of travel—i.e. two altogether. Each operation may apply to one solenoid-operated item or to several simultaneously. The switching track sections are triggered by the current pick-up shoes on locomotives or cars.



5120 Small radius track for branch lines and industrial railroads (for short vehicles only)

Curved track section · Full length = 45° · 8 track sections make up a circle with an outside diameter of 61 cm (2 ft.)

Curved track sections 5200 for large concentric circle

Twelve 5200 track sections make up a circle with an outside diameter of 91.2 cm (3 ft.).



5200 Full length = 30°



5206 Length = 24° 17' · Matches the curve of turnouts 5202 and 5221



5201 Half length = 15°



5205 Length = 5° 43' · This section, used with section 5206, equals track section 5200



5213 Curved switching track section · For concentric circle · Half length = 15° · Assembly and use as for 5146 and 5147



5208 Straight make-up section · Length 8 mm (5/16")



5210 Straight make-up section · Length 16 mm (5/8")



5211 Crossing · Crossing angle 48 1/2° · Length 98 mm (3 7/8") · The center conductors of the crossing are electrically isolated from each other

Straight track sections 5100



5106 Full length = 180 mm (7")



5107 Half length = 90 mm (3 1/2")



5129 Make-up section · Length 70 mm (2 3/4")



5108 Quarter length = 45 mm (1 3/4")



5109 3/16 length = 33.5 mm (1 1/8")



5110 1/8 length = 22.5 mm (7/8")

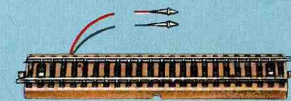

5111 Straight feeder track section · Full length = 180 mm (7") · 2 connecting leads

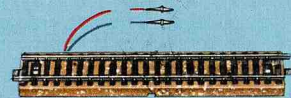

5131 Straight feeder track section · Full length = 180 mm (7") · Built-in radio interference suppressor · 2 connecting leads · One 5131 should be used for each traction current circuit



5146 Straight switching track section · Half length = 90 mm (3 1/2")

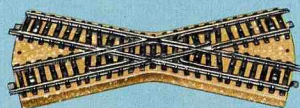

5114 Crossing · Length 193 mm (7 5/8") = 30° · The center conductors of the crossing are electrically isolated from each other

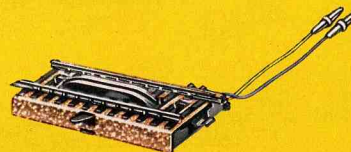

5112 Uncoupling track section for releasing automatic couplings · When the button on the control box is pressed, the solenoid-operated ramps on either side of the stud contacts are raised, releasing the couplings · 2 connecting leads · Length of track 90 mm (3 1/2")



5113 Light standard to go with the uncoupling track section · Die cast zinc · The light shows while uncoupling is in process · Height 85 mm (3 1/3") · Ø = 60010

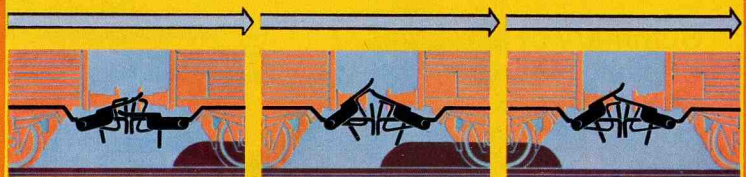

The coupling is opened by raising the ramp.

The RELEX coupling is designed to stay open after uncoupling, enabling cars to be pushed or dropped off at any desired point without the coupling closing again.

Railroading can only become really true to life when cars no longer have to be uncoupled manually from one another or from locomotives. This can be achieved by the use of uncoupling track sections, with their

light standards which indicate when the uncoupler is being operated. That not only looks right, it makes uncoupling easier too. When the coupling concerned, whether locomotive/car or car/car, is next to the signal standard, press the appropriate button on the control box once and the coupling will open, leaving the disconnected car or section of the train standing still. Cars with the advance uncoupler (RELEX) can then be pushed back again by the locomotive under remote control without the coupling closing.

M(=metal)-turnouts and accessories

Märklin M-turnouts 5100 and 5200 with sprung points

with double solenoid operation for remote control

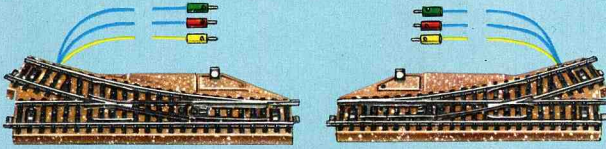

5202

Pair of solenoid-operated turnouts · Consisting of one right-hand and one left-hand turnout · Each with double solenoid · Working signal lights ·

The track lengths are the same as those of track sections 5206 and 5106
 Ⓞ = 60000



5221

Pair of manually-operated turnouts · Track dimensions as for 5202



5140

Pair of solenoid-operated curved turnouts · Consisting of one right-hand and one left-hand inside curve turnout, each operated by double solenoid · Working signal lights · Length and curvature of tracks as for track section 5100 · Length of through track 265.4 mm (10 1/2")
 Ⓞ = 60000

If curved turnouts are included in the layout, trains can be switched from one track to another while still on the curve. The narrow interval (77.4 mm) (3 1/8") between the parallel curves of the track is maintained and the saving in space makes a longer overtaking section possible.



5137

Pair of solenoid-operated turnouts · Consisting of one right-hand and one left-hand turnout, each operated by double solenoid · Working signal lights · Lengths of the straight section

180 mm (7") · Radius of branch track 360 mm (1 ft. 2 1/8") · Can be supplemented by the track section 5102 supplied, to equal section 5100
 Ⓞ = 60000

5128

Double slip switch · Crossing angle 30° · Operated by double solenoid · Working electric signal lights which change to indicate the setting of the points (crossing or curve) · Hand lever to permit manual setting · Length of straight section 193 mm (7 1/2") · The curve is the same as for track section 5100
 Ⓞ = 60000

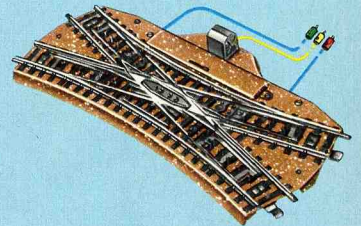

5207

Double slip switch · Enables the track spacing of 77.4 mm (3 1/8") to be maintained · Operated by double solenoid · Hand operating lever on actuator case · Length of straight section 180 mm (7") · The curve is the same as for 5202, 5221 and 5206 · 2 make-up sections 5208, each 8 mm (5/16") long, are included

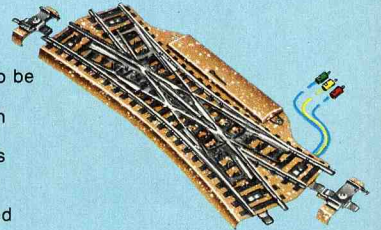

5214

Symmetrical three-way turnout operated by 2 double solenoids · 2 hand levers for manual setting of the two pairs of points · 5 connecting leads · Length of straight section 180 mm (7") · Radius of the branch tracks 437.4 mm (1 ft. 5 1/8"), the same as for the concentric circle · When used in conjunction with track section 5206, the 77.4 mm (3 1/8") track center spacing can be maintained on both sides

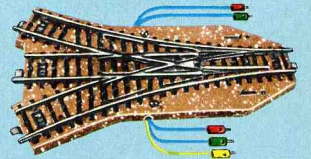

7190

Bumper, riveted steel type · Clipped on to 70 mm (2 3/4") long track section

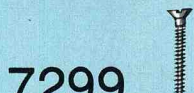

7299

Countersunk wood screws for mounting metal tracks · In packs of 200



7171

Sound absorbent strips in packs of 50 with 50 countersunk wood screws, for quiet train operation · If the track is laid out on a plywood board, the trains naturally make a certain amount of noise, though not excessive, as they move, to the rhythm of the wheels · If it is desired to damp this noise down to about half, it is recommended that the tracks, turnouts and crossings should be laid on sound-absorbent strips · This makes no difference to the mounting of the catenary system

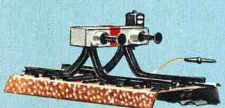

7191

Bumper, riveted steel type, with working signal light · Clipped on to 70 mm (2 3/4") long track section
 Ⓞ = 60000



0206

Track planning stencil for Märklin HO gauge M-track sections (series 5100/5200) · Track sections, turnouts, crossings etc. are marked out on the stencil in 1 : 10 scale, and with a sharp pencil they can easily be reproduced on paper

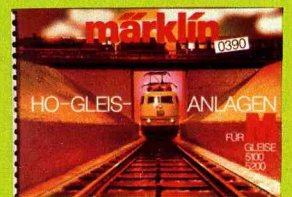

0392

Märklin track layouts, HO gauge, for M-tracks 5100 and 5200 · With full-color illustrations and detailed track plans of 16 suggested layouts · 56 pages

A full description of these booklets appears on page 70

Märklin K-tracks 2100 (K=plastic ties)

The stud-contact system, of which the advantages were described on page 57, is also used in the Märklin 2100 series K-tracks. With this track the rails are laid on plastic cross-ties. The stud-contacts project through the ties from below, ensuring very reliable current pick-up. The six-fold connection between one track section and the next comprises rail jointing clips, sprung connectors for the center conductor and an additional claw coupling on the cross-tie. Countersunk wood screws 7599

(see page 61) are recommended for fixing the K-tracks to a base.

The five Märklin K-track circles are:

- 1 industrial circle 2110 = 8 track sections
- 1 standard circle I 2121 = 12 track sections
- 1 standard circle II 2131 = 12 track sections
- 1 large circle I 2141 = 12 track sections
- 1 large circle II 2151 = 12 track sections

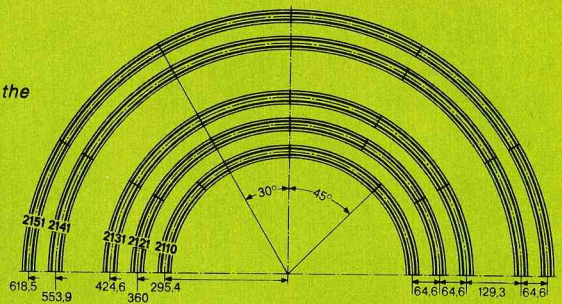

Straight track sections



2100 Full length = 180 mm (7")



2101 Half length = 90 mm (3 1/2")



2102 Quarter length = 45 mm (1 3/4")



2104 1/8 length = 22.5 mm (7/8")

Straight make-up sections

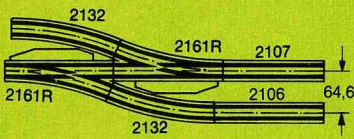

2190 Straight feeder track section · Full length = 180 mm (7") · 2 connector terminals marked "O" and "B" for connecting the track power lead



2106 Length = 168.9 mm (6 5/8")



2107 Length = 156 mm (6 1/8")

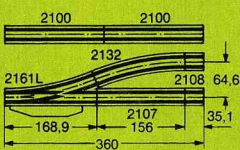

2108 Length = 35.1 mm (1 3/8")



2108 Length = 35.1 mm (1 3/8")



2158 Crossing · Crossing angle 45° · Length of straight sections 90 mm (3 1/2")



2159 Crossing · Crossing angle 22° 30' · Length of straight sections 168.9 mm (6 5/8")



2192 Straight feeder track section · Similar to 2190, but has in addition a built-in capacitor for radio interference suppression · One 2192 should be used for each traction current circuit



2191 Straight adapter track section · Full length = 180 mm (7") · Enables track sections of the 5100 and 5200 series to be connected to the 2100 series



2197 Uncoupler track section · Half length = 90 mm (3 1/2") · For releasing automatic couplings · Incorporates solenoids which permit the uncoupler ramp in the center of the track to be operated from the control box



2199 Straight switching track section · Half length = 90 mm (3 1/2")

Curved track sections

Radius 295.4 mm (11 5/8") · Industrial circle

Radius 424.6 mm (1 ft. 4 3/4") · Standard circle II

Small radius track for branch lines and industrial railroads (for short vehicles only)



2131 Full length = 30°



2110 Full length = 45°



2132 3/4 length = 22° 30'

Radius 360 mm (1 ft. 2 1/8") · Standard circle I



2121 Full length = 30°



2133 Half length = 15°



2123 Half length = 15°



2134 Quarter length = 7° 30'



2124 Quarter length = 7° 30'



2135 1/8 length = 3° 45'



2129 Curved switching track section · Half length = 15° · Radius 360 mm (1 ft. 2 1/8")



2139 Curved switching track section · Half length = 15° · Radius 424.6 mm (1 ft. 4 3/4")

Using the switching track sections (2129, 2139 or 2199) solenoid-operated items can be controlled automatically by a moving train. Each track section, activated by the train's pick-up shoe, can trigger two different and independent switch functions, depending on the direction of motion.

The control pulses are fed out via two terminals, isolated from each other.

Radius 553.9 mm (1 ft. 9 3/4") · Large circle I

Radius 618.5 mm (2 ft. 3/8") · Large circle II

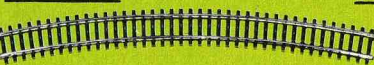

2141 Full length = 30°

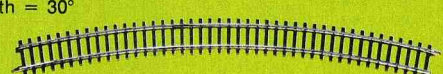

2151 Full length = 30°

K(=plastic)-turnouts and accessories

Märklin K-turnouts 2100 with sprung points



2161

Pair of solenoid-operated turnouts · Consisting of one right-hand and one left-hand turnout.



each operated by double solenoid · Working signal lights · Radius of branch track 424.6 mm (1 ft. 4³/₄"') · Length of straight track section 168.9 mm (6⁵/₈"') · $\varnothing = 60000$



2164

Pair of manually-operated turnouts · Consisting of one right-hand and one left-hand turnout ·



Radius of branch track 424.6 mm (1 ft. 4³/₄"') · Length of straight track section 168.9 mm (6⁵/₈"') · Operated by hand lever

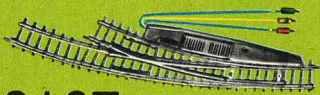

2167

Pair of curved solenoid-operated turnouts · Consisting of one right-hand and one left-hand inside turnout, each operated by double sole-

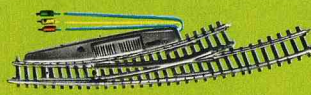

noid · Length and curvature of branch track are the same as for track section 2121 · Length of through track 244.6 mm (9⁵/₈"')

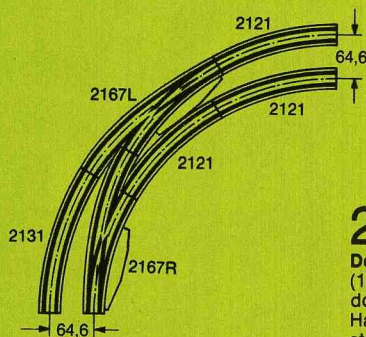

Example of use of 2167

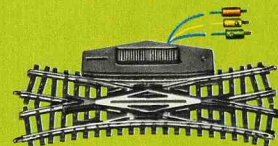

2160

Double slip switch · Radius 424.6 mm (1 ft. 4³/₄"') · Inside points operated by double solenoids under remote control · Hand lever in addition · Length of straight track sections 168.9 mm (6⁵/₈"')

2170

Symmetrical three-way turnout operated by 2 double solenoids · 2 hand levers for manual setting of the two pairs of points · Length of straight track section 168.9 mm (6⁵/₈"') · Radius of branch tracks 424.6 mm (1 ft. 4³/₄"')

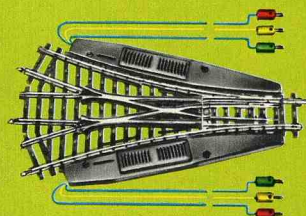

7391



Bumper, riveted steel type · For clipping on to the rails · Length 38 mm (1¹/₂"') · Oval-head countersunk wood screw included

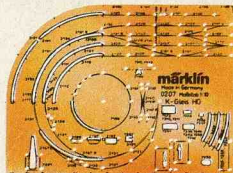

0207

Track planning stencil for Märklin K-tracks (2100 series), HO gauge · Track sections, turnouts, crossings etc are marked out on the stencil and can easily be reproduced on paper by using a sharp pencil

7500



Ground connector with terminal, for connecting the ground lead to 2100 series track sections

7504



Connector for center conductor with terminal · Is pushed onto the contact strips at the joint of 2100 series track sections



0372

Märklin track layouts, HO gauge, for 2100 series K-tracks · An outstanding guide · 52 pages

7522

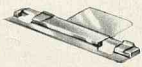

Center conductor isolator · Is fitted between the contact strips at the joint of 2100 series track sections, to separate the electrical circuits on each side



0379

Märklin track layouts, HO gauge, for 2100 series K-tracks · Simple track plans · 20 pages · For full description of these booklets see page 70

7599



Countersunk wood screws for fixing plastic tracks · In packs of 200

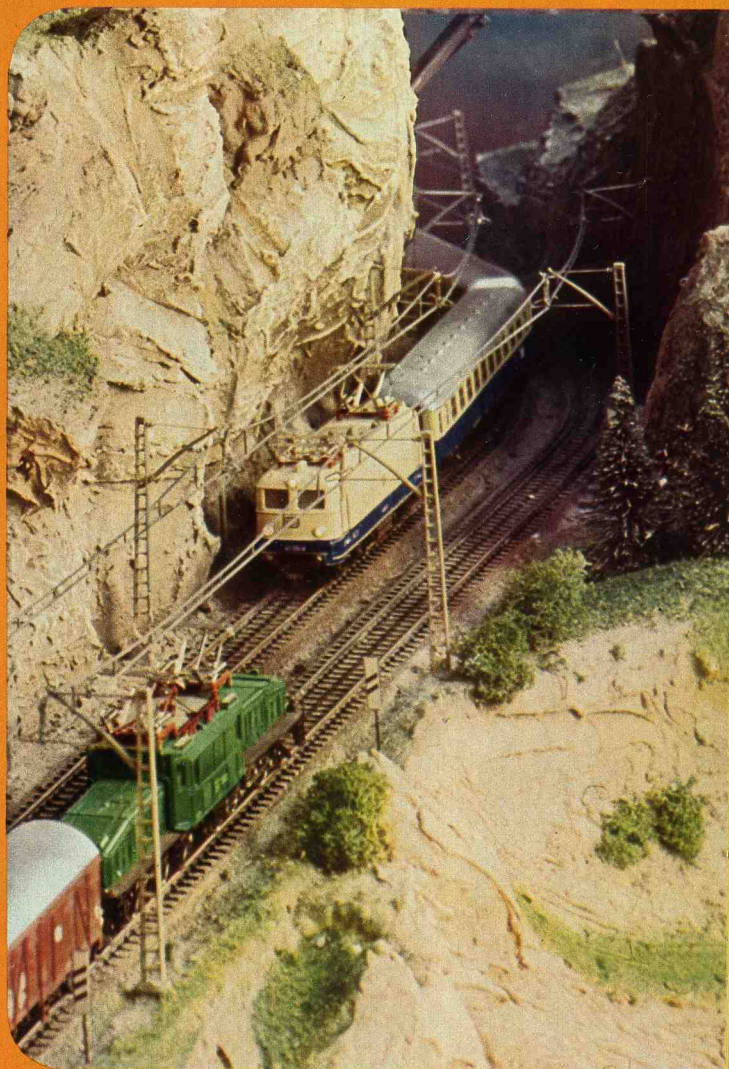

märklin
H0

Signals for M(=metal)-tracks

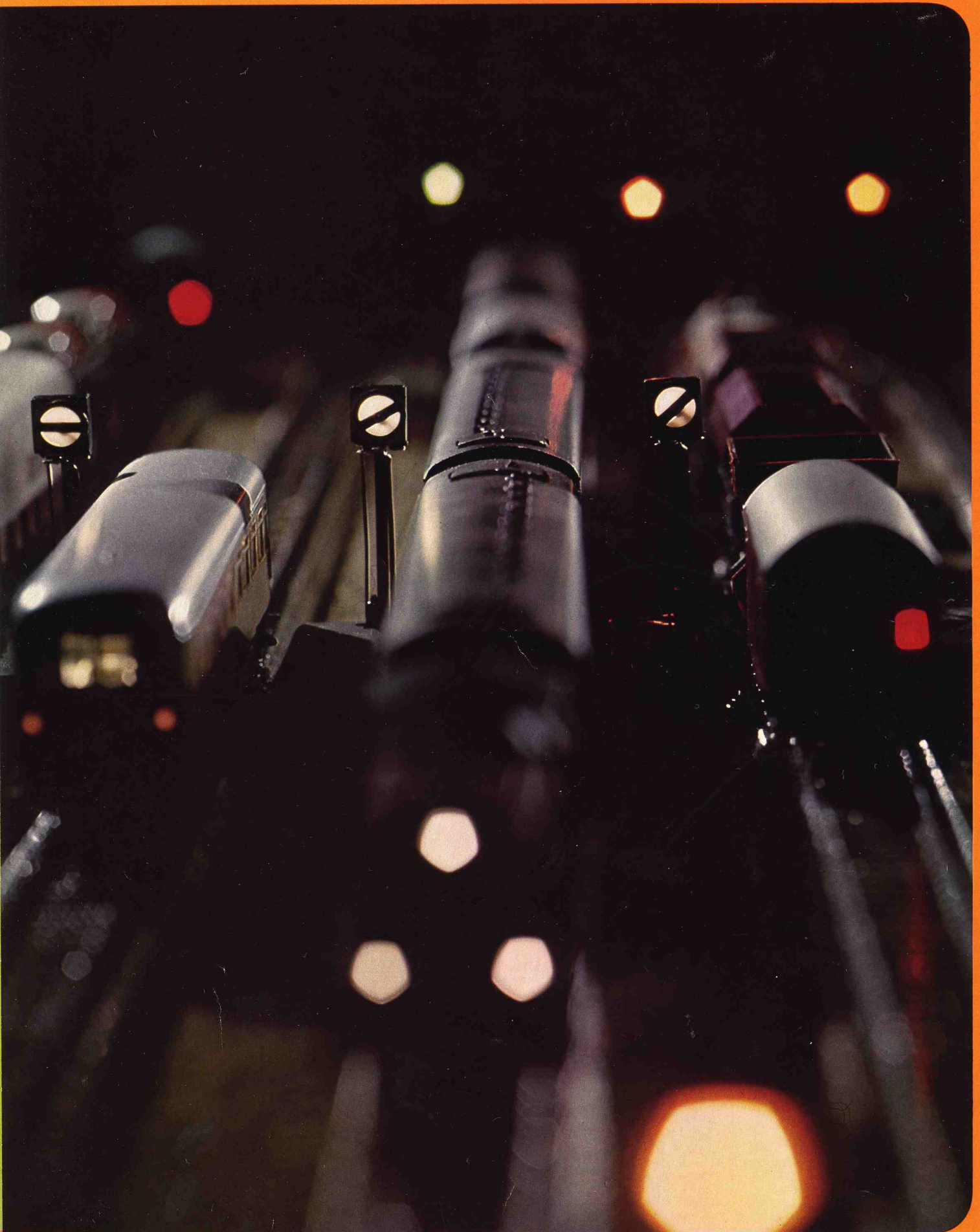

To make the railroad operation truly realistic

The Märklin range of signals for M-tracks

There should be a few suitably arranged signals, even on a small railroad layout, and not just because the play of red, green and amber lights looks so attractive. You can regulate the traffic by setting the signals to red and green, by remote control, and the signals can control the stopping and starting of the trains.

And that's not all: if you just include switching track sections and connect them to the signals, one train can control another automatically via the

signals without any chance of a collision (Block or high-density operation). In this way, while some trains travel in accordance with the program, you are free to see to other things, e.g. switching.

The installation of signals is simple. Their base plates are clamped under straight or curved metal track sections, and the leads are connected as shown in the instructions supplied. The signals are connected electrically to the control boxes (7072, see page 68) in such a way that it can be seen from the position of the push buttons whether the signals are at "stop" or "go".

Anyone who wants his layout to be realistic should install distant signals as well as the home signals described. They are mounted in the same way as home signals and are simply connected to them by a lead.

With one control box 7072 it is possible to operate, for example, 4 home signals 7039 together with their distant signals, and also groups of signals and turnouts.

Home and siding signals have traction current switches, which can be used to control the current in the track center conductor or overhead line.

The silver contacts in the switches enable them to cope with heavy loads.

The signal connector leads are fitted with color-coded plugs, which have side sockets for connecting a second plug. There are also sockets in the signal base for connection of the overhead line and grounding leads. Each pack includes small bulbs for the lighting system, insulators for the current conductor, a base plate and detailed installation instructions.

Distant signals without train control

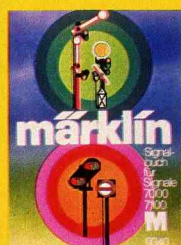

0342
Märklin signal manual for M-tracks · For detailed description see page 70

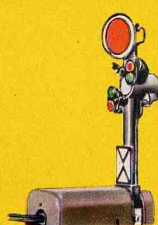

7036
Distant signal with movable disk · Signal lights change from amber/amber to green/green · Double solenoid · Used with home signal 7039 · Width 28 mm (1¹/₈"') · Length 65 mm (2⁹/₁₆"') · Height 73 mm (2⁷/₈"')
⊙ = 60000

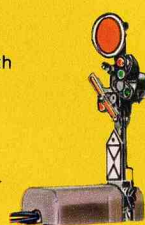

7038
Distant signal with movable disk and additional movable semaphore arm · Light sequence as for 7036 or from amber/amber to green · 2 double solenoids · Usually used with home signals 7040 or 7041 · Width 28 mm (1¹/₈"') · Length 65 mm (2⁹/₁₆"') · Height 73 mm (2⁷/₈"')
⊙ = 60000



7187
Color light distant signal · Used only in conjunction with color light home signal 7188 · Signal lights change from green/green to amber/amber using 4 bulbs · Width 16 mm (5/8)"') · Length 11 mm (7/16)"') · Height 60 mm (2³/₈"')
⊙ = 60202 green
60204 orange

Signals with train control for catenary and track supply systems



7245

Universal remote control switch with 2 single-pole switches and one changeover switch for various circuits · It can do many kinds of job (up to 3 functions simultaneously), and will carry them out reliably and automatically; for example it can cause a moving train to switch station lighting on and off, or it can override the control of trains by signals for trains traveling in the opposite direction, or many other things · Lots of possible applications are shown in the signal manual 0342 and in the installation instructions · Operated by double solenoid · Can be actuated by switching track section, control box or hand lever · Width 30 mm (1³/₈"') · Length 70 mm (2³/₄"') · Height 8 mm (5/16)"')



7039
Home signal with one semaphore arm · Signal light changes from red to green · Double solenoid · Width 27 mm (1¹/₈"') · Length 70 mm (2³/₄"') · Height 125 mm (5")
⊙ = 60000



7040
Home signal with 2 coupled semaphore arms · Signal lights change from red to green/amber · Double solenoid · Width 27 mm (1¹/₈"') · Length 70 mm (2³/₄"') · Height 125 mm (5")
⊙ = 60000



7041
Home signal with 2 independent semaphore arms · Signal lights change from red to green or red to green/amber · 3 solenoids · Width 27 mm (1¹/₈"') · Length 97 mm (3³/₄"') · Height 125 mm (5")
⊙ = 60000



7188
Color light home signal · Signal lights change from red to green · Double solenoid · Lighting by 2 bulbs · Additional hand control lever · Pair of sockets for connection of distant signal 7187 · Width 28 mm (1¹/₈"') · Length 70 mm (2³/₄"') · Height 90 mm (3¹/₂"')
⊙ = 60001 red
60002 green



7042
Yard and siding signal · Mast with movable front and rear disks · Double solenoid · Width 28 mm (1¹/₈"') · Length 70 mm (2³/₄"') · Height 70 mm (2³/₄"')
⊙ = 60000

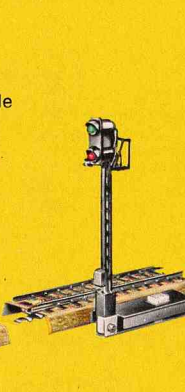

7339
Color light home signal · Signal lights change from red to green by manual operation, which at the same time controls the current to the section of metal track joined on to the signal · Additional track section 90 mm (3¹/₂"') long with interrupted central conductor · Width 55 mm (2¹/₈"') · Length 90 mm (3¹/₂"') · Height 90 mm (3¹/₂"')
⊙ = 60001 red
60002 green

Märklin signals 7200 for K+M-tracks

The color light home signals and siding signals of the 7200 series have switches which enable them to control traction current in the catenary system and the track center conductor independently. The signal masts, and the lighting unit of yard + siding signal 7242 can be separated from the traction current switch units and set up by themselves. The bracket 7230 is then required for fixing the masts. Ground connection is by the base plates or leads supplied, when used with 2100 series track sections, and via the leads when used with 5100 and 5200 series track sections.

7236

Color light distant signal · Signal lights change from amber/amber (Vr0) to green/green (Vr1) using 4 bulbs · Only used in conjunction with color light home signal 7239 · Includes fixing bracket 7230 and base plate · Width 16 mm ($\frac{5}{8}$ "') · Length 28 mm ($1\frac{1}{8}$ "') · Height 67 mm ($2\frac{5}{8}$ "')
 ⚪ = 60202 green
 ⚪ = 60204 orange

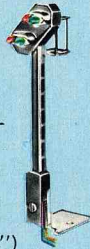

7237

Color light distant signal · Signal lights change from amber/amber (Vr0) to amber/green (Vr2) using 4 bulbs · Used only in conjunction with color light home signal 7240 · Includes fixing bracket 7230 and base plate · Width 16 mm ($\frac{5}{8}$ "') · Length 28 mm ($1\frac{1}{8}$ "') · Height 67 mm ($2\frac{5}{8}$ "')
 ⚪ = 60202 green
 ⚪ = 60204 orange

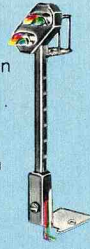

7238

Color light distant signal · Signal lights change from

amber/amber (Vr0) to green/green (Vr1) or amber/green (Vr2) using 4 bulbs · Double solenoid operation for the amber/green setting · For use with color light home signal 7241 · Includes base plate · Width 30 mm ($1\frac{3}{16}$ "') · Length 70 mm ($2\frac{3}{4}$ "') · Height 67 mm ($2\frac{5}{8}$ "')
 ⚪ = 60202 green
 ⚪ = 60204 orange

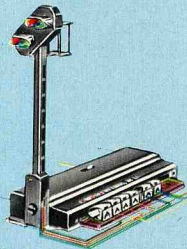

7239

Color light home signal · Signal lights change from red (Hp0) to green (Hp1), and traction current

controlled by double solenoid operation · 2 bulbs · Additional hand lever · Includes base plate · Width 30 mm ($1\frac{3}{16}$ "') · Length 70 mm ($2\frac{3}{4}$ "') · Height 90 mm ($3\frac{1}{2}$ "')
 ⚪ = 60201 red
 ⚪ = 60202 green

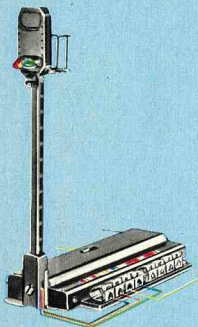

Center conductor isolators, center conductor connectors and instructions are included with home signals 7239, 7240 and 7241.

7240

Color light home signal · Signal lights change from red (Hp0) to green/amber (Hp2), and traction current

controlled by double solenoid operation · 3 bulbs · Additional hand lever · Includes base plate · Width 30 mm ($1\frac{3}{16}$ "') · Length 70 mm ($2\frac{3}{4}$ "') · Height 90 mm ($3\frac{1}{2}$ "')
 ⚪ = 60201 red
 ⚪ = 60202 green
 ⚪ = 60204 orange

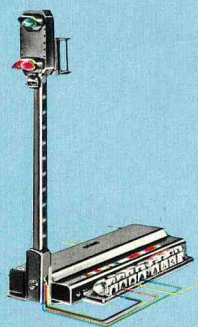

7241

Color light home signal · Signal lights change from red (Hp0) to green (Hp1) or green/amber (Hp2), and

traction current controlled by double solenoid operation with an additional solenoid for the green/amber setting · 3 bulbs · 2 hand control levers in addition · Includes base plate · Width 30 mm ($1\frac{3}{16}$ "') · Length 95 mm ($3\frac{3}{4}$ "') · Height 90 mm ($3\frac{1}{2}$ "')
 ⚪ = 60201 red
 ⚪ = 60202 green
 ⚪ = 60204 orange

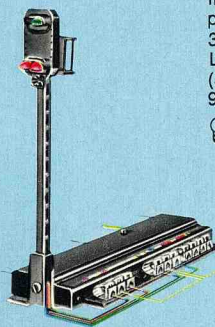

7230

Fixing bracket · Is required if the mast of light signals 7238, 7239, 7240, 7241 and the yard + siding signal 7242 are set up separated from the traction current control units



7242

Yard and siding signal, dwarf version · Signal lights change from red/red (Sh0) to white/white (Sh1) and traction current controlled by double solenoid operation · 2 lights bulbs provide the signal lights · Additional hand control lever · Width 30 mm ($1\frac{3}{16}$ "') · Length 70 mm ($2\frac{3}{4}$ "') · Height 18 mm ($\frac{3}{4}$ "')
 ⚪ = 60200

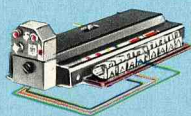

7245

Universal remote control switch with 2 single-pole switches and one change-over switch for various circuits · It can do many kinds of job (up to 3 functions simultaneously), and it will carry them out reliably and automatically; for example it can cause a moving train to switch station lighting on and off, or it can override the control of trains by signal for trains traveling in the opposite direction, or many other things · Lots of possible applications are shown in the signal manual 0361 and in the installation instructions · Operated by double box or hand lever · Width 30 mm ($1\frac{3}{16}$ "') · Length 70 mm ($2\frac{3}{4}$ "') · Height 8 mm ($\frac{5}{16}$ "')



0361

Märklin signal manual for K-tracks · For detailed description see page 70



Station and street lighting



7280
Street lamp standard · Height 117 mm (4⁵/₈"') · Base diameter 25 mm (1"')
☉ = 60000



7281
Station platform lamp standard · Twin armed · Height 97 mm (3³/₄"') · Base diameter 25 mm (1"')
☉ = 60000



7282
Street lamp standard · Twin armed · Height 120 mm (4³/₄"') · Base diameter 25 mm (1"')
☉ = 60000



7283
Lattice mast light · Mounted on a lattice mast · With base plates for mounting on tracks · Can be used with catenary system · Height 170 mm (6³/₄"')
☉ = 60000



7284
Sidewalk lamp standard · Height 63 mm (2¹/₂"') · Base diameter 15 mm (3/5"')
☉ = 60000



7046
Arc light with lattice mast · Can be used with catenary system for M-tracks · Height 192 mm (7⁵/₈"') · Base 14 x 28 mm (9/16"') x (1¹/₈"')
☉ = 60010



7047
Lamp standard · Height 127 mm (5"') · Base diameter 27 mm (1¹/₁₆"')
☉ = 60010

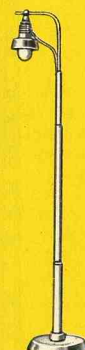

7048
Arc light · Height 156 mm (6¹/₈"') · Base diameter 29 mm (1¹/₈"')
☉ = 60010

Märklin catenary system for M-tracks 5100/5200



7009
Catenary mast ·
Basic element ·
Height 100 mm (4")

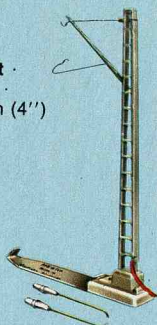

7010
Feeder mast
for supplying cur-
rent, with 2 leads
and including in-
structions for
using the catenary
system ·
Height 100 mm (4")

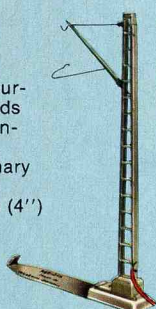

7012
Feeder mast
for signals, with
one lead ·
Height 100 mm (4")

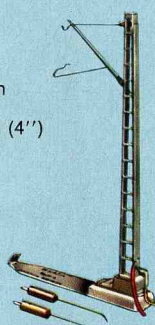

7201 Feeder mast for supplying current, with 2 permanently connected leads, one red, one brown · Additional brown lead · Built-in capacitor for radio interference suppression · One mast required for each electrical circuit · Instructions for setting up the catenary system are included · Height 100 mm (4")

7005 Catenary set for train control for signals of the 7000 series which are not mounted on tower masts · Consisting of 2 feeder masts 7012, 2 insulator sections 7022 and 2 overhead wire contact sections 7014

Electric locomotives can draw current from the overhead line with the same reliability and positive electrical contact as from the track center conductor stud contacts. On the locomotive, all that has to be done is to change over the position of a small lever. With the Märklin system, it makes no difference which way round the locomotive is put on the track. It's a good idea to connect the catenary system to a separate transformer, as two trains can then be run independently on the same track, one using the overhead line and one using the track stud contacts.

The overhead wires, with their tensioning and cross-span connectors are arranged exactly like the real thing. That is why the Märklin catenary system looks so realistic, spanning the open stretches of railroad and especially around stations. The contact wire sections can be used with both M-tracks and K-tracks. The sprung contact wire holders on the masts ensure reliable contact with the contact wires.

The push-fit connectors, on contact wire sections 7013 and 7023 for example, enable the contact wires to be slid together to make up the right length.

The contact wires are flexible and can adapt to any curve without the need for special fittings. The longest contact wire section 7019 was designed for use on long straight sections.

Using the tower masts 7021 and the cross-spans 7016 it is possible to span the widest of station or yard track complexes. For 4 tracks one cross-span and two tower masts are required, then one cross-span and one tower mast for every 4 additional tracks. For single tracks outside a pair of masts, the overhead line can be suspended from the cantilever support arm 7525.

Märklin catenary system for K+M-tracks



7021
Tower mast
with recesses for
hooking in cross-
spans 7016 or 7017
and the cantilever
support arm 7525
for the overhead
line · For tower
mast with arc light
see page 65 ·
Height with
M-tracks 157 mm
(6³/₁₆"') ·
Height with
K-tracks 154 mm
(6¹/₁₆"')



7511
Bridge mast ·
For attaching to
the side of plastic
bridges and ramp
sections · Height
97 mm (3⁷/₈"')



7003
Catenary system connector lead
for connection to signals when
tower masts are used, and for
supplying current to any point ·
Length 600 mm (1 ft. 11⁵/₈"')

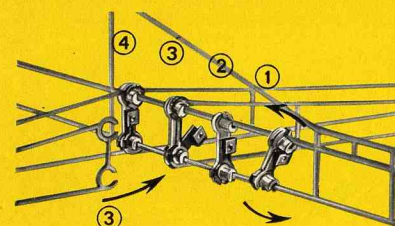

7004
Fastening kit · Consisting of
5 bolts, 5 nuts and 5 washers ·
Used only in exceptional cases
where it is not possible to make
a reliable contact by the usual
method of assembly

7006
Contact wire insu-
lation · For insu-
lating sections of
contact wire from
cross-spans · One
required for each
track and cross-
span · 15x6 mm
(⁵/₈"' x ¹/₄"')



7013
Contact wire section for push-fit connec-
tion, especially for use at turnouts ·
Length 240 mm (9¹/₂"')



7014
Contact wire section · Female
portion (for push-fit connection)
Length 115 mm (4¹/₂"')



7015
Contact wire section · Male portion
(for push-fit connection)
Length 115 mm (4¹/₂"')

All contact wire sections are nickel-plated.

For realistic operation of electric locomotives, and for operating two trains on one track

Märklin catenary system for K-tracks 2100

7509

Catenary mast · Basic unit for construction of a catenary system over track sections of the 2100 series · Height 97 mm (3⁷/₈"')



7510

Feeder mast with a red lead and plug attached to the mast · Brown lead with plug · Includes instructions for setting up the catenary system · Height 97 mm (3⁷/₈"')

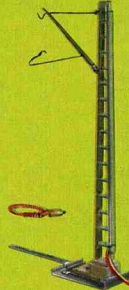

7512

Feeder mast with a red lead attached, for connecting the catenary system to the home signals · Height 97 mm (3⁷/₈"')

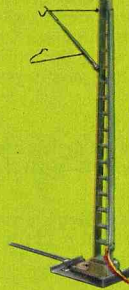

7501

Feeder mast with 2 permanently attached leads, one red, one brown · Built-in capacitor for radio interference suppression · One mast required for each electrical circuit · Instructions for setting up the catenary system are included · Height 97 mm (3⁷/₈"')



7505

Catenary set for train control for 7200 series color light home signals which are not mounted on tower masts · Consisting of 2 feeder masts 7512, 2 interrupted track sections 7022 and 2 contact wire sections 7014 · For use with 2100 series track sections

7525

Cantilever support arm for suspending single or double overhead contact wires, in conjunction with tower mast 7021 (see illustration)

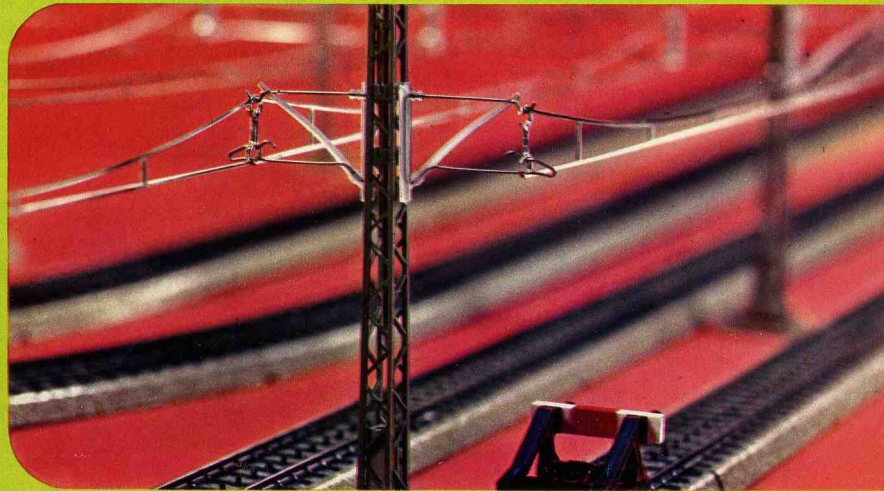
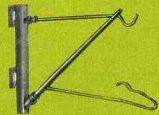

Märklin catenary system for K+M-tracks

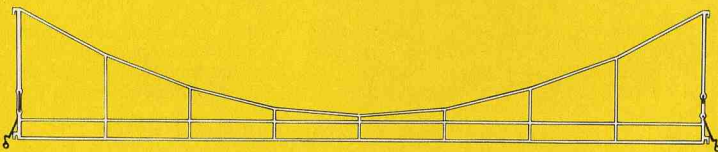

7016

Cross-span · For hooking into tower masts · Spans about 4 tracks · Span 390 mm (1 ft. 3³/₈"')

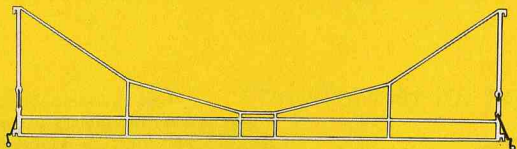
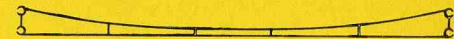

7017

Cross-span · For hooking into tower masts · Spans about 3 tracks · Span 280 mm (11")

7278

Contact wire section for use over the inner track curve on curved double track sections of the 2100 series · Length 235 mm (9¹/₄"')



7018

Contact wire section for straight and curved track sections · Length 270 mm (10⁵/₈"')

7019

Contact wire section for straight track sections only · Length 360 mm (1 ft. 2¹/₈"')



All contact wire sections are nickel-plated.

7022

Insulator section · Male portion (for push-fit connection) for interrupting the overhead line current · Length 115 mm (4¹/₂"')

Using contact wire sections 7014, 7015 and 7023 it is possible to make up any length from 177 to 360 mm (7"-14¹/₈"').

7023

Make-up section for push-fit connection · Length 100 mm (4")

The push-fit connections can be strengthened if necessary using the fastening kit 7004 (see illustration).

7277

Crossing section for 2158, 2159, 2160, 5114, 5128, 5207 and 5211

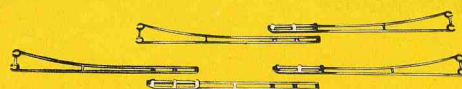

Usual colors of electrical leads in Märklin circuits:

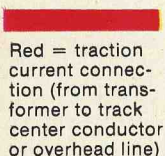

Red = traction current connection (from transformer to track center conductor or overhead line)



Yellow = lighting and solenoid-operated items

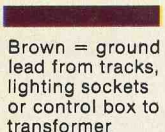

Brown = ground lead from tracks, lighting sockets or control box to transformer

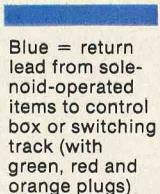

Blue = return lead from solenoid-operated items to control box or switching track (with green, red and orange plugs)

Electrical leads

The copper conductor in these stranded leads consists of 24 separate strands each of 0.10 mm (0.004") diameter, giving an overall cross-sectional area of 0.19 mm² (0.03 sq. "). That is more than enough even to cope with the current flowing through a short-circuited 40 VA transformer.

7100 Lead · Single core · Gray · 10 m (33 ft.)

7101 Lead · Single core · Blue · 10 m (33 ft.)

7102 Lead · Single core · Brown · 10 m (33 ft.)

7103 Lead · Single core · Yellow · 10 m (33 ft.)

7105 Lead · Single core · Red · 10 m (33 ft.)

Sleeves



7111 = brown
7112 = yellow
7113 = green
7114 = orange
7115 = red
7117 = gray

Plugs with side sockets



7131 = brown
7132 = yellow
7133 = green
7134 = orange
7135 = red
7137 = gray

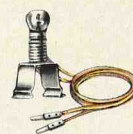

7073

Lamp socket with bulb and lead for stations, freight sheds, etc.
Light bulb = 60020



7000

Staples · Bag of 50 · For fixing leads to a wooden base



5004

Connector lead for center conductor · Length 750 mm (2 ft. 5 1/2")

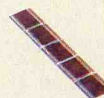

5022

Center conductor isolators for 5 isolation points

Accessories for remote operation

Circuit diagram of 7210 (with switch 3 closed)

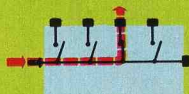

Circuit diagram of 7211 (with switch 3 closed)

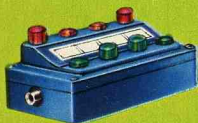
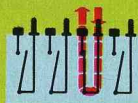

7072

Control box with 8 sockets for connecting 4 double-solenoid-operated articles · The position of signals, turn-outs etc. can be seen from the position of the push-buttons · Length 80 mm (3 1/8") · Width 40 mm (1 1/2")

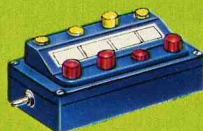

7210

Control box with indicator push buttons for distributing current to 4 traction current or lighting circuits · Length 80 mm (3 1/8") · Width 40 mm (1 1/2")

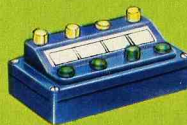

7211

Control box for switching 4 different traction or lighting circuits on and off by indicator push buttons · Length 80 mm (3 1/8") · Width 40 mm (1 1/2")



7209

Distribution strip · Width 11 single sockets · Size 50 x 20 mm (2" x 3/4")



7229

Distribution strip with 5 connector terminals, permanently connected together · Length 38 mm (1 1/2") · Width 10 mm (3/8")

6699 **new**

Power pack with electronic control for slow speed drive · For connection to Märklin lighting transformer 6611 or to the lighting sockets of a Märklin transformer with 30 VA output power · Lighting voltage 16 V · Electronic control of locomotive speed and direction of motion · Maximum permitted load 1.8 Amperes · Plastic case · Weight 315 grammes · Dimensions 125 x 135 x 55 mm (4 15/16" x 5 3/16" x 2 3/16") · Use Märklin leads and plugs to extend connector leads if required



Perfect for HO:

The motion of a real train can now be realistically simulated, i.e. gradual starting and braking and very slow speed drive.



Transformers for HO gauge and I gauge

Märklin heavy-duty transformers

Every Märklin transformer is completely safe, with insulation which has been tested to several thousand volts. Furthermore, a built-in cut-out switches off the current if a short circuit occurs somewhere on the track or if the transformer is overloaded. The transformer has a lead and a plug for connection to an a.c. mains socket or standard lamp.

Locomotive speed is proportional to the traction voltage, i.e. when the red control knob is turned to the right the locomotive goes faster, when to the left, slower. If the control knob is turned momentarily to the left of the zero position, a nominal 24 V pulse operates the reversing switch (the "driver") in the locomotive and changes the direction of motion.

We guarantee trouble-free operation of our railroads only when genuine Märklin transformer are used.

6671 220 Volt

Transformer · Output 16 VA · Traction voltage adjustable between approximately 4 V and 16 V · Lighting voltage 16 V · Plastic case · Weight 1.2 kg · Dimensions 125 × 135 × 75 mm (4⁹/₁₆" × 5⁵/₁₆" × 3")

For particular requirements we supply a transformer under the following number:

- 6660** 100 Volt Japan
- 6667** 110 Volt USA (60 Hz)
- 6669** 240 Volt England

We guarantee trouble-free operation of our railroads only when genuine Märklin transformer are used.



16 VA

Märklin 16 VA and 30 VA transformer have connections for traction current supply and for lighting or solenoid-operated items.

To be connected to alternating current (a.c.) mains supply only

Power consumption by locomotives and lights

Calculation examples:

This is how to calculate the number of items which can be connected to the transformer: the 3-axle tank locomotive 3000 takes about 9 VA, the express diesel locomotive 3021 and the heavy express steam locomotive 3085 each take about 12 VA. Any margin of power left over after accounting for the locomotives can be used for train or layout lighting, counting 1 VA for each bulb used.

The transformers in the gift packs, mentioned on pages 7-9, have the same good features as the transformers described here, the only difference being that their power output is less.

6631 220 Volt

Transformer · Output 30 VA · Traction voltage adjustable between about 4 V and 16 V · Lighting voltage 16 V · Plastic case · Red pilot lamp · Weight 2.1 kg · Dimensions 158 × 135 × 75 mm (6¹/₁₆" × 5⁵/₁₆" × 3")

Ⓛ = 60015

For particular requirements we supply transformers under the following numbers:

- 6620** 100 Volt Japan
- 6627** 110 Volt USA (60 Hz)
- 6629** 240 Volt England

When ordering, please quote the number corresponding to the appropriate mains voltage.

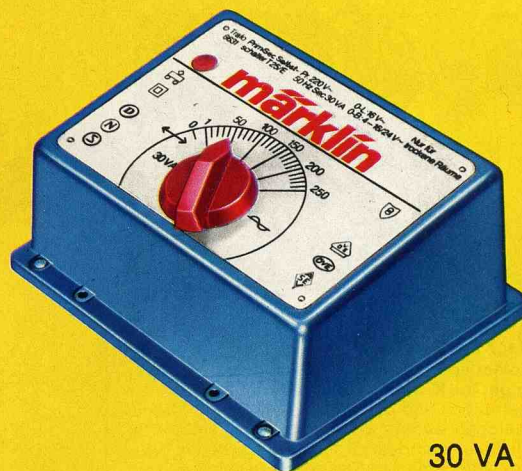

30 VA

Transformer for lighting

6611 220 Volt

Transformer for lighting and for solenoid-operated items · Output 40 VA · Output voltage approximately 16 V a.c. · Plastic case · Weight 2.0 kg · Dimensions 158 × 135 × 75 mm (6¹/₁₆" × 5⁵/₁₆" × 3")

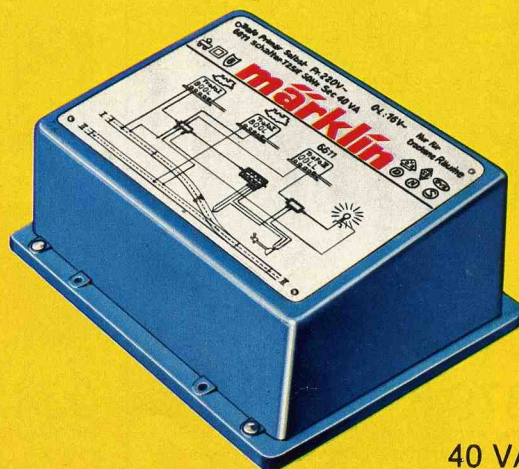

40 VA

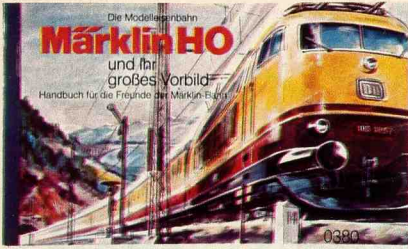

0380

Booklet entitled "Märklin HO railroads and their originals", a handbook for Märklin model railroaders. Contents include suggestions for designing and landscaping model railroad layouts, details of Märklin locomotives and cars and the originals on which they are modeled, signals, railroad regulations and procedures, examples of circuits, e.g. for simultaneous operation of several trains, and much more besides. Contents 228 pages. Size 15x24 cm (6" x 9 1/2"). German text

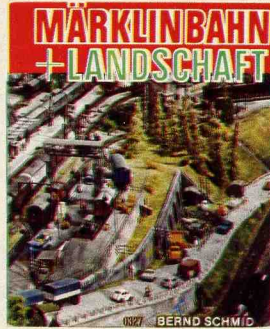

0327

Booklet entitled "Märklin railroads + landscapes", by Bernd Schmid. An invaluable guide to help you design your own railroad system. Every detail of the construction of an HO gauge system is covered. The book has many illustrations, including some in color. Technical details, track layout, landscape planning and the fitting out of a railroad system are treated in detail by a well-known model railroad expert. An invaluable source of information for any model railroader. Contents 192 pages. Size 16.4x20.3 cm (6 1/2" x 8"). German text

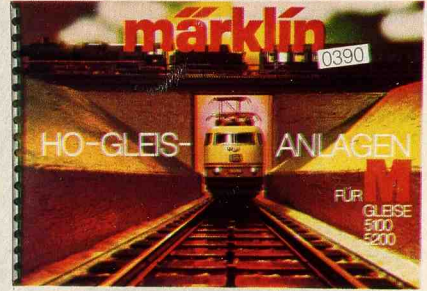

0392 M

Booklet entitled "Märklin track layouts, HO gauge, for M-tracks 5100 and 5200". With full color illustrations and detailed track plans for 16 fully developed layouts with catenary systems. The individual electrical circuits are marked in distinguishing colors. The accompanying text includes many examples of track and turnout combinations. An outstanding guide for the construction of layouts of any size. Contents 56 pages. Size 21x30 cm (8 1/4" x 1 ft.). English text

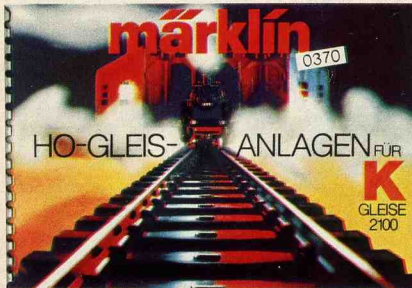

0372 K

Booklet entitled "Märklin track layouts, HO gauge, for K-tracks 2100". With full color illustrations and detailed track plans for 16 fully developed layouts with catenary systems. The individual electrical circuits are marked in distinguishing colors. The accompanying text includes many examples of track and layout combinations. An outstanding guide for the construction of layouts of any size. Contents 52 pages. Size 21x30 cm (8 1/4" x 1 ft.). English text

11 Anlage 225 x 150 cm

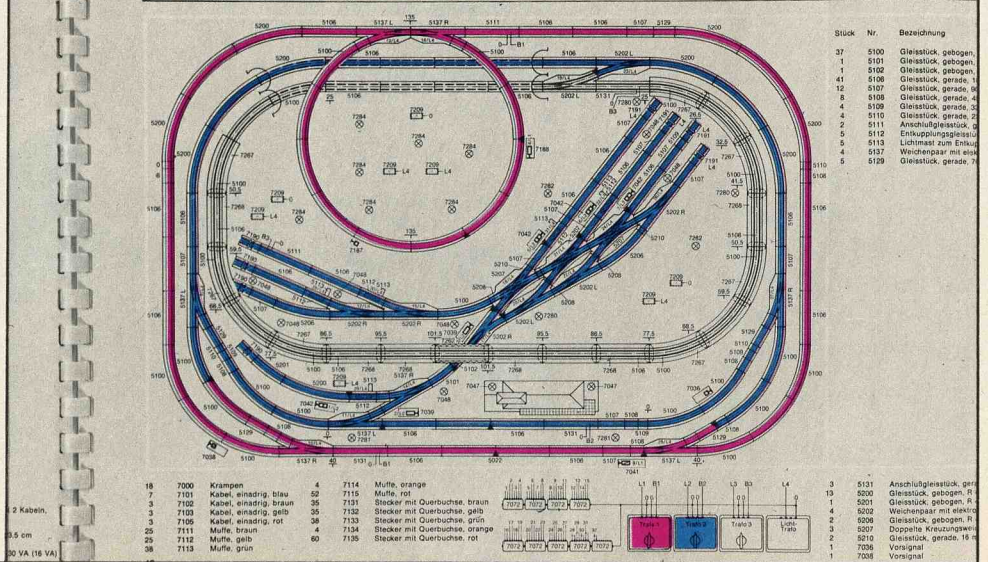

0379 K

Booklet entitled "Märklin track layouts, HO gauge, for K-tracks 2100". Contains 7 simple track plans. Contents 20 pages. Size 15x21 cm (6" x 8 1/4"). English text

Märklin booklets are available from your Märklin dealer

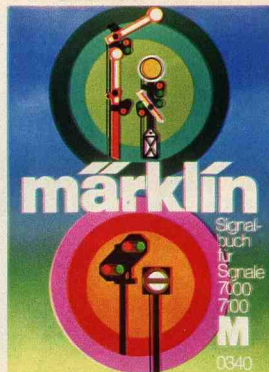

0342 M

Märklin signal manual for signals 7000 and 7100. A detailed explanation, with full color illustrations, of the installation and use of 7000 and 7100 series signals and the universal remote control switch with the M-track system. Contents 28 pages. Size 18x25 cm (7" x 10"). English text

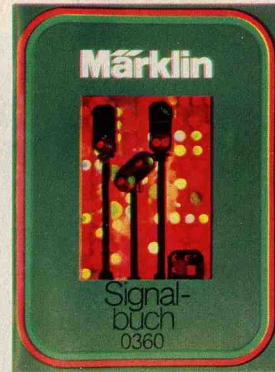

0361 K

Märklin signal manual for signals 7200. A detailed explanation with six-color illustrations of the installation and use of signals and remote control switches of the 7200 series. Contents 48 pages. Size 18x25 cm (7" x 10"). English text



The smallest electric railway in the world

Scale 1 : 220

mini-club, a unique hobby

Märklin mini-club was developed especially for adults. It incorporates the best technology, offers fascinating versatility and is wonderfully realistic.

Mini-club is easy to carry around, and it can be set up in lots of different ways. The range of items, already extensive, continues to grow. There is plenty of scope for individuality in planning and

operating a railroad. A comprehensive and yet compact layout can also be built-up by following the logical SET extension program.

Many accessories are available to add a realistic atmosphere to your railroading. Or you may have your own bright ideas: quite ordinary little objects like corks and matchboxes assume fascinating propor-

tions when used as landscaping in a mini-club operation.

It's not without reason that Märklin mini-club continues to grow in popularity. You ought to treat yourself (or a friend) to this unique, beautiful little railroad. Mini-club will continue to prosper. The Märklin traditions of attention to detail and insistence on high quality will see to that.

mini-club: concentrated precision engineering

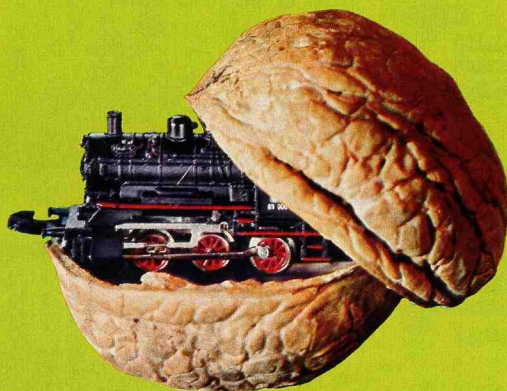

This locomotive is depicted in its actual size.

Our suggestion
for an ideal
start:

Märklin mini-club
SET 123 with
Toporama 8930

This layout consists of basic set S 8905-8909, extension sets E 8190 or E 8191, double track set T 1 8192, station track set T 2 8193, switching track set T 3 8194 = SET 123 and Toporama 8930. See also pages 74 and 75.

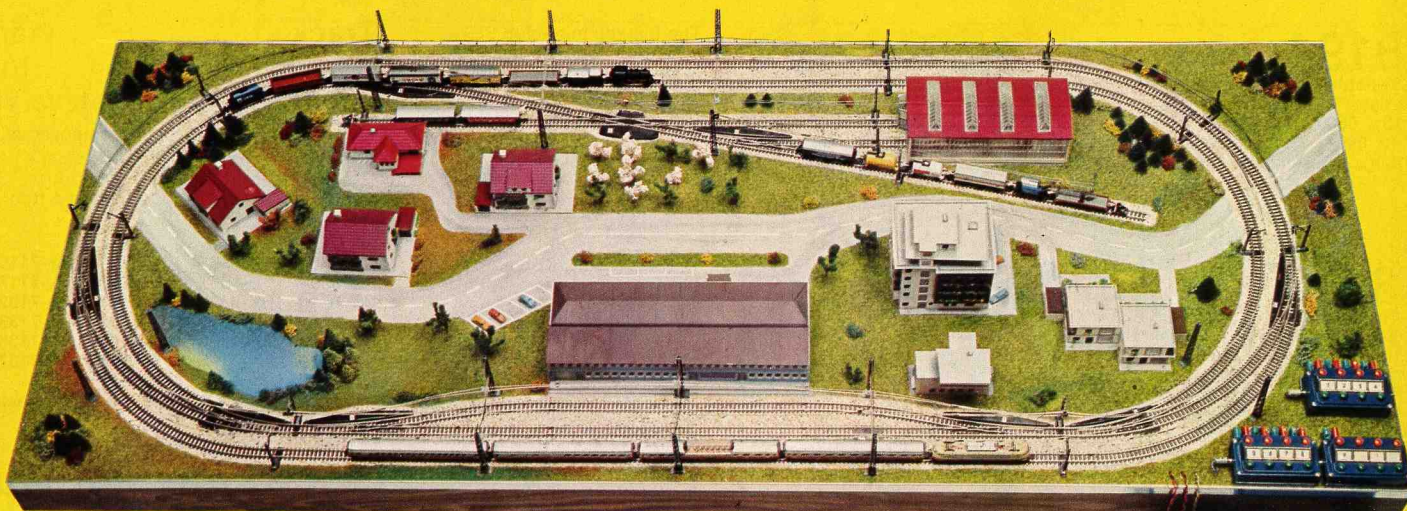

mini-club SET

8905-8909

Freight train with power pack S



8190

Extension set E · Comprises:
1× 8564 · 2× 8591 · 10× 8500 ·
Assembly instructions

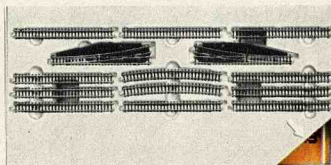

The starting point is a **basic set S** with a freight train, oval track and power pack S 8905-8909 (see page 76).

8191

Extension set E · Comprises:
1× 8561 · 2× 8591 · 10× 8500 ·
1× 7072 · 1× 7209 · Leads,
sleeves and plugs · Assembly in-
structions

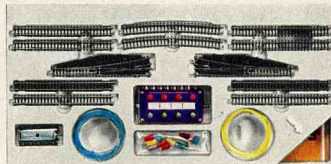

The first extension stage is an **extension set E 8190** or **extension set E 8191**.

8192

Double track set T1 · Comprises:
1× 8567 · 2× 8521 · 4× 8530 ·
6× 8500 · 1× 7072 · 1× 7209 ·
Leads, sleeves and plugs ·
Assembly instructions

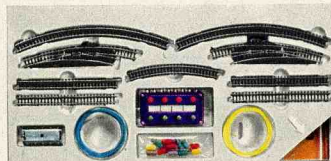

From here on, there are three more extension sets for building up to the ideal mini-club layout:

double track set T 1 8192
station track set T 2 8193
switching track set T 3 8194

8193

Station track set T2 · Comprises:
1× 8567 · 2× 8521 · 2× 8504 ·
6× 8500 · 1× 7072 · 1× 7209 ·
Leads, sleeves and plugs ·
Assembly instructions

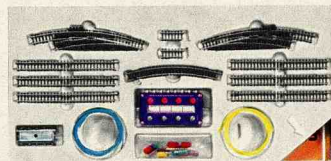

The three track sets T1, T2 and T3 can be added in any order. Depending on how you prefer to operate your railroad, you can use one of the four schemes shown on page 75 or think up a variation of your own.

8194

Switching track set T3 · Com-
prises: 1× 8560 · 1× 8561 ·
10× 8500 · 1× 7072 · 1× 7209 ·
4× 8991 · Leads, sleeves and
plugs · Assembly instructions

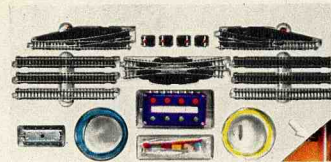

The Märklin mini-club SET extension program culminates in the addition of the **mini-club catenary system**.

8930

Toporama for the mini-club SET extension program · Model railroad landscape · Multicolor printing · The track layout up to stage T3 (8194) is printed on · Can be used from stage E (8190, 8191) onward · Size 50×120 cm (1ft. 8"×4ft.)

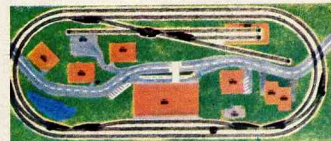

And how is the Toporama used?

Quite simple: the Toporama mat is laid, or glued, or fastened onto a base plate, the track is laid in accordance with the full scale printed layout, the connections are made and you are ready to roll. No other landscaping is needed, as the Toporama includes fields, streams, lakes, roads and parking lots.

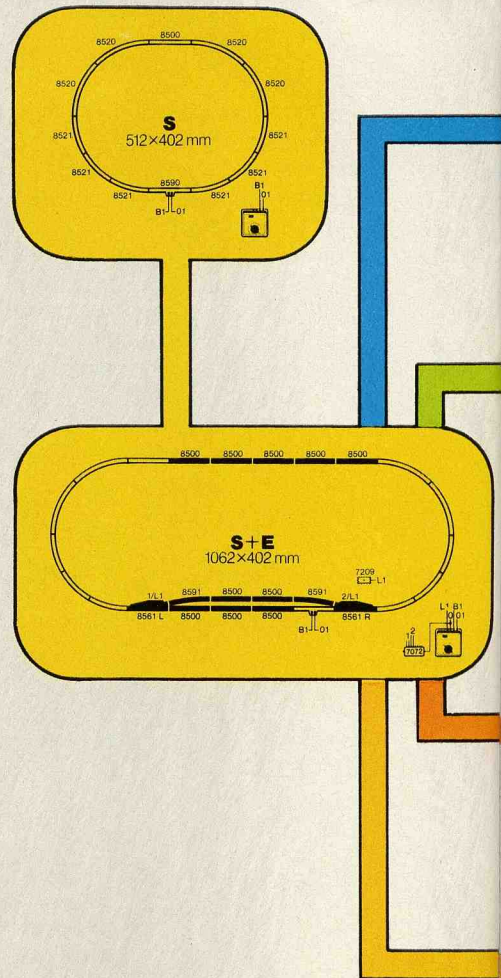

Track current supply system

Mini-club layout SET 123 is composed of the following individual items:

33-8500	2-8561	4-7072	9-7115
2-8504	2-8567	4-7209	4-7117
4-8520	1-8590	1-7101	4-7132
10-8521	2-8591	1-7103	9-7133
4-8530	4-8991	4-7112	9-7135
1-8560		9-7113	4-7137

1 mini-club power pack

Size of layout
120×50 cm

SET, the way to build up to a mini-club layout

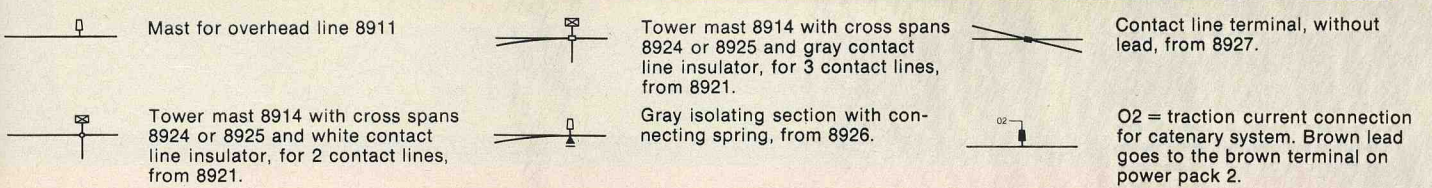
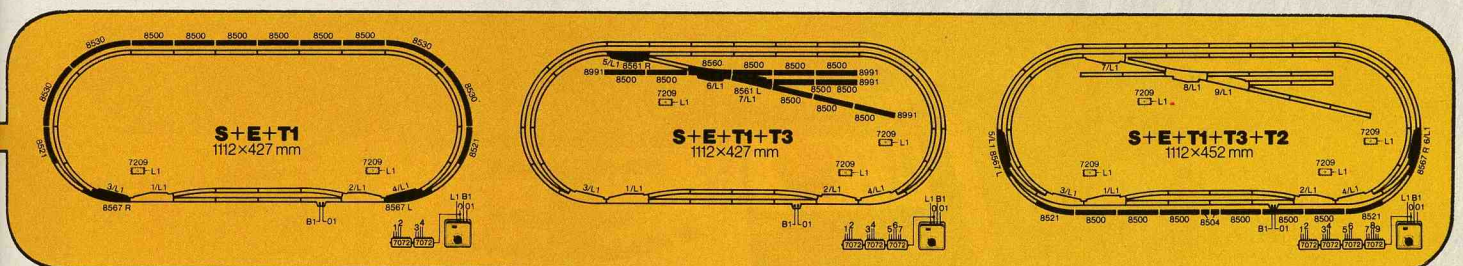
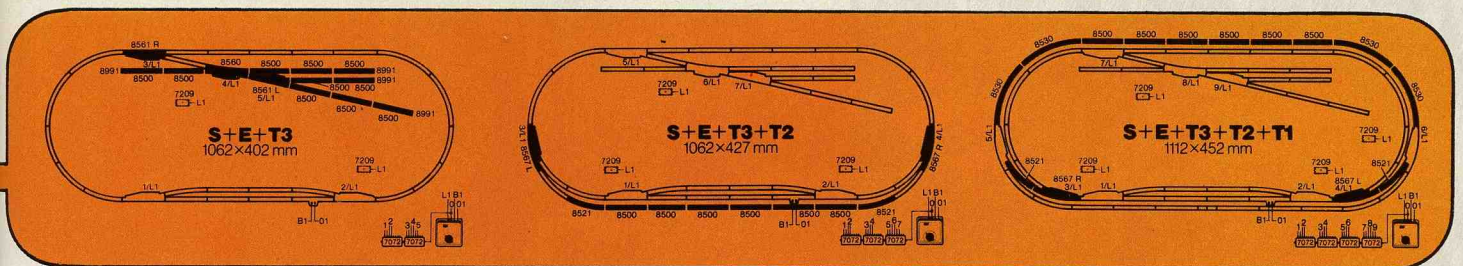
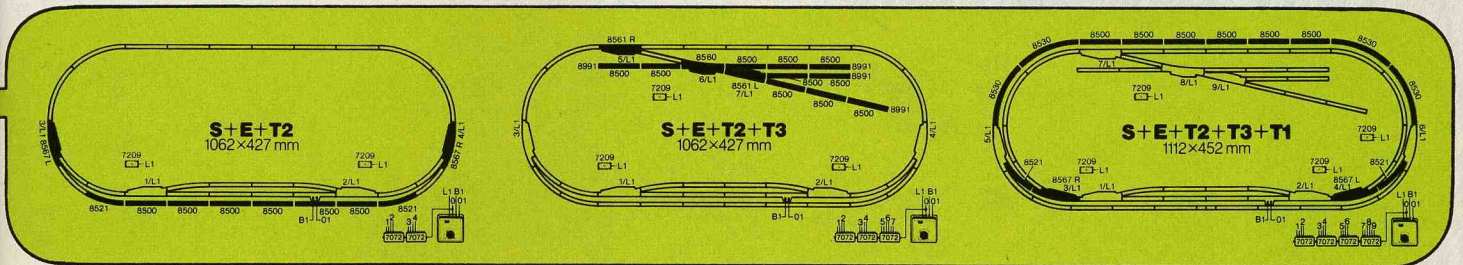
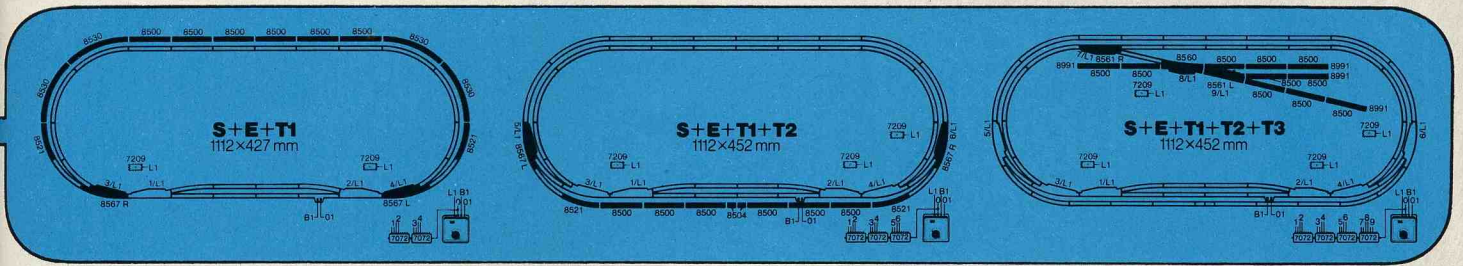

Catenary current supply system

The following items are required to enable the whole SET layout to be powered from a catenary system:

- 22-8911
- 1-8912
- 16-8914
- 3-8921
- 15-8922
- 35-8923
- 2-8924
- 6-8925
- 1-8926
- 1-8927

1 mini-club power pack

(4 ft. x 1 ft. 8")

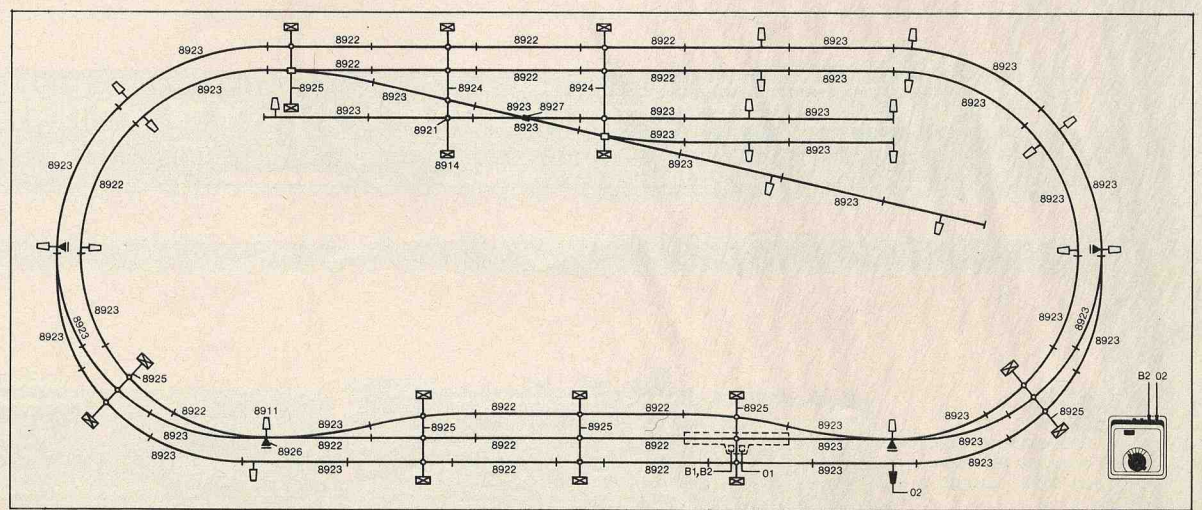

All you want to know at a glance:

Märklin mini-club has the gauge designation Z (6.5 mm) (1/4"). Märklin mini-club is powered by direct current. Everything carrying the name mini-club is of proven Märklin quality and is as strong, durable and effective as all the other Märklin railroads.

The locomotives are fitted with radio interference suppressors. In conjunction with the suppressors fitted in the Märklin power packs 6711 and 6720–6731 and in the feeder track section 8590, these ensure a high standard of suppression.

Mini-club locomotives must only be provided with power from Märklin power packs 6711 or 6720–6731 (with a maximum traction voltage of 8 V) or the power pack included in a train set.

- 8905 S 100 Volt Japan
- 8907 S 110 Volt USA (60 Hz)
- 8908 S 240 Volt Australia
- 8909 S 220 Volt



Freight train with power pack · With tank locomotive 8800, banana car 8606, low sided car 8610, 1 straight track section 8500, 4 curved track sections 8520, 6 curved track sections 8521, feeder track section 8590 and power pack · Length of train 160 mm (6 3/16")

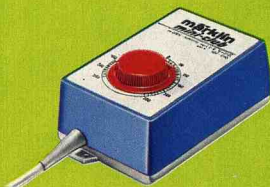

The power pack included with this set is not available separately.

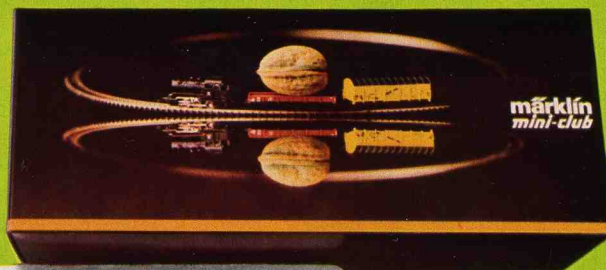

A reply card is included with every basic set. Anyone sending this card in to Märklin will become a member of the mini-club owners' circle. Members of this group receive information on mini-club developments, can take part in competitions and can communicate directly with our mini-club consultant on particular railroad problems.



8100 **new**

Express train · With express locomotive 8891, 2 express coaches 8731 and 1 express baggage car 8732 · Length of train 372 mm (1 ft. 2 5/8")



Train sets

This will delight every man

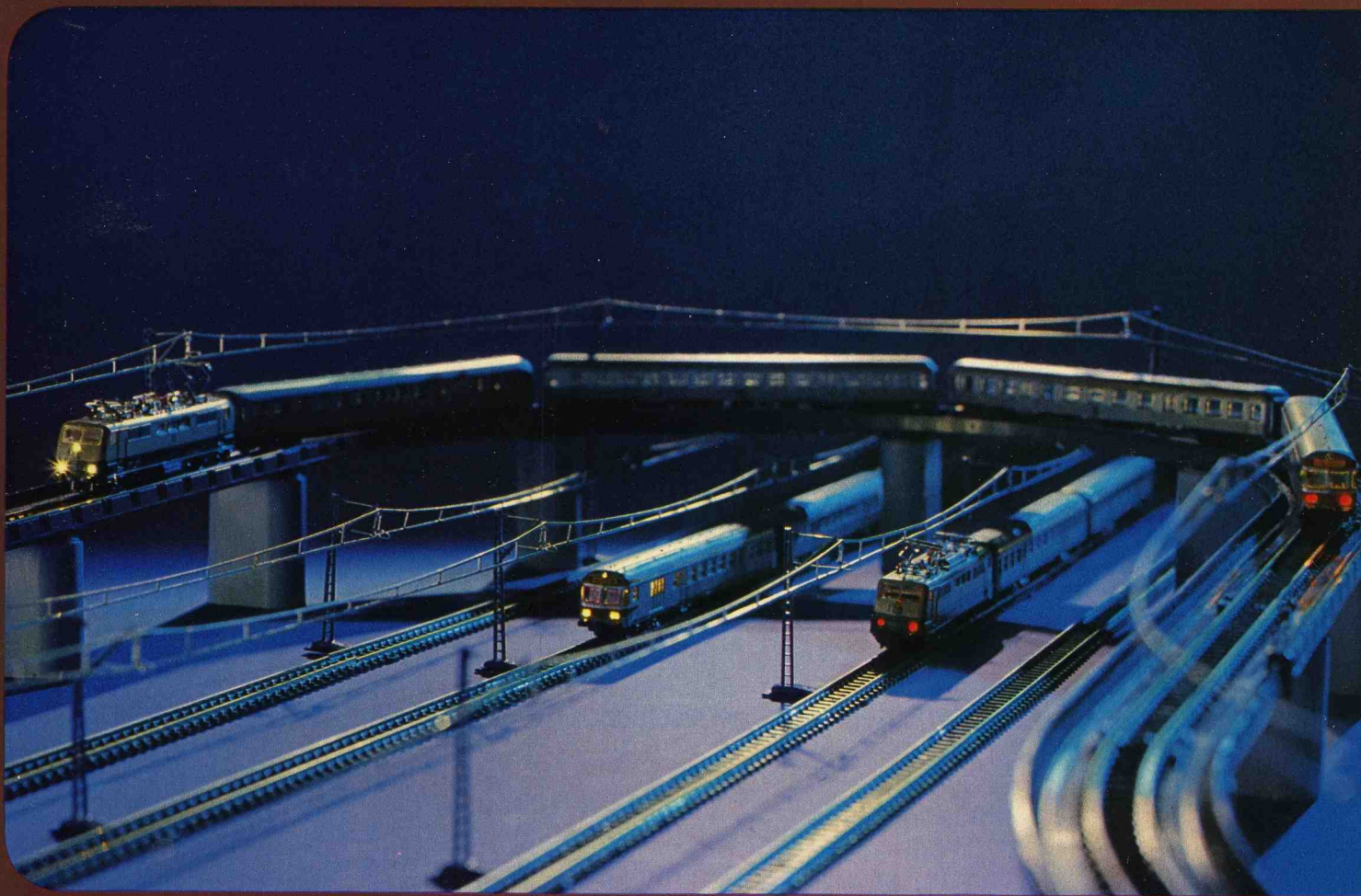

8101 **new**

Multiple unit train · With electric locomotive (E 111), 1 local passenger service coach 8716, 1 local passenger service coach 8717 and 1 local passenger service coach with baggage compartment and control room 8718 · The locomotive and the control car are fitted with a lighting system which changes over automatically when the train changes direction, so that the train always displays 3 white headlights in front and two red taillights at the rear · Length of train 449 mm (1 ft. 5³/₄"')

Only the locomotive of this train set is fitted with the automatic red and white light changeover system. This locomotive is not available separately.

Multiple unit trains, which are usually used on local passenger services, consist of a locomotive, a number of intermediate cars depending on the traffic density, and the control car at the rear. At the end of the line all the driver has to do is to change driving positions, from the locomotive to the control car, for example, and drive back with the locomotive now pushing instead of pulling.

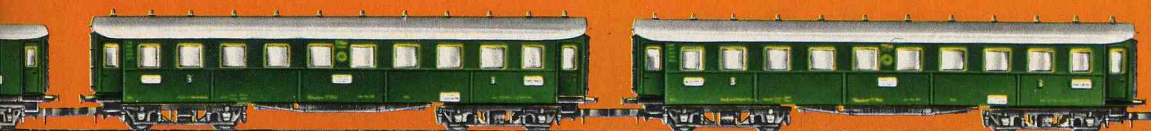

Features of steam locomotives

Remote control for forward and reverse drive · Three working headlights (8953, 8800 without lights, 8803 capable of taking lighting set

8953) · 3 driven axles · Automatic coupling at rear end of locomotive or on the tender · Die cast zinc frame · Mat black metal body

Mini-club locomotives must only be powered by a Märklin power pack, items 6711 or 6720-6731 (with a maximum traction voltage of 8 V) or by the power pack included in the train set.

8800

Tank locomotive · A model of the BR 89 locomotive · Wheel arrangement 0-6-0 · Automatic coupling at each end · Length over buffers 45 mm ($1\frac{3}{4}''$)



8895

Tank locomotive · A model of the German Federal Railways BR 74 locomotive · Wheel arrangement 2-6-0 · Length over buffers 55 mm ($2\frac{3}{16}''$)

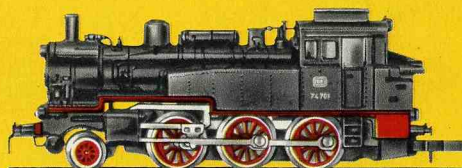

8803

Passenger train locomotive with tender · A model of the German Federal Railways BR 24 locomotive · Wheel arrangement 2-6-0 · Length over buffers 82 mm ($3\frac{1}{4}''$)



8891 **new**

Express locomotive with tender · A model of the former German State Railways BR 18⁴ · Wheel arrangement 4-6-2 · Length over buffers 106 mm ($4\frac{3}{16}''$)



8893 **new**

Express locomotive with tender · A model of the German Federal Railways BR 18⁴ · Wheel arrangement 4-6-2 · Length over buffers 106 mm ($4\frac{3}{16}''$)



8827

Freight train locomotive with tender · A model of the German Federal Railways BR 41 · Wheel arrangement 2-8-2 · 4 driven axles · Length over buffers 112 mm ($4\frac{3}{8}''$)

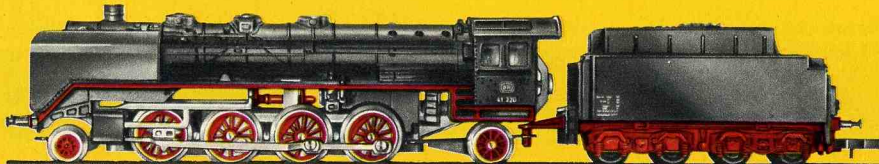

Power in miniature

8885

Express locomotive with tender
 A model of the German Federal Railways BR 003
 Wheel arrangement 4-6-2
 Length over buffers 112 mm (4³/₈"')

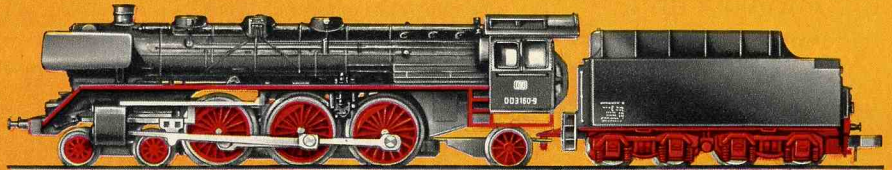

The well-known "Guinness Book of Records" gives the world duration record for model railways as 440.7 km (273.8 miles). Our mini-club locomotive 8885 covered 720 km (447 miles). It required 1219 hours to cover this distance, and no repairs or maintenance were needed. The duration test was carried out by an impartial testing organisation.

Test layout comprised of ordinary series-produced mini-club items: oval track with lap distance of 276 cm (10 ft. 7"). Locomotive 8885 with 6 express coaches and mini-club power pack.



Features of electric locomotives

Remote control for forward and reverse drive
 Both trucks driven
 Three working headlights at each end, changing over with change of direction (☺ = 8953)
 Changeover switch for selecting catenary or track supply

2 springloaded pantographs on roof
 Automatic coupling at each end
 Die cast zinc frame
 Body in realistic color scheme
 Windows inset in plastic frames

8842

Electric express locomotive
 A model of the German Federal Railways' BR 111
 Wheel arrangement B-B
 Length over buffers 76.8 mm (3")

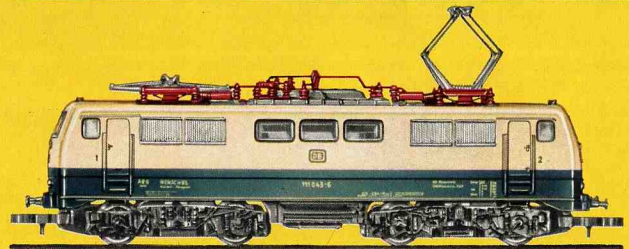

8854

Electric express locomotive
 A model of the German Federal Railways' BR 103
 Wheel arrangement C-C
 Length over buffers 88 mm (3¹/₂"')

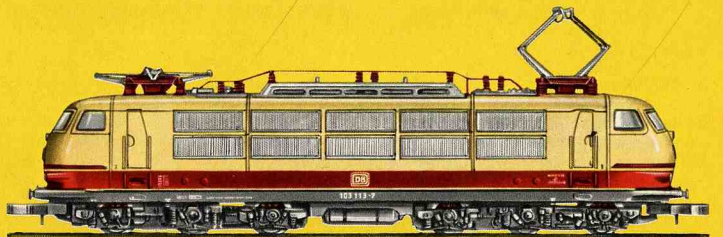

8857

Electric freight train locomotive
 A model of the German Federal Railways' BR 151
 Wheel arrangement C-C
 Length over buffers 88 mm (3¹/₂"')

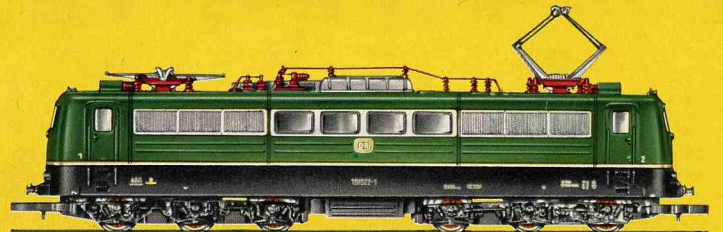

8858

Electric freight train locomotive
 A model of the German Federal Railways' BR 151
 Wheel arrangement C-C
 Length over buffers 88 mm (3¹/₂"')



Features of diesel locomotives and railcars

Remote control for forward and reverse drive · All axles driven · Three working headlights at each end
(Ⓞ = 8953, except for 8802 and

8864) · Automatic coupling at each end · Die cast zinc frame · Body in realistic color scheme

8816

Railbus · A model of the German Federal Railways' type 798 · Length over buffers 62 mm (2⁷/₁₆"')

8817

Trailer for railbus · A model of the German Federal Railways' type 998 · Length over buffers 62 mm (2⁷/₁₆"')

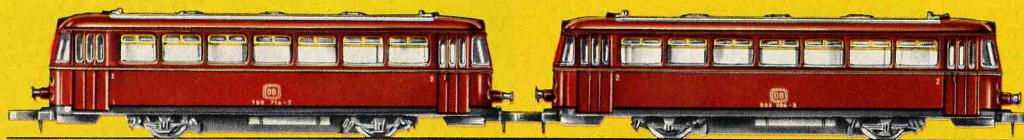

8864

Diesel locomotive · A model of the German Federal Railways' BR 260 · Wheel arrangement 0-6-0 · Colored metal body · Length over buffers 49 mm (1¹⁵/₁₆"')



8874

Diesel locomotive · A model of the German Federal Railways' BR 216 · Wheel arrangement B-B · Three working headlights at each end, changing over with change of direction · Length over buffers 75 mm (3")



8875

Diesel locomotive · A model of the German Federal Railways' BR 216 · Wheel arrangement B-B · Three working headlights, changing over with change of direction · Length over buffers 75 mm (3")



8802 **new**

Track-cleaning railcar · 2 driven axles · Automatic couplings · Length over buffers 62 mm (2⁷/₁₆"')



Schematic drawing showing the method of operation of the track-cleaning railcar

This vehicle has two driven axles. The rear wheels are ridged to provide extra friction. Two track-cleaning ridged wheels are located ahead of the front axle. These wheels rotate faster than the driving wheels. This causes the dirt on the track to be swept off.

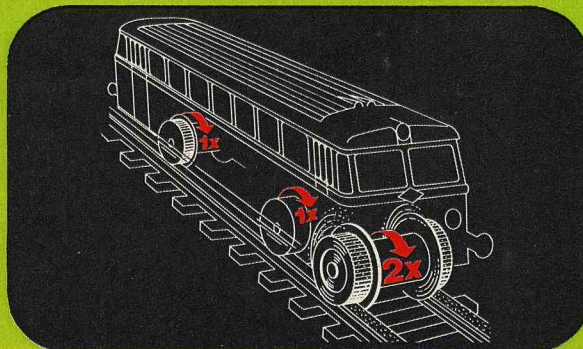

Express coaches

Models of German Federal Railways coaches · Windows inset in plastic frames · Length 120 mm (4³/₄"')

8710

Express coach · Aüm · 1st class



8711

Express coach · Büm · 2nd class



8712

Express baggage car · Düm



8713

Express dining car · WRüm

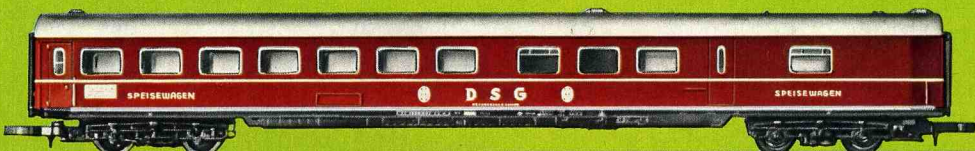

8720

Express coach · Aüm · 1st class



8721

Express coach · Büm · 2nd class



8722

Express baggage car · Düm



8723

Express dining car · WRüm



8714

Automobile rack car · DDm 915 · With 8 miniature automobiles aboard

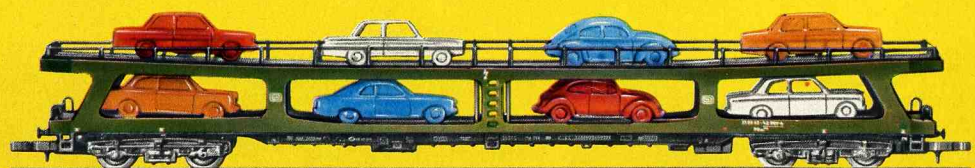

Express coaches Local passenger service coaches The illustrations are actual size

Models of German Federal Railways with peacock's eye pattern · Windows inset in plastic frames · Car bodies stainless steel-colored

8716

Local passenger service coach · Bnb · 2nd class



8717

Local passenger service coach · ABnb · 1st and 2nd class



8718 **new**

Local passenger service coach · BDnrzf · 2nd class · With baggage compartment and control car · Three working headlights and two red taillights, operating in accordance with the direction of motion



When the locomotive is pulling, 2 red taillights show on the control car.

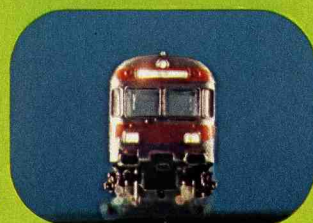

When the locomotive is pushing, 3 white headlights show on the control car.

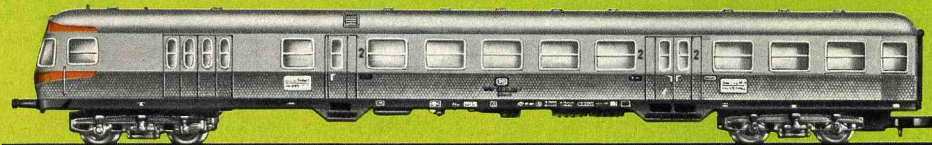

Models of cars of the former German State Railways · Windows inset in plastic frames

8731 **new**

Express coach · C4ü bay 11 · 3rd class · Length 87 mm (3⁷/₁₆"')

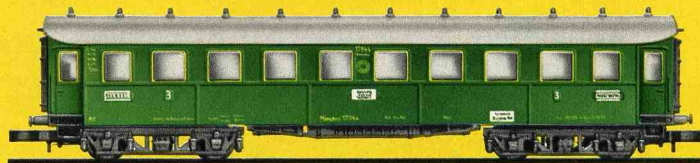

8732 **new**

Express baggage car · Pw4ü bay 09 · Length 78 mm (3¹/₁₆"')



TEE coaches

Branch line passenger coaches

German Federal Railways TEE coaches · 1st class ·
Windows inset in plastic frames · Length 120 mm (4³/₄"')

8724

TEE compartment coach · Avm



8725

TEE open-interior coach · Apm



8726

TEE dining car · WRm

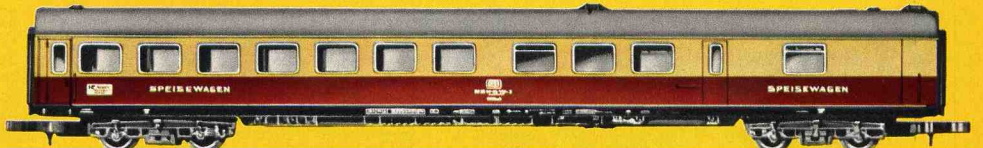

8728

TEE dome car · ADm ·
Transparent observation dome

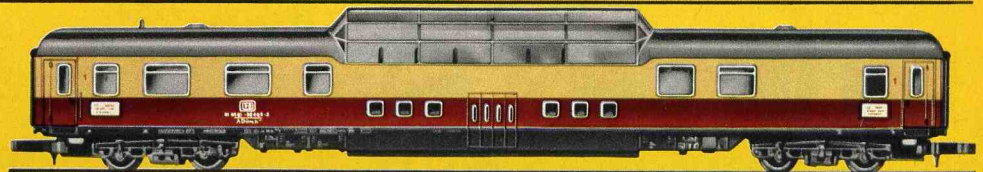

8734

TEE compartment coach · Avm ·
With interior lighting

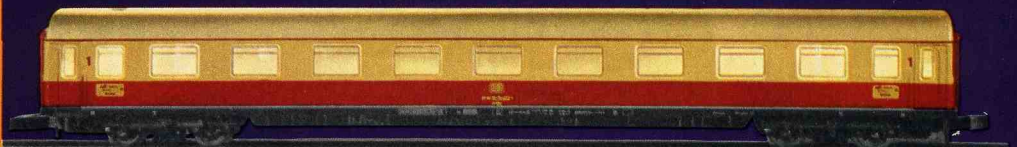

8735

TEE open-interior coach · Apm ·
With interior lighting



8736

TEE dining car · WRm ·
With interior lighting

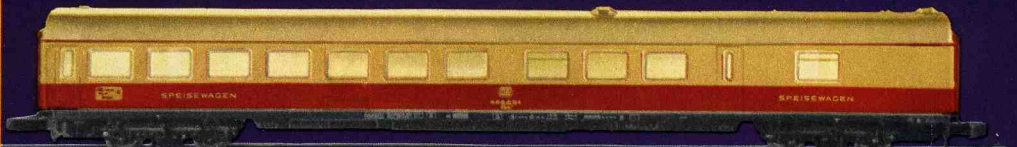

8738

TEE dome car · ADm · Transparent
observation dome · With interior lighting

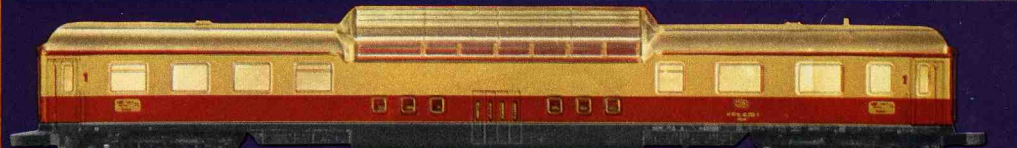

Platform and entrance at each end ·
Windows with "Cellon" panes ·
Length 60 mm (2³/₈"')

8700

Branch line
passenger coach



8701

Branch line
passenger coach



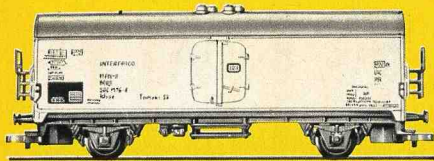

8600

Refrigerator car · A model of the German Federal Railways type Ichqrs · Length 54 mm (2¹/₈"')

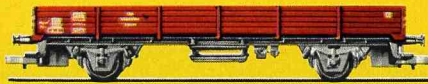

8610

Low-sided car · Length 54 mm (2¹/₈"')

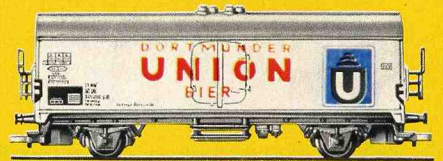

8601

Beer car · A model of a car owned by the Dortmunder Union Brewery · Length 54 mm (2¹/₈"')

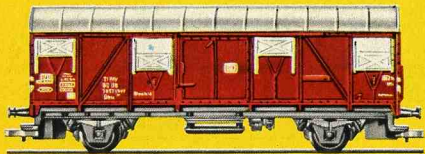

8605

Box car · A model of the German Federal Railways' type Gbrs · Length 54 mm (2¹/₈"')

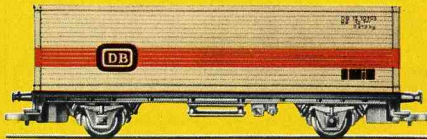

8615

Container car · German Federal Railways · Length 54 mm (2¹/₈"')

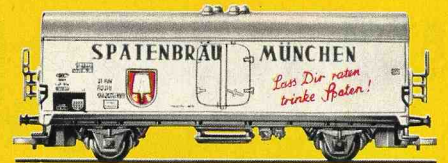

8602

Beer car · A model of a car owned by the "Spatenbräu" Brewery, Munich · Length 54 mm (2¹/₈"')

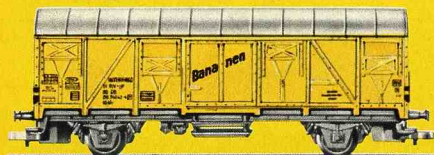

8606

Box car · A model of the German Federal Railways' type lbbls · Length 54 mm (2¹/₈"')



8616

Container car · SEALAND · Length 54 mm (2¹/₈"')



8603

Beer car · A model of a car owned by the Kulmbacher Mönchshof Brewery · Length 54 mm (2¹/₈"')

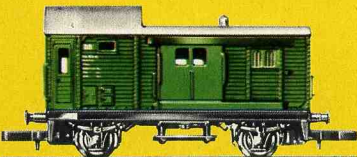

8609

Freight train baggage car (German Federal Railways' type Dg) · Doors on both sides which open · Length 40 mm (1⁹/₁₆"')



8622

Open freight car · A model of the German Federal Railways' type Omm 52 · Length 54 mm (2¹/₈"')



8604

Beer car · A model of a car owned by the Kulmbacher Reichelbräu Brewery · Length 54 mm (2¹/₈"')



8611

Tank car · Shell · Length 40 mm (1⁹/₁₆"')



8612

Tank car · Esso · Length 40 mm (1⁹/₁₆"')



8613

Tank car · Aral · Length 40 mm (1⁹/₁₆"')



8614 new

Tank car · BP · Length 40 mm (1⁹/₁₆"')



8625

Tank car · Shell · Length 75 mm (3"')



8626

Tank car · Esso · Length 75 mm (3"')

The model railroad system adults cannot resist

8619

Lumber car, in two parts ·
Loaded with sawn lumber ·
Length 93 mm (3⁵/₁₆")

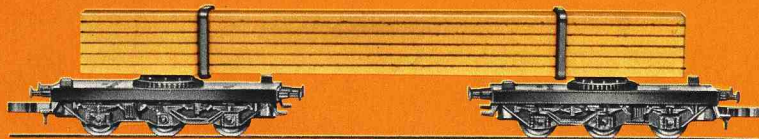

8620

Well car ·
Loaded with transformer ·
Length 154 mm (6¹/₁₆")

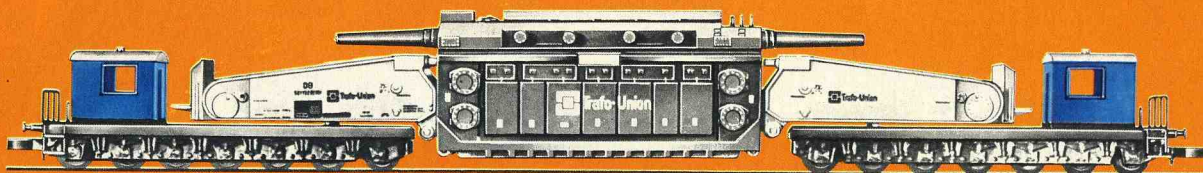

8621

Crane car with revolving crane, movable boom and boom support · Crane hook can be raised and lowered by hand crank · Length of underframe 35 mm (1³/₁₆") · (Low sided car 8610 is not included in the price but is recommended for use when moving the crane car)

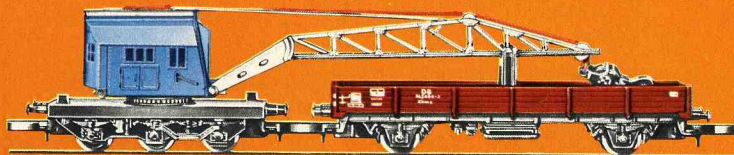



8963

Apartment block building kit with roof penthouse · The two top sections can also be used separately as a bungalow and a kiosk · Base area 86 × 84 mm (3³/₁₆" × 3³/₁₆") · Height 97 mm (3¹³/₁₆") · Can be fitted with light socket 8950



8968

Terrace house building kit, with garage · White · Can be built one or two-storied in a number of different ways, or can be used as a terrace house · Base area 81 × 45 mm (3¹/₁₆" × 1³/₄") · Height 29 mm (1¹/₂") · Can be fitted with light socket 8950

8969

Terrace house building kit, with garage · The same kit as 8968, but with pale blue wall sections



8964

Dwelling house building kit, with garage · Can be used one or two-storied · Base area 91 × 71 mm (3⁹/₁₆" × 2³/₁₆") · Height 45 mm (1³/₄") · Can be fitted with lighting socket 8950

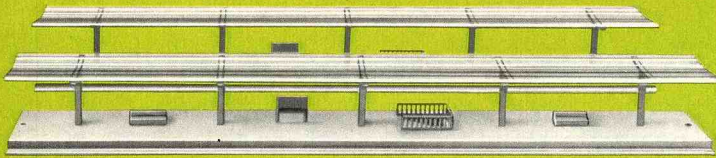

8961

Platform building kit · In 2 sections · Total length 440 mm (1 ft. 5⁵/₁₆") · Width 38 mm (1¹/₂") · Height 23 mm (7/₈")



8962

Dürnau station building kit · Multipurpose building with annex and loading ramp · Base area 70 × 50 mm (2³/₄" × 2") · Height 30 mm (1³/₁₆") · Can be fitted with lighting socket 8950

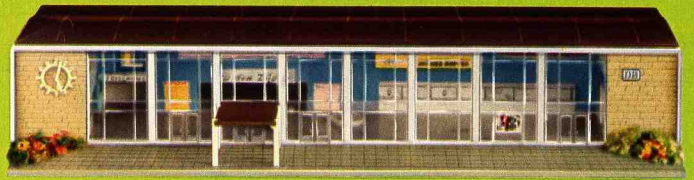

8960

Göppingen station (center block) building kit · Modern design · Base area 228 × 114 mm (9" × 4¹/₂") · Height 44 mm (1³/₄") · Can be fitted with lighting socket 8950



8965

Signal box building kit · Base area 69 × 39 mm (2³/₄" × 1⁹/₁₆") · Height 46 mm (1¹³/₁₆") · Can be fitted with lighting socket 8950



8970

Wintersdorf station building kit with main building, annex and covered passage-way · Can be used on its own or in conjunction with 8971 · Base area 72 × 112 mm (2³/₁₆" × 4¹/₂") · Height 54 mm (2¹/₈") · Can be fitted with lighting socket 8950

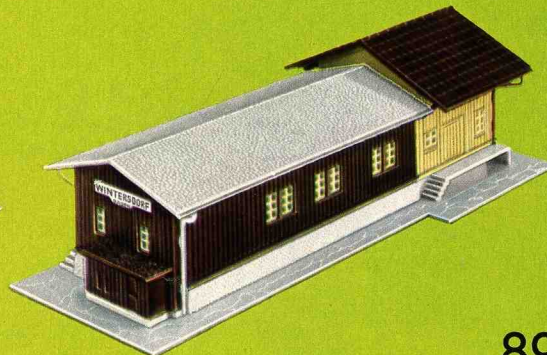

8971

Freight shed building kit with freight storage area, loading ramps and equipment storage room · Can be used on its own or in conjunction with 8970 · Base area 53 × 130 mm (2¹/₈" × 5¹/₈") · Height 38 mm (1¹/₂") · Can be fitted with lighting socket 8950

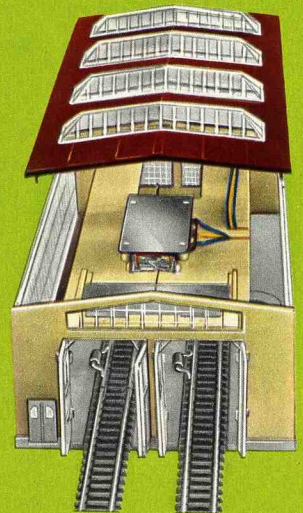

8980

Building kit for locomotive shed with solenoid-operated door operating mechanism · Arranged to take 2 locomotive parking tracks and overhead power lines · Length 152 mm (6") · Width 74 mm (2⁷/₈") · Height 51 mm (2") · The building kit includes 2 barrier track sections which will stop locomotives automatically as they enter the shed

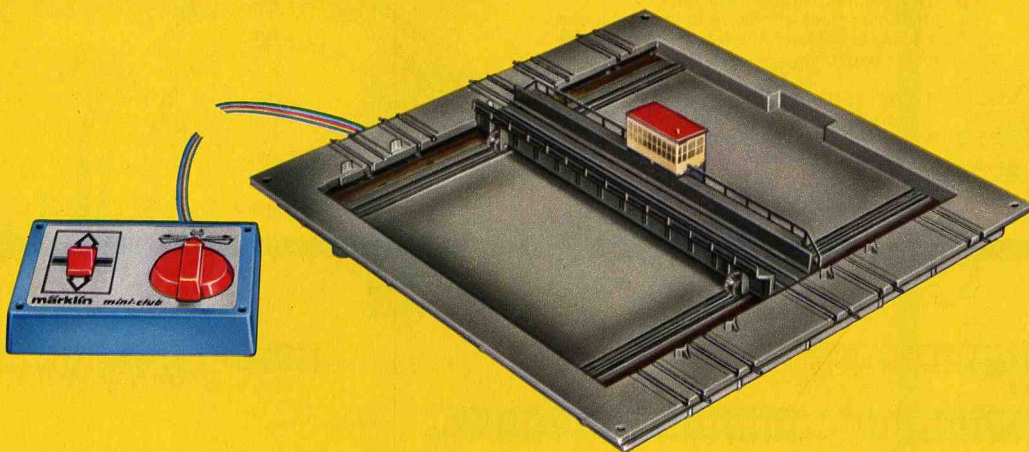

8994

Transfer table with 2 approach tracks and 4 × 2 parking tracks · Matches locomotive shed 8980 · For flush mounting in the layout base plate · Power pack for remote control of the transfer table and locomotives · Electric motor drive · Power is automatically disconnected from all tracks not in contact with the transfer table · Width and length both 220 mm (8⁵/₁₆"')

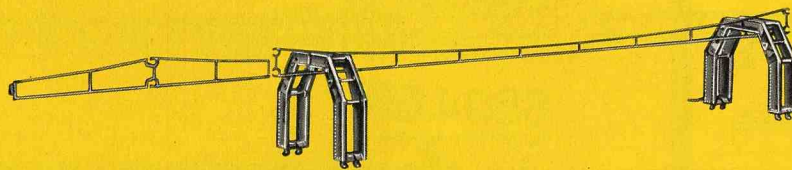

8995

Catenary system kit for transfer table · Consists of two catenary system support gantries, 1 contact wire section 8922 with lead soldered on, and 10 short contact wire sections

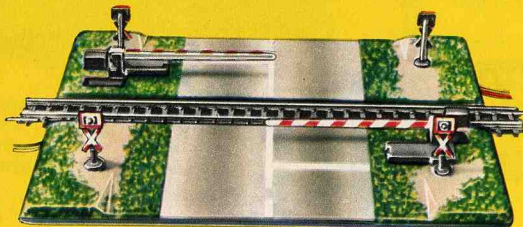
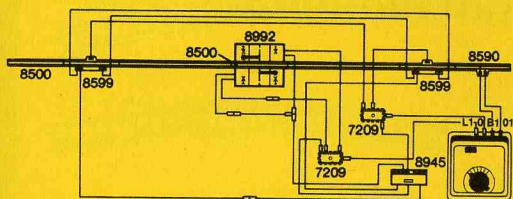

8992

Grade crossing with half barriers · Comprising 2 solenoid-operated barriers · 2 red warning lamps on each side, which light when the barrier is closed · Size of base 96 × 37 mm (3³/₄"' × 1⁷/₁₆"') · (The track sections shown in the illustration are not supplied with the grade crossing and are not included in the price)

⊙ = 8953

The following items are also required with the grade crossing:

a) for **manual operation**
1 manual signal control panel 8946

b) for **automatic operation** by a moving train

1 universal remote control switch 8945
2 switching track sections (of appropriate type, e.g. 8599, 8529 or 8539)

The various ways in which the grade crossing can be installed are fully described in the accompanying instructions for use.

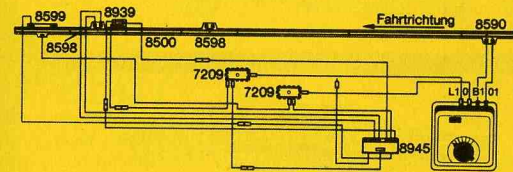

Circuit diagram showing connection of signal 8939 and connection of switching track section, on "stop" (Hp0).



8939

Color-light home signal · Signal lights change from red (Hp0) to green (Hp1) · 2 bulbs · Can be operated by the universal remote control switch 8945 or by the manual signal control panel 8946 · Height 34.5 mm (1³/₈"')

⊙ = 8953



8975

Arch bridge · Made of plastic · Gray · Length 220 mm (8⁵/₁₆"')



8976

Straight ramp section · Length 110 mm (4³/₈"')



8977

Curved ramp section · Radius 145 mm (5³/₄"') · Track curvature 45°



8978

Set of approach ramp columns · Contains one column of each of following heights: 4 mm, 8 mm, 12 mm, 16 mm, 20 mm, 24 mm, 28 mm, 32 mm, 36 mm and 40 mm (0.157" to 1⁵/₈"') · installation instructions are included

8979

Set of bridge piers · Comprising 5 piers 40 mm (1³/₈"') high



With a gauge of 6.5 mm ($\frac{17}{64}$ "), the overall width of Märklin mini-club track sections is about 11.5 mm ($\frac{7}{16}$ "). The height is about 2.5 mm ($\frac{1}{16}$ "). The accurately dimensioned nickel silver rails are mounted on plastic cross-ties. The track sections are joined to each other by means of rail joint clips, as on larger scale railroads. The rigidity of the track joints is increased by means of an additional claw coupling on the cross-ties.

This diagram shows the 3 Märklin mini-club track circles, with their radii, the distances between them and the curvature of the sections.

- 1 circle 8510 = 8 track sections
- 1 circle 8520 = 8 track sections
- 1 circle 8530 = 8 track sections

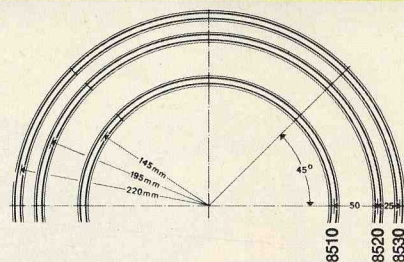

Straight track sections

8500

Length 110 mm ($4\frac{3}{8}$ ")



8504

Length 25 mm (1")

8505

Length 220 mm ($8\frac{5}{8}$ ")



8506

Length 108.6 mm ($4\frac{5}{16}$ ")
(see Fig. 2, page 89)



8507

Length 112.8 mm ($4\frac{1}{2}$ ")
(see Fig. 4, page 89)

8594 new

Length 660 mm (2 ft. 2")



Curved track sections

8510

Radius 145 mm ($5\frac{3}{4}$ ") · 45°



8530

Radius 220 mm ($8\frac{5}{8}$ ") · 45°



8520

Radius 195 mm ($7\frac{3}{4}$ ") · 45°



8531

Radius 220 mm ($8\frac{5}{8}$ ") · 30°



8521

Radius 195 mm ($7\frac{3}{4}$ ") · 30°



8591

Radius 490 mm (1 ft. $7\frac{5}{16}$ ") · 13° ·
Matches the curve of turnouts 8561
and 8564 (see Fig. 3, page 89)

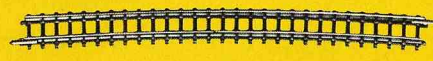

Tracks with special uses



8592

Straight track section · For adjusting to required length · Can be extended from 100 mm (4 ") to 120 mm ($4\frac{3}{4}$ ")



8590

Straight feeder track section · With capacitor for radio interference suppression · 2 terminals for connection of the traction current leads supplied · Length 110 mm ($4\frac{3}{8}$ ")



8597

Uncoupling track section · For releasing automatic couplings · Uncoupling ramp is either solenoid-operated or hand lever operated · Length 110 mm ($4\frac{3}{8}$ ")



8598

Isolating track section, straight · With connector terminals · The rail nearer the terminals has a gap half way along it · Length 110 mm ($4\frac{3}{8}$ ")



8599

Switching track section, straight · With connector terminals · To enable moving trains to trigger switching functions · Length 110 mm ($4\frac{3}{8}$ ")



8529

Switching track section, curved · With connector terminals · To enable moving trains to trigger switching functions · Radius 195 mm ($7\frac{3}{4}$ ") · 30°

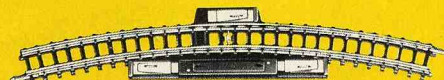

8539

Switching track section, curved · Construction and operation as for 8529, but with radius 220 mm ($8\frac{5}{8}$ ") · 30°

The switching track sections 8529, 8539 and 8599 enable a moving train to control solenoid-operated items automatically. They are actuated by the locomotive, and can trigger different and independent switching functions in each direction. The control pulses are fed out via two terminals insulated from each other.

Track sections

Crossings and turnouts

8559

Crossing · Crossing angle 13° · Length of track sections 112.8 mm (4 1/2") (see Fig. 1)



8560

Double slip switch · Crossing angle 13° · Radius 323 mm (1 ft. 3/4") · The slip points, which are on the inside, are double solenoid-operated by remote control · Additional hand control lever · Length of straight track sections 112.8 mm (4 1/2") · (See Fig. 2 for an example of its installation)

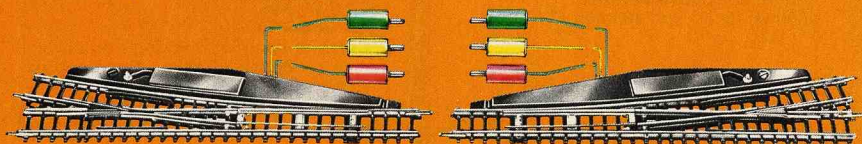
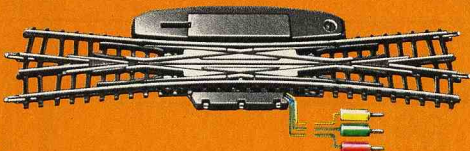

8561

Pair of solenoid-operated turnouts · Consisting of one right-hand and one left-hand turnout, each operated by double

solenoid · Additional hand control lever · Turnout angle 13° · Radius of branch track 490 mm (1 ft. 7 3/8") · Length of through track section 110 mm (4 3/8") · (See Figs. 3 and 4 for examples of turnout installation)



8564

Pair of manually-operated turnouts · Consisting of one right-hand and one left-hand turnout · Operated by hand lever ·

Turnout angle 13° · Radius of branch track 490 mm (1 ft. 7 3/8") · Length of straight track section 110 mm (4 3/8") · (See Figs. 3 and 4 for examples of its installation)

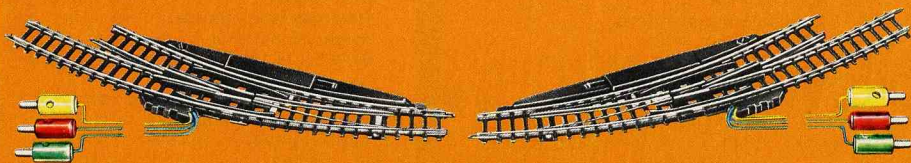

8567

Pair of solenoid-operated curved turnouts · Consisting of one right-hand and one left-hand inner circle turnout · Each

operated by double solenoid · Additional hand control lever · Length and radius of branch track the same as for track section 8521 · Length of through track 125 mm (4 7/8") · (See Fig. 5 for an example of its installation)

1



2



3

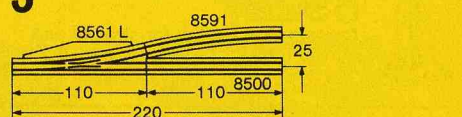

4

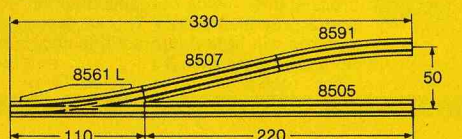

5

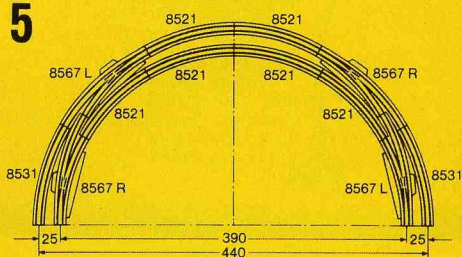

Track accessories

8991

Bumper · For clipping onto the rails · Black · Buffer beam white with red stripe · Length 15 mm (5/8")

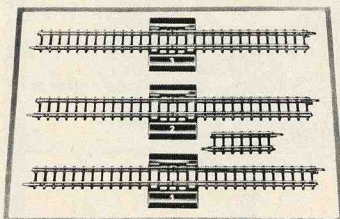

8999

Track fixing rails · 0.5 × 6 mm (1/64" × 1/4") · Pack of 100

8954

Pack with 10 isolating and 20 conducting jointing clips for electrical isolation of tracks or for making a conducting connection between track ends



8993

Reversing loop kit · Consisting of 3 track sections, each 110 mm (4 3/8") long, which are arranged in the sequence of their identifying numbers, and 1 track section 8504 · Allows one-way travel on reversing loops

0208

Track plan stencil for Märklin mini-club tracks · All track sections are marked out in 1:5 scale on the stencil, from which they can easily be reproduced on paper using a sharp pencil

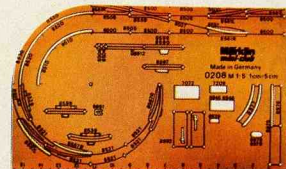

0292

Booklet entitled "Märklin mini-club track layouts" · Illustrated guide for the building of 16 track layouts and catenary systems, connecting up power packs and solenoid-operated items and for building bridges · Contents 54 pages · Size 21 × 30 cm (8 1/4" × 1 ft.) · English text





8911

Mast for overhead line · Basic unit with supporting plate · Height 38 mm (1½")

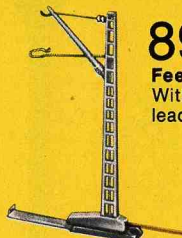

8912

Feeder mast for power supply · With supporting plate and connector lead · Height 38 mm (1½")



8913

Bridge mast for clipping onto the side of bridges and ramp sections · Height 41 mm (1⅝")



8914

Tower mast with recesses for hooking in cross-spans 8924 and 8925 · Base 7 × 13 mm (¼" × ½") · Height 61 mm (2⅜")



8923

Contact line section · Length adjustable between 150 mm (5⅞") and 180 mm (7⅛")

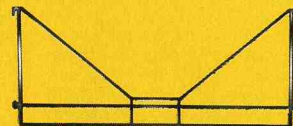

8925

Cross-span · For hooking into tower masts · Spans 3 tracks · Span approx. 72 mm (2⅞")



8922

Contact line section for straight and curved tracks · Length 165 mm (6½")

8924

Cross-span · For hooking into tower masts · Spans 5 tracks · Span approx. 123 mm (4¾")

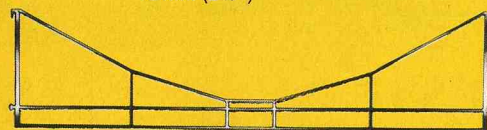

8921

Pack of contact line insulators · For insulating contact line sections from cross-spans · Pack contains 8 white and 2 gray insulators · The white insulators will hold 2 contact line sections, the gray ones 3



8926

Pack of 8 isolating sections and 6 connecting springs · These are required for making isolating points in the overhead line, and at branches above turnouts

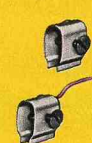

8927

Pack of contact wire terminals · Contains 2 screw terminals with and 3 without leads · For feeding power into catenary sections, or for holding sections of contact line together, e.g. above crossings

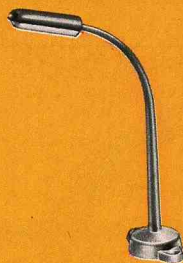

8957

Lamp standard · Height 46 mm (1¾") · Base 8 × 14 mm (¼" × ½")

⚡ = 60210



8958

Station lamp standard · Height 46 mm (1¾") · Base 8 × 14 mm (¼" × ½")

⚡ = 60210



8959

Sidewalk lamp standard · Height 25 mm (1") · Base 8 × 14 mm (¼" × ½")

⚡ = 60210



8973

Pack containing various miniature automobiles



8974

Re-railing ramp · Made of plastic · Makes it easier to set locomotives or cars on the track · Length 140 mm (5½") · Height 13.5 mm (½")



8955

Pantograph current collector with one fixing screw

8987

Pair of carbon brushes for locomotives 8800, 8803, 8864 and 8895

8988

Pair of carbon brushes for locomotives 8802, 8816, 8854, 8857, 8858, 8874 and 8875

8989

Pair of carbon brushes for locomotives 8827, 8842, 8885, 8891 and 8893



8950

Light fitting with lamp insert and lead · For stations, buildings, etc

⚡ = 8953



8953

Lamp insert · With 10 V bulb · For use in light fitting 8950, signal 8939, grade crossing 8992 and in locomotives which can take lighting



7199

Bottle of oil · Contains about 10 cu.cm. (1 fluid ounce) of oil which is suitable for lubricating locomotives and cars

60210

Light bulb for items 8957, 8958 and 8959

Accessories Power packs

Usual colors of electrical leads in Märklin circuits:

7100

Lead · Single core · Gray · 10 m (33 ft.) · Gray = a. Lead for lighting voltage, from lighting units to the gray socket (0) on the power pack.
b. Lead from control box or switching track section to the gray socket (0) on the power pack.
c. Extension of red and green leads between signals and the signal control panel.

7101

Lead · Single core · Blue · 10 m (33 ft.) · Blue = Lead from solenoid-operated items to the control box or switching track section.

7102

Lead · Single core · Brown · 10 m (33 ft.) · Brown = Lead for traction voltage, from the feeder track section to the brown socket (01) on the power pack.

7103

Lead · Single core · Yellow · 10 m (33 ft.) · Yellow = Lead for lighting voltage, from lighting units and solenoid-operated items to the yellow socket (L1) on the power pack.

7105

Lead · Single core · Red · 10 m (33 ft.) · Red = a. Lead for traction voltage, from the feeder track section to the red socket (B1) on the power pack.
b. Leads for connecting isolating track sections to the signal control panel or the control box.

Electrical leads

The copper conductor in these stranded leads consists of 24 separate strands each of 0.10 mm (0.004") diameter, giving an overall cross-sectional area of 0.19 mm² (0.03 sq. "). That is more than enough to cope even with a short circuit current flowing through a 40 VA transformer.

Sleeves



7111 = brown
7112 = yellow
7113 = green
7114 = orange
7115 = red
7117 = gray

Plugs with side sockets



7131 = brown
7132 = yellow
7133 = green
7134 = orange
7135 = red
7137 = gray

7000



Staples · Bag of 50 · For fixing leads to a wooden base

7599



Countersunk wood screws for fixing bridge sections onto bridge piers · Pack of 200



7072

Control box with 8 sockets for connecting 4 double solenoid-operated articles · The position of signals, turnouts etc. can be seen from the position of the push buttons · Length 80 mm (3 1/8") · Width 40 mm (1 3/4")



7210

Control box with 4 sockets for distributing traction or lighting current to 4 circuits, with push button selection · Length 80 mm (3 1/8") · Width 40 mm (1 3/4")

Circuit diagram of 7210 (with switch 3 closed)

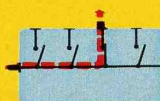

7211

Control panel with 8 sockets, for switching 4 different traction or lighting circuits on or off by means of push buttons · Length 80 mm (3 1/8") · Width 40 mm (1 3/4")

Circuit diagram of 7211 (with switch 3 closed)

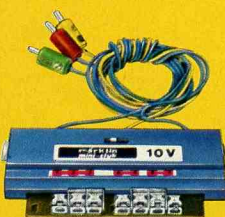

8945

Universal remote control switch with 2 single-pole switches and one changeover switch for various circuits · The universal remote control switch can be given a variety of functions to perform (up to 3 simultaneously) and it will perform them automatically · It can control grade crossings, for example, and lighting installations, and many other things · Examples of applications are shown in booklet 0292 (see page 89) and in the Märklin mini-club guide · Operating voltage 10 V · Double solenoid-operation · Can be operated by a switching track section, a turnout control box or by means of the hand control lever · Width 30 mm (1 3/16") · Length 70 mm (2 3/4") · Height 8 mm (1/4")



8946

Manual signal control panel with 2 single-pole switches and one changeover switch, which can be used, for example, to control the sequence of lights in signal 8939 and to control the traction current · Width 30 mm (1 3/16") · Length 70 mm (2 3/4") · Height 8 mm (1/4")

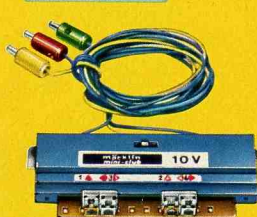

8947

Double-pole changeover switch (polarity reversing switch) · Operating voltage 10 V · Double solenoid operation · Can be operated by a switching track section, a turnout control box or by means of the hand control lever · Width 30 mm (1 3/16") · Length 70 mm (2 3/4") · Height 8 mm (1/4")



7209

Distribution strip · With 11 single sockets · Size 50 x 20 mm (2" x 3/4")



7229

Distribution strip with 5 lead terminals, permanently connected together · Length 38 mm (1 1/2") · Width 10 mm (3/8")

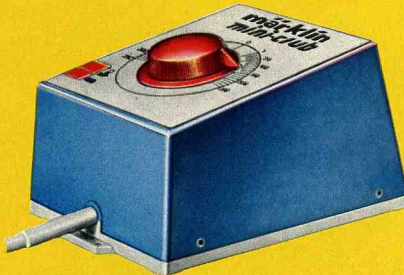

6711

220 Volt

Märklin mini-club power pack for use with AC power supply · Single knob control for adjusting the **traction voltage (DC)** between 0 and 8 V and for determining the direction of travel by turning clockwise or anticlockwise from its central position · Power output in the traction circuit up to 8 VA, and in the **lighting circuit (AC)** about 12 VA at 10 V · Blue plastic case · Weight 1.65 kg · Dimensions 155 x 110 x 88 mm (6 1/8" x 4 3/16" x 3 1/2")

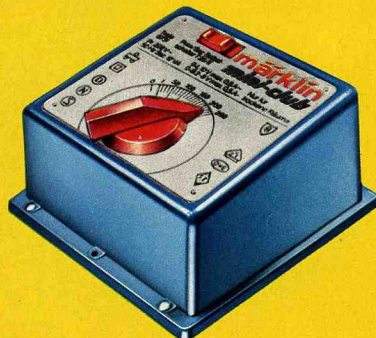

6720

100 Volt Japan

6727

110 Volt USA (60 Hz)

6729

240 Volt England

6731

220 Volt

Märklin mini-club power pack for use with AC power supply · Output 12 VA · **Traction voltage (DC)** adjustable between 2 V and 8 V · Polarity reversing switch for selecting the direction of travel · **Lighting voltage (AC)** 10 V · Blue plastic case · Weight 1.2 kg · Dimensions 125 x 135 x 75 mm (5" x 5 3/8" x 3")

märklin
I



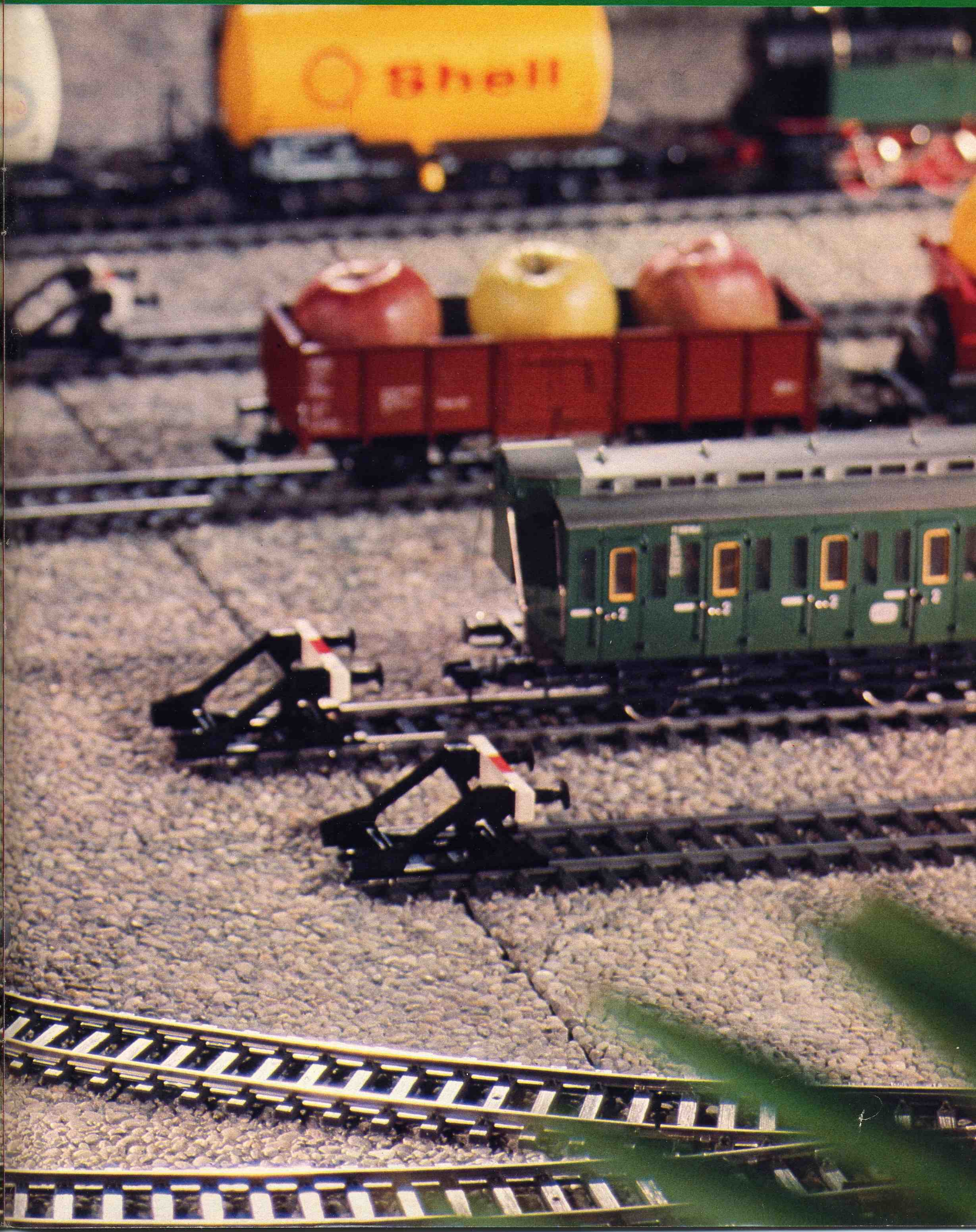

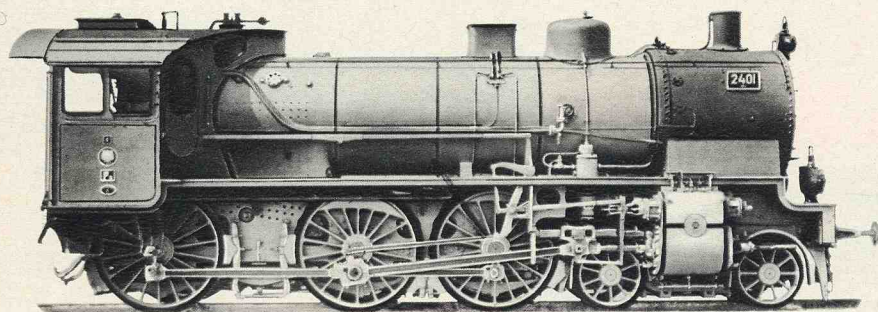

The first P8 "Cöln 2401", with streamlined driver's cab (as when it was delivered, in 1906).

The first passenger train locomotive of the new P8 family was delivered by the Firm of Schwartzkopff, in Berlin, to the Royal Prussian Railways in 1906. The reliability and good performance of this type made it the workhorse of the railways, and it was used both for express and for local passenger services.

This versatility caused the P8 to be one of the most extensively produced locomotives in the world. Altogether 3800 locomotives were produced, which in the course of time received

a great number of modifications to the original design.

The last scheduled journey by a P8 in the Federal Republic of Germany took place in May 1972, the train being the express from Freudenstadt to Eutingen.

In 1919 the purchase price of a P8 was 92.600 Reichsmark.

Locomotive with tender
for two-rail AC operation

5799 new

Locomotive with tender · A model of the German Federal Railways' 4-6-0 class 38 locomotive · 3 axles driven through concealed gears · Ball bearings on each side for the armature shaft · 2 non-skid tires · Simulated Heusinger reversing gear · Die cast zinc frame · Mat black body with large smoke deflector plates and detailed representation of the fittings on the boiler and in the driver's cab · Forward or reverse drive switched by electronic control · Built-in smoke set · Three lights on locomotive and tender which burn with constant brightness whether the train is stationary or in motion · 8 wheeled tender with 2 trucks · Coal box filled with real coal · Sprung buffers and imitation brake hoses on both buffer beams · Scale model screw coupling in front, which can be replaced by an automatic claw coupling · Automatic claw coupling on the tender · Illuminated driver's cab · Figures of driver and fireman included · Length over buffers 58 cm (1 ft. 11")

Bulb	= 60019
Pair of carbon brushes	= 60146
Smoke fluid	= 0241

This model will not run on track sections where the radius of curvature is less than 1 m (3 ft. 3"). Suitable track sections are 5932 and turnouts 5972 and 5973.



Details of the P8

Driver and fireman

Driver's cab illumination

Fittings on the boiler and in the driver's cab

Real coal

Plug and socket connection between locomotive and tender

Pipework distinct from boiler

Smoke set

Electronic direction-control switch

Ball bearings (each side) for armature shaft

Constant-brightness lights even when stationary

Concealed gears (locomotive closed underneath)

Imitation brake hoses

Original coupling in front (can be replaced by an ordinary coupling)

Sprung buffers

German Federal Railways' class 38

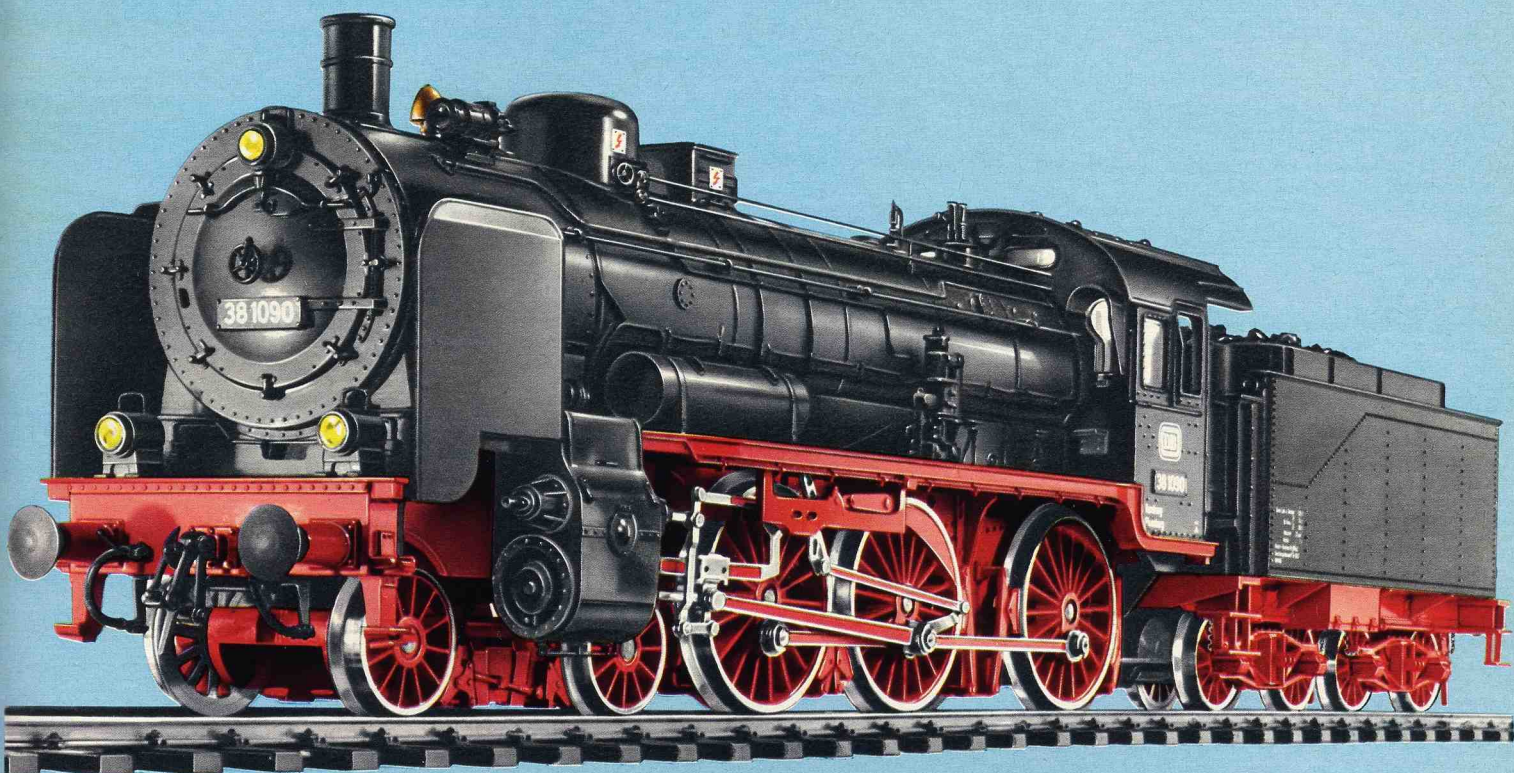

5797 **new**

Locomotive with tender · The same model as 5799, but with electronic noise maker and whistle arrangement · The electronic noise maker in the tender produces realistic exhaust noises · The locomotive can be caused to whistle at any desired point of the layout by means of special magnets placed in the track · Two of these magnets are provided

5749 **new**

Locomotive with tender · The same model as 5799, but arranged for 2-rail DC operation

5747 **new**

Locomotive with tender · The same model as 5797, but arranged for 2-rail DC operation

The power source for 1 gauge alternating current locomotives is a Märklin transformer 6620-6631 (see page 69). For outdoor 1 gauge layouts, electronic power pack 6699 (see page 105) is also required.

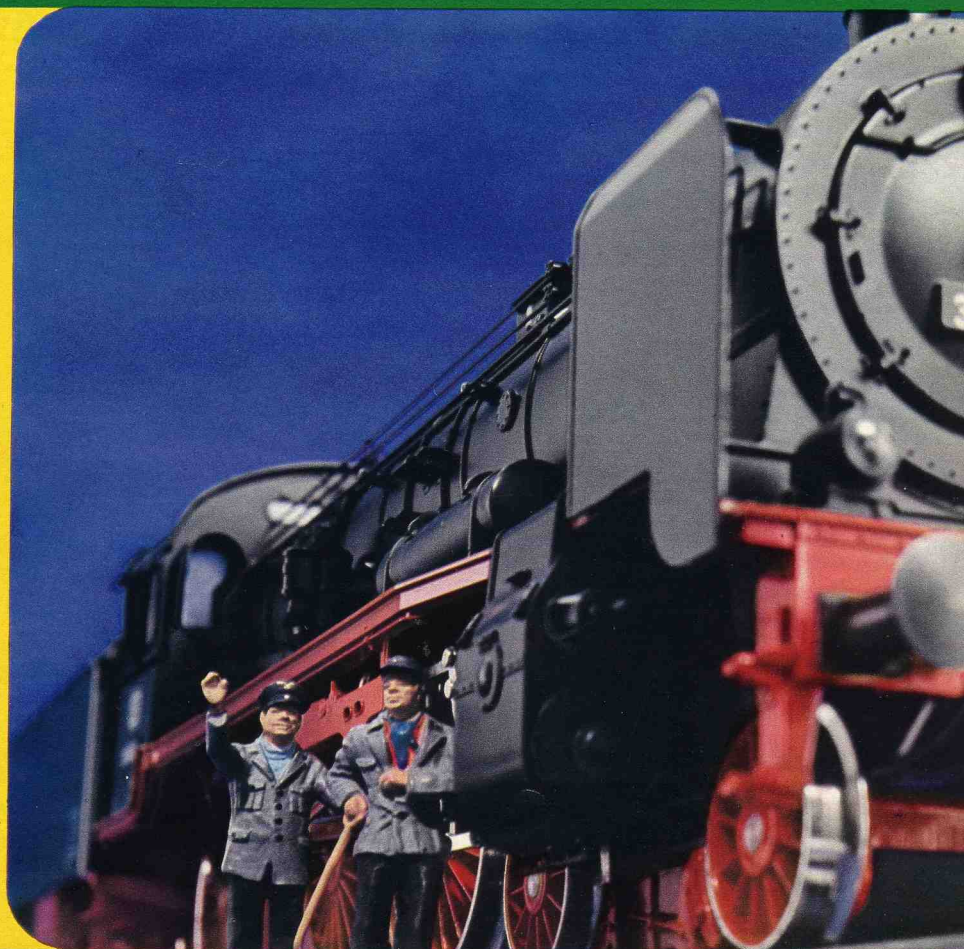

Train sets

5500

Freight train (without transformer) · With tank locomotive 5700, 1 open freight car 5850, 1 dump car 5859, 2 straight track 5900, 12 curved track sections 5921 and 1 connector kit 5604 · Length of train 97 cm (3 ft. 2 1/4")

5520

Freight train (without transformer) · The same set as 5500 but with diesel locomotive 5720



Tank locomotive

5702

Tank locomotive · Wheel arrangement 0-6-0 · 2 non-skid tires · Simulated Heusinger reversing gear · Remote control for forward and reverse drive · 3 working headlights at each end · Body, black boiler, dark green water tanks and cab, brass-colored window frames and hand rails · Driver's cab doors will open · Windows with "Cellon" panes · Die cast zinc frame · Automatic claw coupling and sprung buffers at each end · Length over buffers 30.25 cm (1 ft.)

Bulb = 60015
Pair of carbon brushes = 60041



Tank locomotive

5700

Tank locomotive · A model of the German Federal Railways' 0-6-0 class 80 locomotive · 2 non-skid tires · Simulated Heusinger reversing gear · Remote control for forward and reverse drive · 3 working headlights at each end · Mat black body · Driver's cab doors will open · Windows with "Cellon" panes · Die cast zinc frame · Automatic claw coupling and sprung buffers at each end · Length over buffers 30.25 cm (1 ft.)

Bulb = 60015
Pair of carbon brushes = 60041

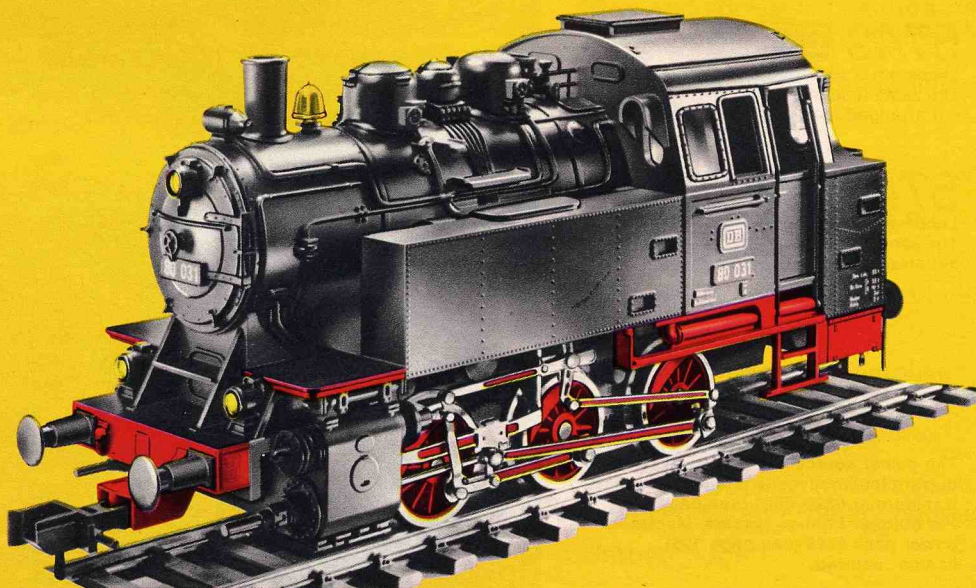

Locomotives

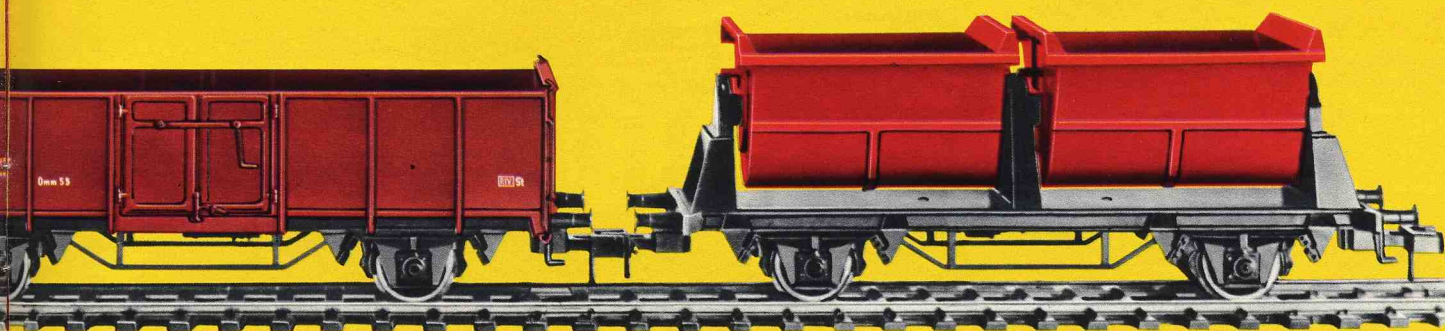

Diesel locomotive

5720

Diesel locomotive · A model of a 0-6-0 industrial locomotive · 2 non-skid tires · Remote control for forward and reverse drive · 3 working headlights at each end · Red body with two yellow horizontal stripes · Driver's cab doors will open · Windows with "Cellon" panes · Die cast zinc frame · Automatic claw coupling and sprung buffers at each end · Length over buffers 30.25 cm (1 ft.)

Bulb = 60015
Pair of carbon brushes = 60041

The power source for I gauge alternating current locomotives is a Märklin transformer 6620-6631 (see page 69). For outdoor I gauge layouts, electronic power pack 6699 (see page 105) is also required.

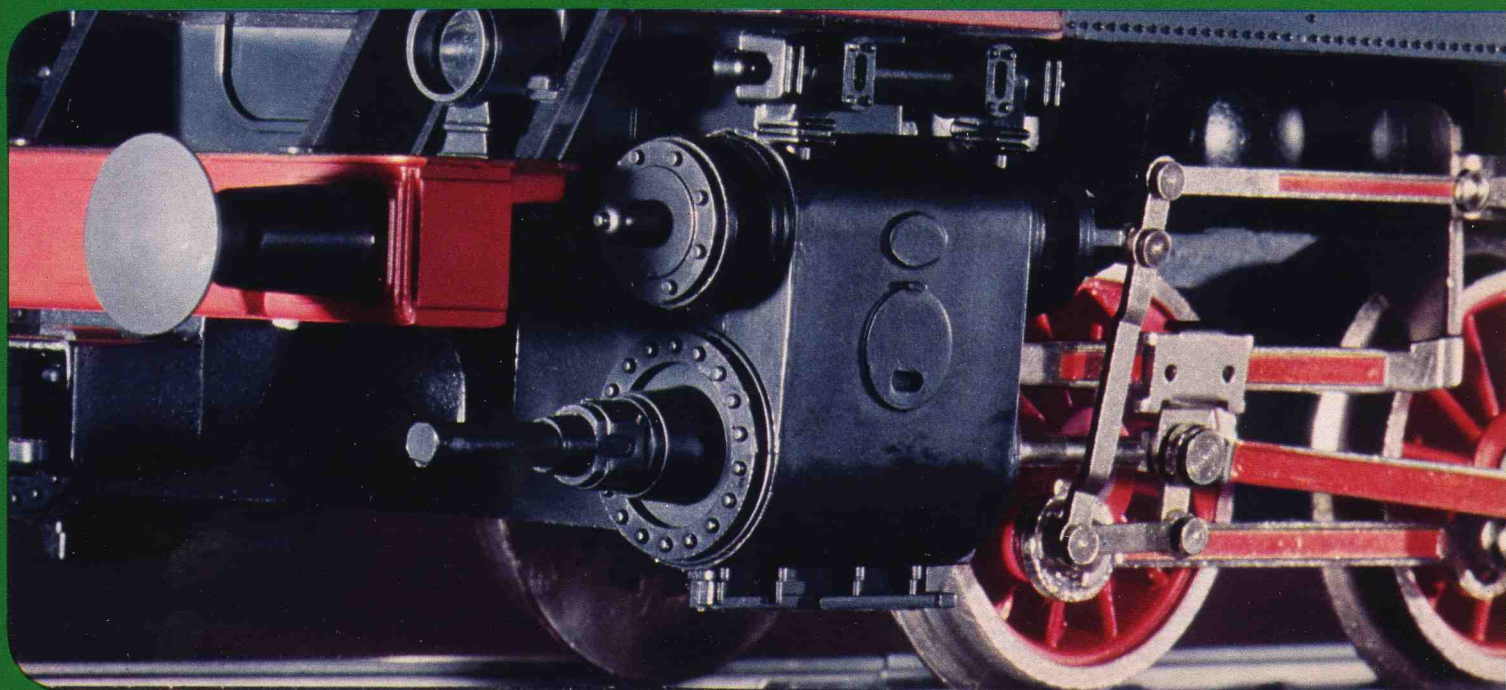

5804 new

Compartment car · 2nd class · A model of the German Federal Railways' type B3pr07 · 3 axles · Steering axles controlled via center axle · Sprung buffers · All doors will open · Windows inset in plastic frames · Interior fittings · Roof can be taken off · Length 39.1 cm (1 ft. 3³/₈"') · Can be fitted with interior lighting set 5605 (see page 105)

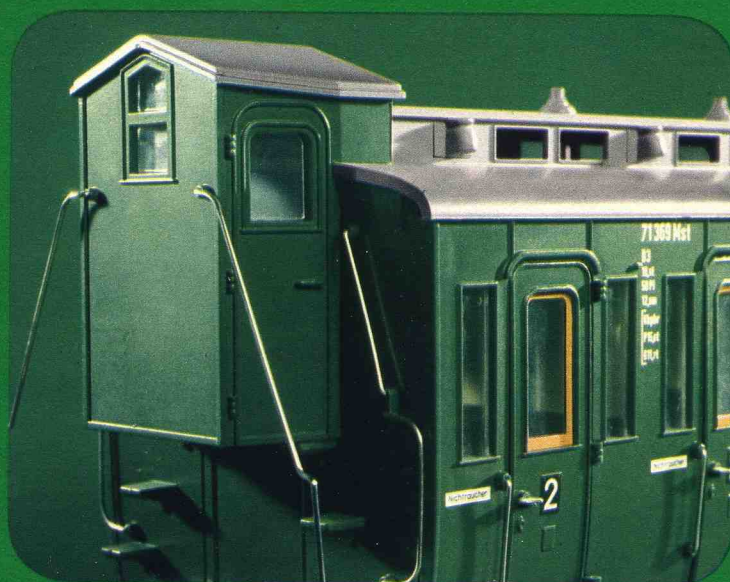
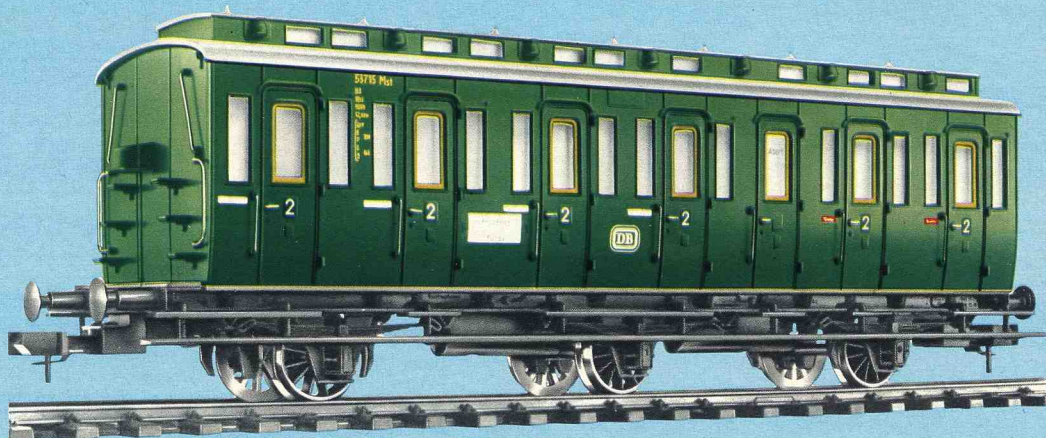

5805 new

Compartment car with brake-man's cab · 2nd class · A model of the German Federal Railways' type B3pr07 · 3 axles · Steering axles controlled via center axle · Sprung buffers · Doors will open · Windows inset in plastic frames · Interior fittings · Roof can be taken off · Length 39.1 cm (1 ft. 3³/₈"') · Can be fitted with interior lighting set 5605 (see page 105)



Doors will open
Sprung buffers
Interior fittings



Passenger cars with interior fittings



5800

Passenger car · Modeled on a private railroad coach · 2 doors which will open · Dummy ventilators on roof · Windows inset in plastic frames · Interior fittings representing wooden seats · Length 31 cm (1 ft. 1/4")

5801

Passenger car · Modeled on a car used by the former Royal Württemberg Railways · Green finish, otherwise similar in design to 5800



Freight cars

5850

Open freight car · A model of the German Federal Railways' type Omm 55 · Length 31 cm (1 ft. 1/4")



5851

Open freight car · A model of a Belgian State Railways' (SNCB) freight car · Length 31 cm (1 ft. 1/4")

5853

Flat car · With removable stanchions · Length 31 cm (1 ft. 1/4")

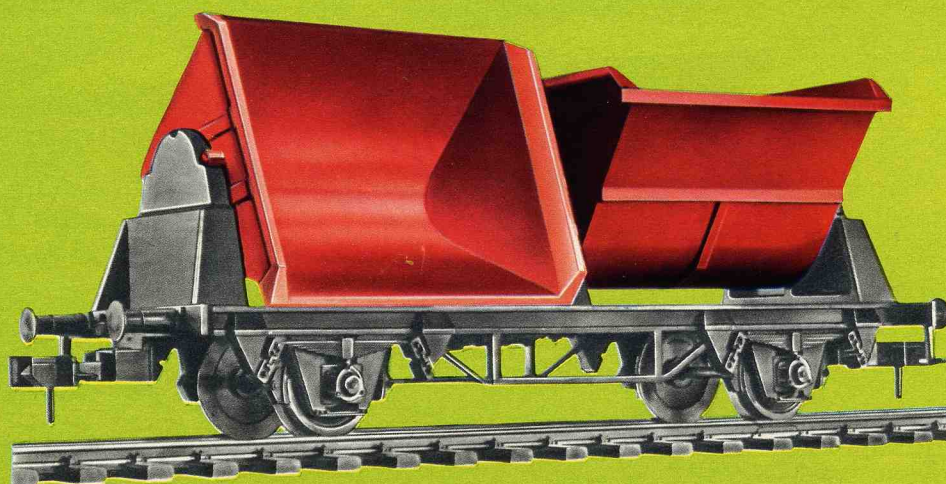
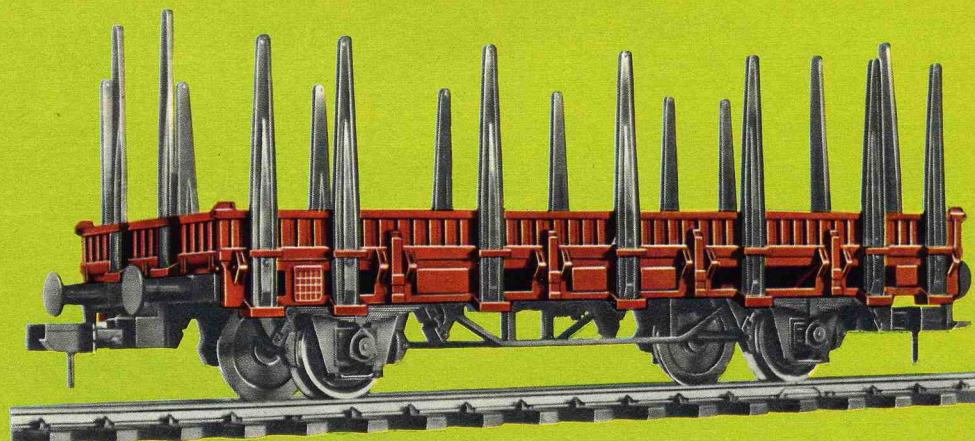

5859

Dump car · 2 independent hoppers dump to either side · Latch holds hoppers in upright position · Length 31 cm (1 ft. 1/4")

the most realistic model
railroad there is

5861

Beer car · A model of a car owned by the Dortmund Union Brewery · Doors on each side which will open · Length 31 cm (1 ft. 1/4")

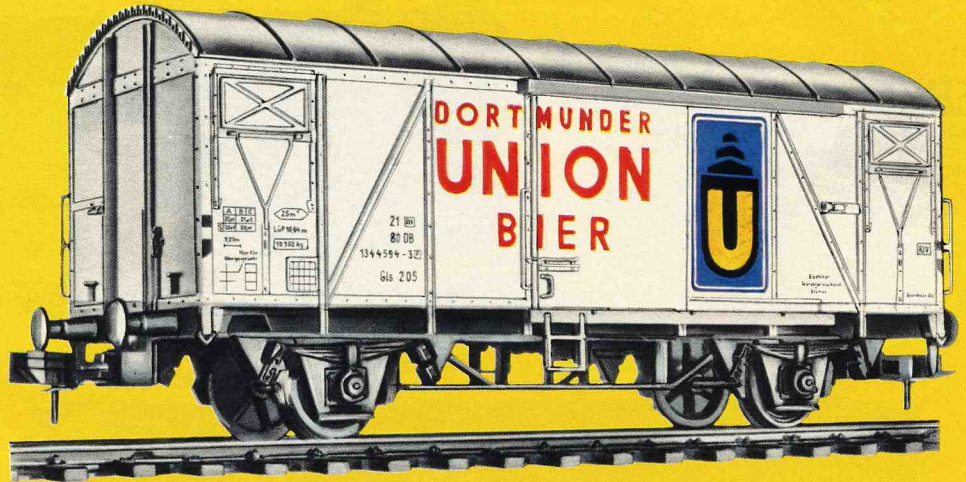

5863

Beer car · A model of a car owned by the Haller Löwenbräu Brewery · Doors on each side which will open · Length 31 cm (1 ft. 1/4")



5864

Beer car · A model of a car owned by the Kulmbacher Mönchshof Brewery · Doors on each side which will open · Length 31 cm (1 ft. 1/4")



Working models of freight cars

5860

Box car · A model of the German Federal Railways' type G1s · Doors on each side which will open · Length 31 cm (1 ft. 1/4")

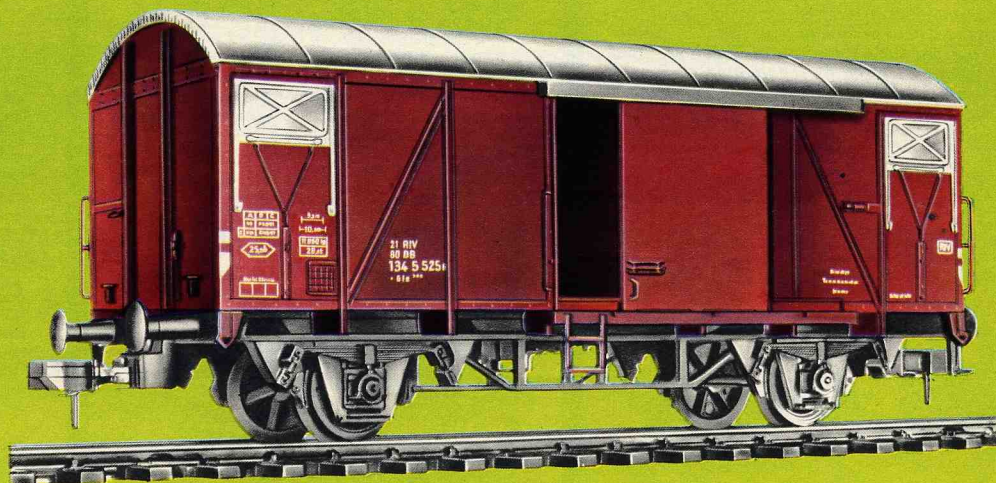

5865

Tank car · Esso · With filler cap and discharge valve which open and close, brakeman's stand, ladder and walkway · Length 31 cm (1 ft. 1/4")



5866

Tank car · Shell · With filler cap and discharge valve which open and close, brakeman's stand, ladder and walkway · Length 31 cm (1 ft. 1/4")



Track sections for use in or out of doors

Track sections

The rails, which are mounted on plastic cross-ties and insulated from each other, act both as wheel guides and as conductors for the current supply and return. Track sections are joined together by rail jointing clips and also by a clip on the tie strip.

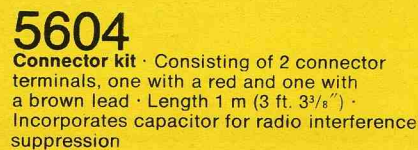
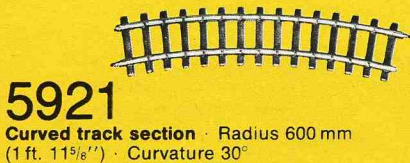
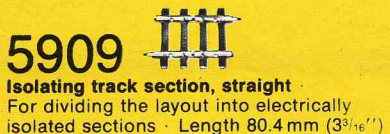
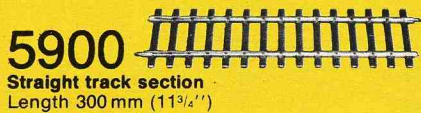

Although a two-rail conductor system is used, no polarity problems arise even when reversing loops, diagonals or Y-tracks are assembled. This large scale Märklin railroad uses AC motors, sharing the advantages of this technique with the HO gauge system. As with the HO gauge, the direction of travel is switched by the "driver" built-in to the locomotive.

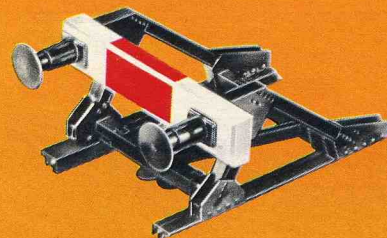
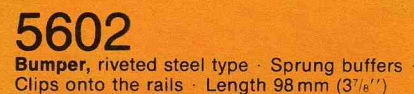

The rails are made of solid, stainless, corrosion-resistant material so that you can even lay them in your yard. Outer diameter of a small track circle is 1.28 m (4 ft. 2¹/₈"') and that of a large track circle is 2.12 m (6 ft. 11¹/₂"').

This diagram shows the two Märklin I gauge track circles, with their radii, distances apart and curvatures.

1 circle 5921 = 12 track sections
1 circle 5932 = 16 track sections

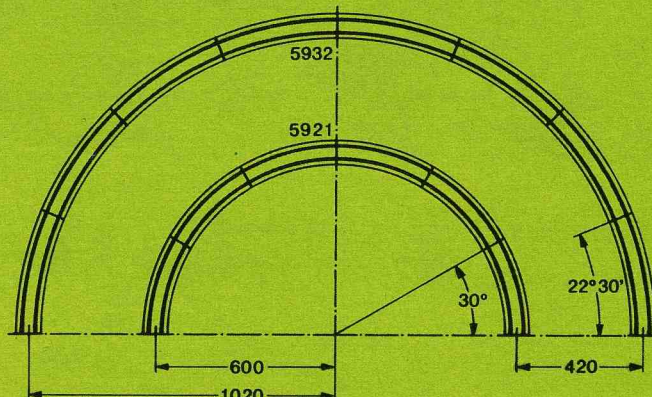

Märklin I gauge, the large scale railroad for use in or out of doors



5611

Home signal with one semaphore arm · Color lights change from red to green · Operated by double solenoid and can control trains · 2 connector terminals, 2 leads and insulators for 6 isolating points are included · Height 26.5 cm (10¹/₈"') · Width 6 cm (2³/₈"') · Length 11 cm (4³/₈"')

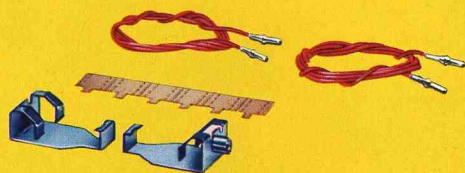

5605 **new**

Interior lighting set for cars 5804 and 5805 · Consists of two current pick-ups, 3 lighting units, leads and plugs · Installation instructions are included

= 49342 = 60000



6699 **new**

Power pack for use in or out of doors · For connection to Märklin lighting transformer 6611 or to the lighting sockets of a Märklin transformer with 30 VA output power · Lighting voltage 16 V · Electronic control of locomotive speed and direction of motion · Maximum permitted load 1.8 Amperes · Plastic case · Weight 315 grammes · Dimensions 125 x 135 x 55 mm (5" x 5¹/₁₆" x 2¹/₁₆"') · Use Märklin leads and plugs (see page 68) to extend connector leads if required



This power pack also enables locomotives to be run extremely slowly.

In conjunction with 6611 and 6620-6631 this power pack makes it possible to operate the railroad out of doors.

Transformers and remote-control accessories will be found on pages 68 and 69.

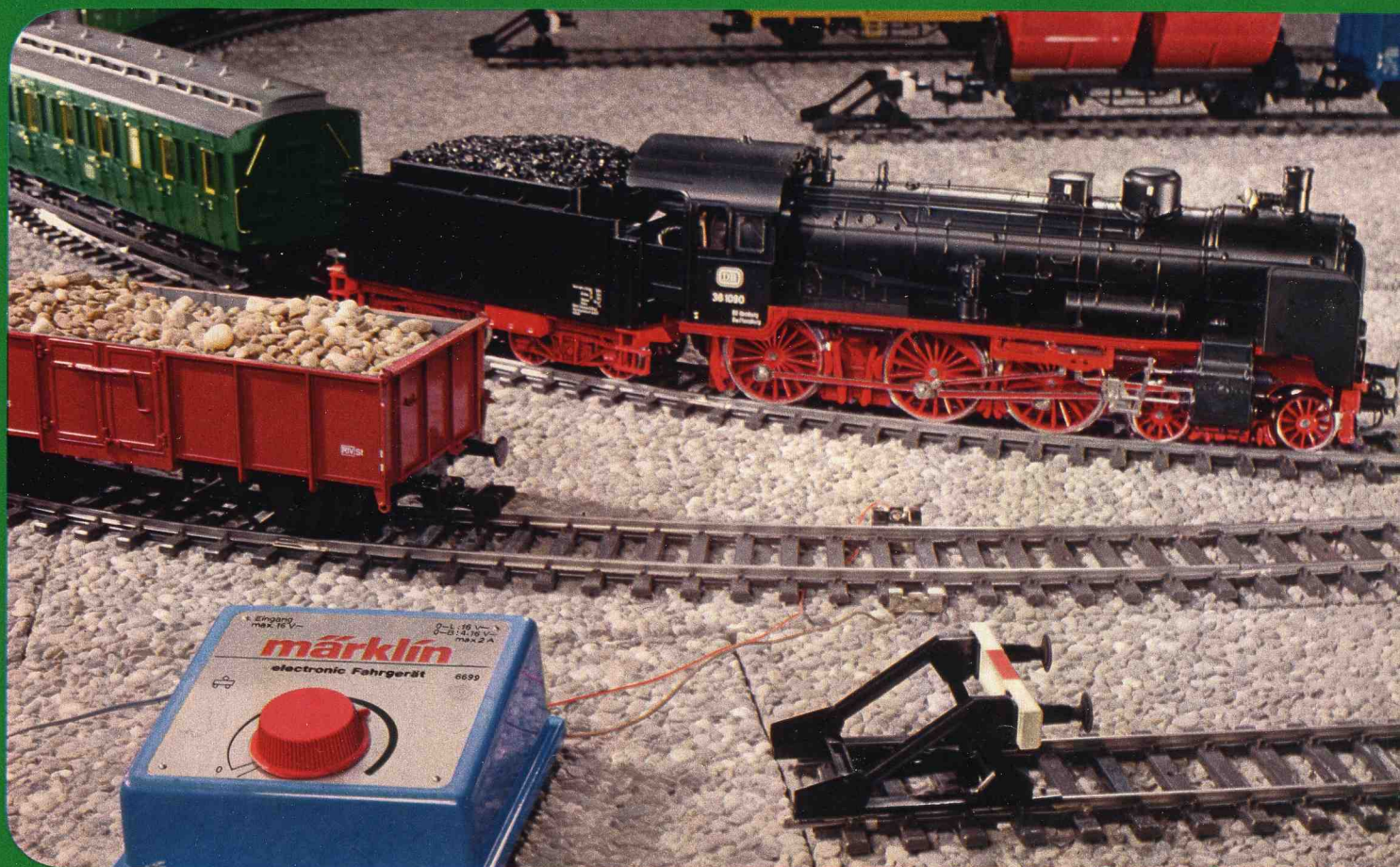



Automobile race track Scale 1:32

Gift packs for beginners

Märklin sprint, the high speed race track system with the most advanced technical features

The distinctive features of Märklin sprint are the thoroughly planned design of the whole system, its compact scale and the many extra details. Front axle steering gives the Märklin racing automobiles excellent cornering characteristics. Skid-type electrical pickups with compensating suspensions ensure that reliable contact is made with the track and clean themselves and the feeder rails at the same time. The high speed Märklin motors are located to give a good center of gravity position, and their technical excellence will be appreciated

by connoisseurs. Attached to the motors are gear-boxes with gear ratios designed to give the automobiles maximum sensitivity to changes in traction voltage, so that sharp braking can be applied **before** entering a curve and rapid acceleration while **in** the curve.

The speed controller lead can be connected to the track at the point which seems to the "driver" to be tactically most favorable.

The speed controllers provide infinitely variable speed control (1591 also provides stepped speed control). And one particularly good point: the Märklin automobile race track can be assembled the same way as it used—at high speed and without problems.

The use of hinged locking couplings and electrical sprung contacts enables a robust and reliable race track to be assembled quickly. Although no retaining clips are used, the track will stand up well to prolonged hard racing.

The track can be extended from two-lane to four- or six-lane, it can have long straight sections or many banked or unbanked curves; and inclines, overpasses and lane cross-overs with or without automatic braking sections can be constructed. Lap counters can be used to indicate how many laps the race has run.

Märklin racing brings the tension of the great international automobile racing events into the home. It's quite an experience to drive one of the high-speed Märklin racers in competition.

It is best to start with the Märklin sprint automobile race track set 1409. This contains two top quality racing automobiles (Porsche Can Am 917/10), a race track with a variety of features such as straight sections, banked and unbanked curves, as well as crash barriers with their supports, piers, and speed controllers.



Märklin sprint automobile race tracks are fitted with radio interference suppressors to comply with regulations, and are marked to that effect.

1400

87.5 × 45 cm (2 ft. 10½" × 1 ft. 5¾")

Race track set · Contains 2 McNamara racing automobiles, 1 red and 1 gray speed controller, 2 straight course sections 1205, 4 curved course sections 1220, crash barrier and 20 crash barrier supports · These parts will make up an oval circuit · Full instructions are included

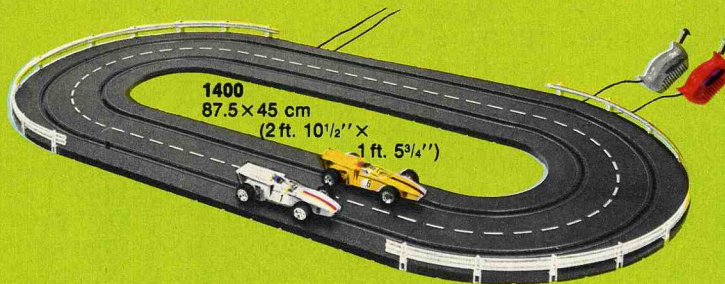

1400
87.5 × 45 cm
(2 ft. 10½" ×
1 ft. 5¾")

1409

140 × 87.5 cm (4 ft. 7⅛" × 2 ft. 10½")

Race track set with 1 banked curve · Contains 2 Porsche Can Am 917/10 sports cars, 1 red and 1 gray speed controller, 2 straight course sections 1200, 2 straight course sections 1201, 2 straight course sections 1206, 3 curved course sections 1220, 2 curved course sections 1241, 4 banked curve sections 1248, crash barriers, 19 crash barrier supports, 2 piers and 1 jointing section 1547 · These parts will make up a figure-eight course with overpass and 1 banked curve · Full instructions are included

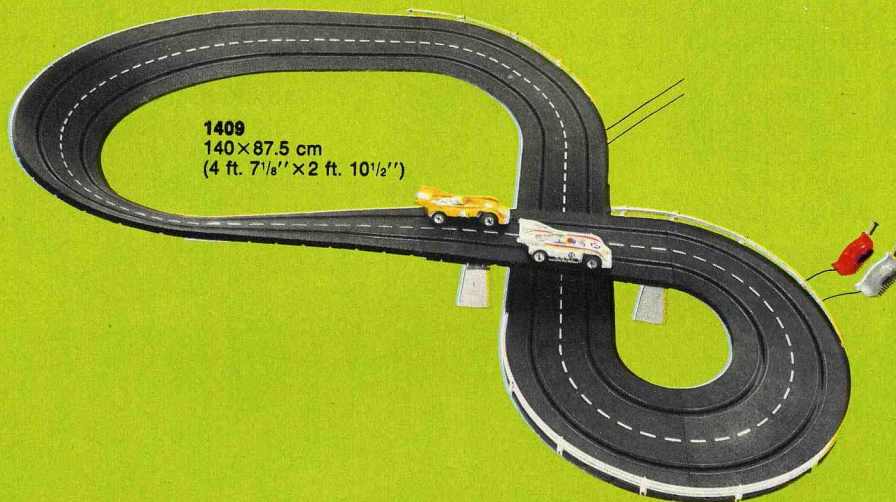

1409
140 × 87.5 cm
(4 ft. 7⅛" × 2 ft. 10½")

1412

220 × 82 cm (7 ft. 2⅝" × 2 ft. 8¼")

Race track set with 1 banked curve · Contains 2 Porsche 935 sports cars, 1 red and 1 gray speed controller, 1 straight course section 1200, 1 straight course section 1201, 4 straight course sections 1205, 1 straight course section 1206, 8 curved course sections 1241, 4 banked curve sections 1248, crash barriers, 30 crash barrier supports, 4 piers and 1 jointing section 1547 · These parts will make up a figure-eight course with overpass and 1 banked curve · Full instructions are included



1412
220 × 82 cm
(7 ft. 2⅝" × 2 ft. 8¼")

Racing and sports cars 1:32

Racing cars for experts

The front wheels are steered by slots in the course. Accurate reproduction of suspension arm assembly. Current pick-up by 2 sprung skids.

1326 **new**

Sports car · A model of the BMW 320 i RC · Driven through spur gears · Multi-colored plastic body · Inset windows · Length 13.5 cm (5³/₁₆"') · Spare tires for this automobile 1505



1327 **new**

Sports car · A model of the Porsche 936 · Driven through spur gears · White plastic body · Length 13.2 cm (5³/₁₆"') · Spare tires for this automobile 1505

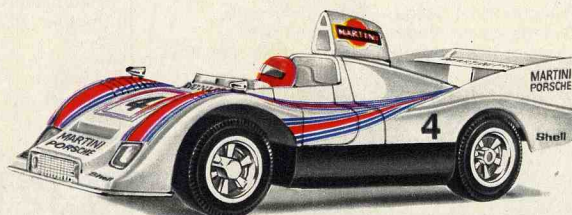

Porsche 936 – winner of the Le Mans 1977 race

1328 **new**

Sports car · Technical details the same as for 1327, but bodywork black



1329 **new**

Sports car · A model of the Porsche Can Am 917/10 · Driven through spur gears · Green plastic body · Open cockpit with windshield · Length 13.4 cm (5¹/₄"') · Spare tires for this automobile 1505



1300

Formula racing automobile · A model of the Mercedes W 196 Monoposto · Driven through multiratio gearbox · Silver-colored plastic body · Length 12.8 cm (5¹/₁₆"') · Spare tires for this automobile: front 1500, rear 1501



1301

Formula racing automobile · A model of the Ferrari Supersqualo · Driven through multiratio gearbox · Red plastic body · Length 12.5 cm (5") · Spare tires for this automobile: front 1500, rear 1501





1308

Sports car · A model of the E-type Jaguar · Swing front axle · Driven through spur gears · Red plastic body · Inset windows · Length 13.4 cm (5¹/₄"') · Spare tires for this automobile: front 1500, rear 1503



1310

Sports car · A model of the Porsche 911 T Targa · Swing front axle · Driven through spur gears · Orange plastic body · Inset windows · Length 12.9 cm (5") · Spare tires for this automobile: front 1500, rear 1503

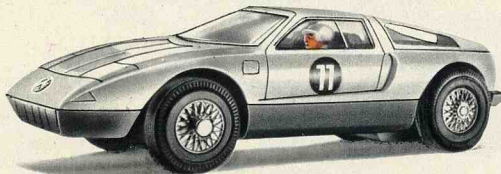

1311

Sports car · A model of the Mercedes C 111 · Swing front axle · Driven through spur gears · White body · Black chassis · Inset windows · Length 12 cm (4³/₄"') · Spare tires for this automobile: front 1500, rear 1503



1312

Sports car · Same design as 1311 · But with orange body

⚡ = 60000



1316

Sports car · A model of the Porsche Carrera 6 · Driven through multiratio gearbox · Silver-colored plastic body · 2 working headlights · Cockpit covered with transparent plastic canopy · Length 13 cm (5¹/₈"') · Spare tires for this automobile: front 1500, rear 1503

⚡ = 60000



1317

Sports car · Same design as 1316, but with open cockpit with windshield · Red plastic body · Length 13 cm (5¹/₈"')

⚡ = 60209

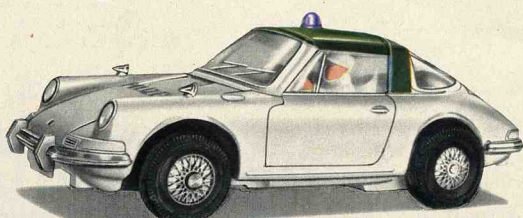

1318

Sports car · Porsche 911 T Targa as police car · **Continuously operating flashing blue light** · Swing front axle · Driven through spur gears · Green and white plastic body · Inset windows · Length 12.9 cm (5¹/₈"') · Spare tires for this automobile: front 1500, rear 1503



1319

Racing automobile · A model of the McNamara · Driven through spur gears · Yellow plastic body · Length 12.3 cm (4⁷/₈"') · Spare tires for this automobile: 1505



1320

Racing automobile · A model of the Lola T222 · Driven through spur gears · Red plastic body · Length 12.7 cm (5") · Spare tires for this automobile: 1505



1321

Sports car · A model of the Porsche CanAm 917/10 · Driven through spur gears · White plastic body · Open cockpit with windshield · Length 13.4 cm (5¹/₄"') · Spare tires for this automobile: 1505



1322

Sports car · A model of the BMW 2002 turbo · Driven through spur gears · Orange plastic body · Length 12.6 cm (5") · Spare tires for this automobile: 1505



1323

Sports car · Same design as 1322 · But with white body



1324

Sports car · A model of the Porsche 935 · Driven through spur gears · White plastic body with stabilizer surface fitted at rear end · Length 14.5 cm (5³/₈"') · Spare tires for this automobile: 1505



1325

Sports car · Same design as 1324 · But with red body

Course sections 1:32

Straight course sections

Double lane · 1200, 1201, 1205 and 1206 can be used for power supply connection

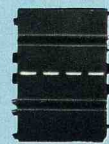
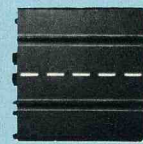
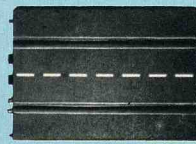
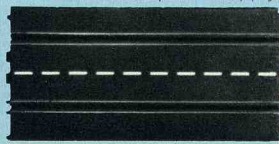
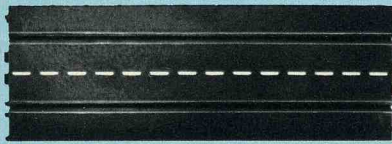

1205

Length 424.2 mm (1 ft. 4³/₄"')
(twice the length of 1200)

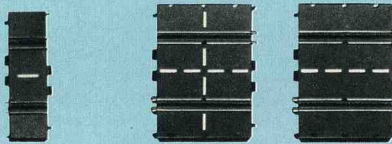

1206

Length 300 mm (11¹³/₁₆"')
(twice the length of 1201)

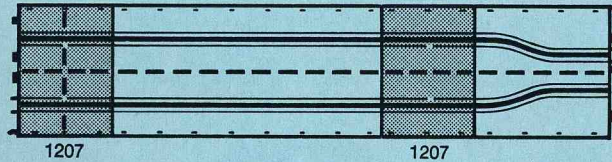

1200

Length 212.1 mm
(8³/₈"')

1201

Length 150 mm
(6")

1202

Length 106 mm
(4³/₁₆"')

1203

Length 62.1 mm
(2⁷/₁₆"')

All course sections are made of rigid plastic and have inset channels for steering the automobiles. Current is supplied to the vehicles by contact rails on each side of the channels. The locking hinge couplings are all that is required to ensure an absolutely positive joint between course sections. The sections are black with a broken white line in the center.

1204 1207

Length 44 mm
(1³/₄"')

Controlled zone kit · Consists of two course sections each 106 mm (4³/₁₆"') long · For use at approach to bottlenecks or lane crossovers · The first vehicle into

the controlled zone automatically cuts off the current in the other lane, and only switches it on again as it leaves the controlled zone

Straight bottleneck

1216

Straight bottleneck · Double lane · Track separation reduces from 75 mm (3") to 38 mm (1¹/₂"') · Length 150 mm (6") · **Two of these course sections are required**

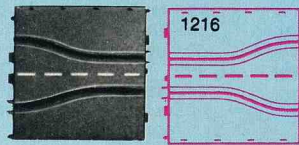

Straight lane crossover

Crossover sections 1217 cannot be used singly · They are used in pairs.

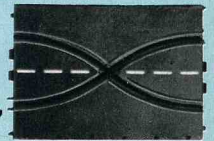

1217

Length 212.1 mm (8³/₈"') · Double lane · The current feeders are isolated electrically where they cross over

Curved course sections

1220, 1241 and 1261 can be used for power supply connection



1220

90° curved course section · Double lane · Mean radius 150 mm (6")

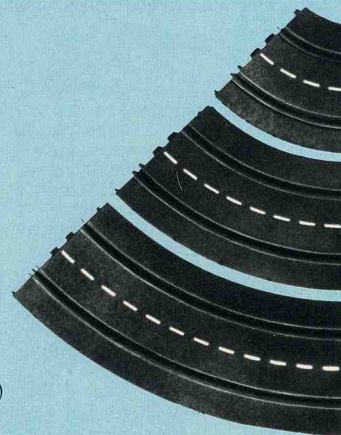

1221

45° curved course section · Double lane · Mean radius 150 mm (6")

1241

45° curved course section · Double lane · Mean radius 300 mm (11¹³/₁₆"')

1261

45° curved course section · Double lane · Mean radius 450 mm (1 ft. 5³/₄"')

45° banked curve course sections

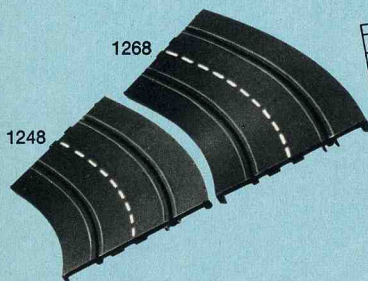

1248

45° banked curve course section · Double lane · Mean radius 300 mm (11¹³/₁₆"')

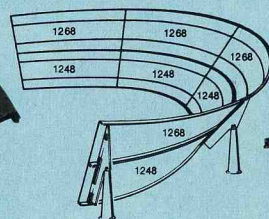

1268

45° banked curve course section · Double lane · Mean radius 450 mm (1 ft. 5³/₄"')

Inclines

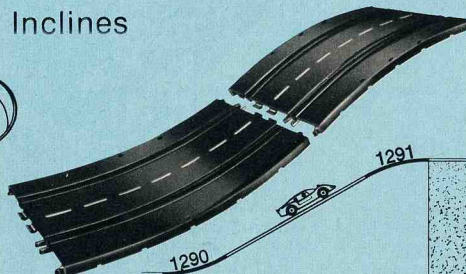

1291

Straight course section for end of incline · Similar to 1290 but convex · Includes a clip for increasing rigidity of the section

1290

Straight course section for start of incline · Double lane · Concave form · Angle of incline about 30° · Length 220 mm (8⁵/₈"')

1546

Set of banked curve supports · Consisting of 7 cross supports, 3 posts with a height of 128 mm (5"), 4 posts with a height of 78 mm (3¹/₁₆"') and 12 jointing sections · Made of plastic · Used with 4-lane banked curves



1595 new

Race control center · Electronic lap counter and timer · Can be positioned wherever required · "Start" and "Finish" markers are included · Lap counting operated through track contacts · 2 two-figure digital displays · Should be

connected to power pack 6771 or rectifier 1592 · 2 track contacts and one magnet each for 4 racing automobiles are included · This equipment is operated by means of two switches and five push buttons



The race control center and the race controller's tower are valuable additions to any racetrack layout.

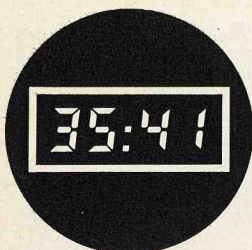

Counts laps from 1 to 99 on two lanes in either direction.

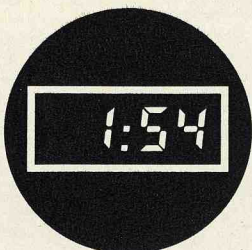

Can be switched to give a continuous display of elapsed time, on lane 1 or lane 2 as selected, in seconds and hundredths of a second.

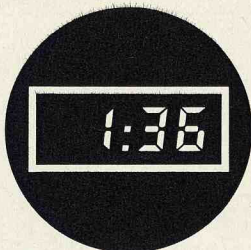

The fastest lap time on each lane is stored continuously, and this too can be monitored whenever required.

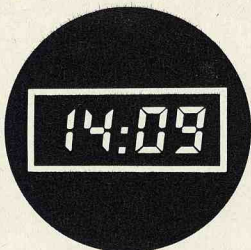

The race control center can also be switched to display ordinary clock time. To do this, it is necessary to set on the hours and minutes using the controls.

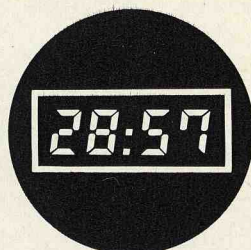

When using this equipment as a stop watch, two alternative ranges are possible:

1. From one hundredth of a second to 99 seconds and 99 hundredths of a second
2. From 1 second to 99 minutes and 59 seconds.

While these two functions are being monitored, the race control center continues to count laps automatically.

1550 new

Building kit for race controller's tower and walkway · The race control center and the race controller's tower together make up a real improvement to any racetrack layout · Race controller's tower has large all-round windows and observation platform · Walkway can be used over 2 or 4 lanes · Maximum length 40 cm (1 ft. 3 3/4")

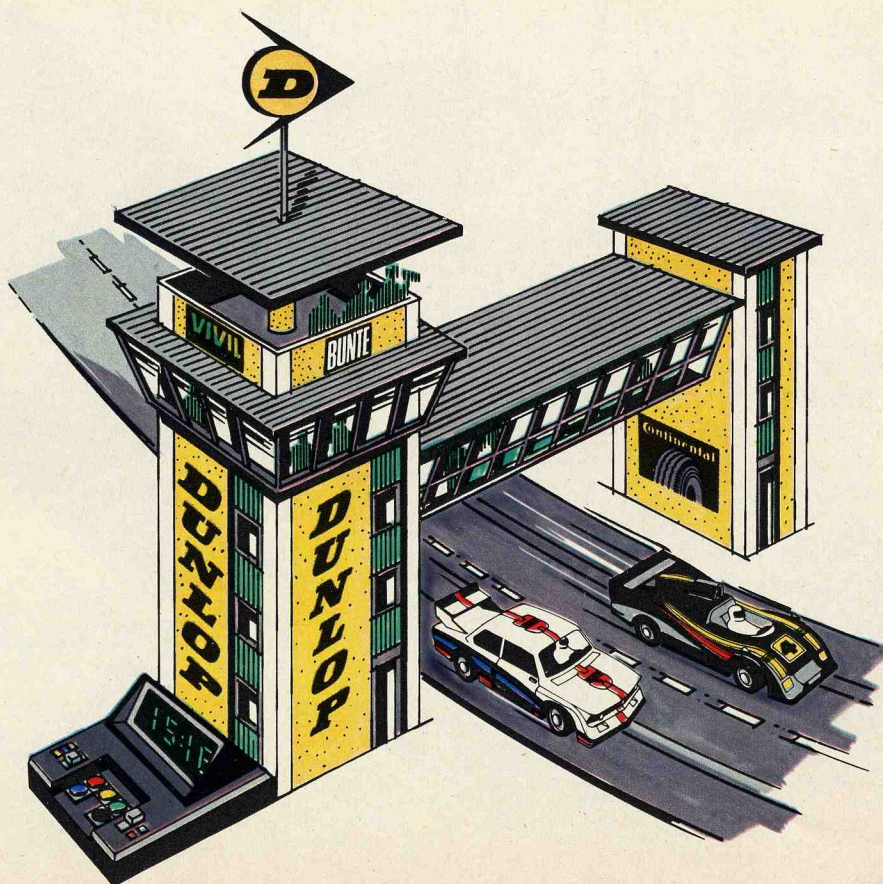

Race track accessories 1:32



1592

Rectifier · For connecting to Märklin railroad transformers · Dimensions 57 × 52 × 15 mm (2 1/4" × 2" × 5/8") · DC supply for operating up to 4 automobiles simultaneously can be taken from the two pairs of sockets marked "Auto 1" and "Auto 2" · The transformer used must be rated at 16 VA or more



1593

Starting clock · For connecting between the power pack and the race track layout · When the time set on the knob (adjustable between 0 and 5 minutes) has elapsed, the current supply to the track is cut off · Pressing the red "start" button gives clearance to start



1545

Mechanical lap counter · Mounted on a 106 mm (4 1/8") double lane course section · Displays up to 99 laps for each lane in either direction · Indicators zeroed by hand · Height 130 mm (5 1/8") · Width 150 mm (6") · A course section 1202 is required as a make-up length · On multi-lane courses several lap counters can be placed in a continuous line across the course



6771

Märklin sprint power pack for connecting to 220 V AC mains supply · Output approx. 14 V DC · Power output 10 watts · Overload protection by automatic current limiter · Plastic case · Weight 1.2 kg · Dimensions 125 × 135 × 55 mm (5" × 5 1/4" × 2 1/8")

The use of power pack 6771 is recommended. If Märklin railroad transformers are used it is essential to connect the rectifier 1592 between the transformer and the speed controller.



1591

Speed controller with connection kit · Red · Shaped for easy handling · The control key is notched to enable various speeds to be set · Built-in capacitor for radio interference suppression · The connection kit consists of a connector plate, which is connected to the speed controller by a 1.5 m (4 ft. 9") long two-core lead, and a 1 m (3 ft. 3") long two-core lead with a plug for connecting to the power pack · A speed controller may only be used to control one automobile at a time



1594

Speed controller with connection kit · Large version · 40 Ohms · Electrodynamic braking operates when press key is not being pressed · Built-in capacitor for radio interference suppression · Connection kit consists of a connector plate, which is connected to the speed controller by a 3-core lead, and a two-core lead with plugs for connecting to the power pack · A speed controller may only be used to control one automobile at a time

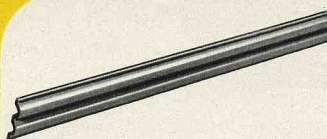

1540

Crash barrier · Corrugated type, made of flexible plastic · White · 2 m (6 ft. 6 3/4")



1541

Crash barrier support · Made of white plastic · For fixing crash barriers to the course

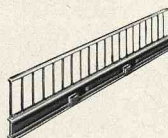

1544

Bridge parapet · For adding rigidity to overpasses · Made of gray plastic · Length 135 mm (5 3/16") · Height 38 mm (1 1/2")

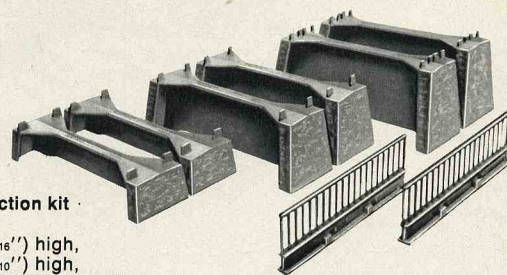

1542

Overpass construction kit · Consists of 2 piers 27 mm (1 1/16") high, 2 piers 49 mm (1 9/16") high, 2 piers 61.5 mm (2 5/16") high and 2 bridge parapets · All parts are made of gray plastic · Enables a very robust overpass to be built which is capable of spanning multi-lane courses



1547

Jointing section · Length 74 mm (2 9/16") · Made of black plastic · For connecting adjoining straight course sections and stiffening the joints

Tire sets

1500

Contains 2 rubber tires 20.5 mm (diameter) × 6 mm (13/16" × 1/4") · For models 1300, 1301, 1308, 1310, 1311, 1312, 1316, 1317, 1318

1501

Contains 2 rubber tires 23 mm (diameter) × 7 mm (7/8" × 5/16") · For models 1300, 1301

1503

Contains 2 rubber tires 20.5 mm (diameter) × 7.6 mm (13/16" × 9/16") · For models 1308, 1310, 1311, 1312, 1316, 1317, 1318

1505

Contains 2 rubber tires 20.5 mm (diameter) × 8.5 mm (13/16" × 5/8") · For models 1319, 1320, 1321, 1322, 1323, 1324, 1325, 1326, 1327, 1328, 1329

Current pick-up adapters

1510

(1 pair) · For clipping onto the pick-up skids of Märklin sprint automobiles · To enable them to be used on race tracks of other makes

Pair of carbon brushes

60146

for motors of Märklin sprint automobiles



One of the most important inventions ever
The screw thread is ingeniously simple, and for many practical applications there is nothing to beat it. If you master the use of nuts and bolts in your hobbying, you will understand the essence of engineering.



Practical construction hobby

The Märklin metall range offers endless scope to inventors and practical hobbyists. Even the tools show the functional character of Märklin metall.

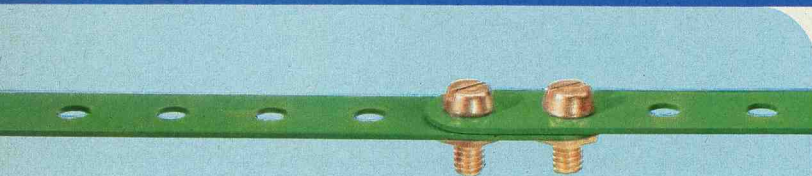

Rugged structures

Structures made with Märklin metall can withstand heavy loads indefinitely, being made of robust materials joined firmly together by nuts and bolts. Märklin models can be used vigorously and for as long as you like.

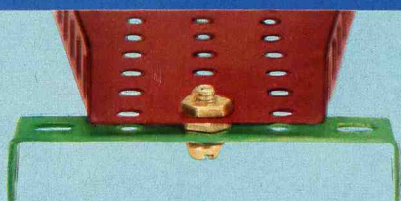

Moving parts add to the fun

Nut and bolt techniques are versatile and instructive. Non-rigid joints enable mechanisms to be devised. All sorts of things can be constructed from the simple basic components.

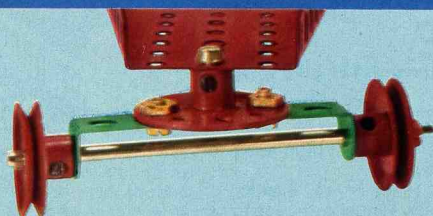

Functional realism

While enjoying this practical hobby you become familiar with engineering problems and practices. Gear wheels, pulleys, shafts, rollers, wheels, transmissions: the variety is stimulating and fascinating.

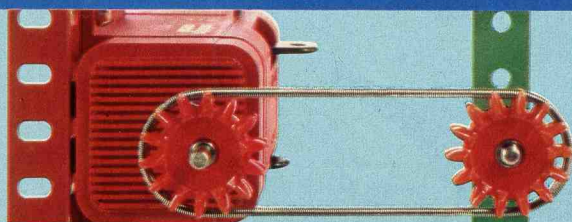

Design for mechanization

A vehicle made of Märklin metall parts is not just strong: it can be motorized, too, if you want it to be able to operate by itself. Märklin electric motors add both fun and value to this hobby.



Large instruction book

A 100 page instruction book is included with every basic set. The stages of construction of various models are clearly shown. From these examples you proceed to independent design and construction.

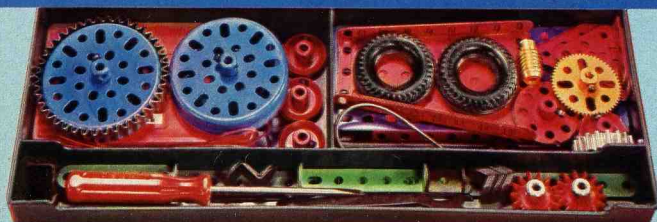

Robust compartmented boxes

All Märklin metall construction sets include these conveniently stacking compartmented boxes. This is the way to keep all components together tidily and in a readily accessible stowage.

Examples of models made with basic set A

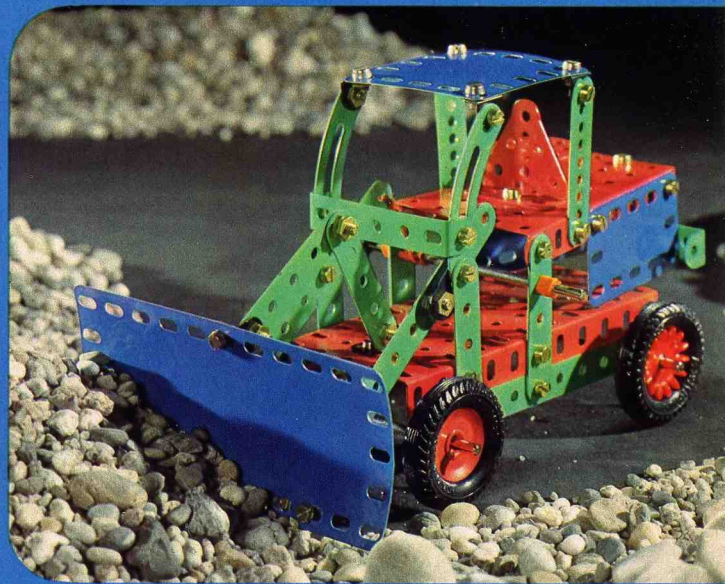
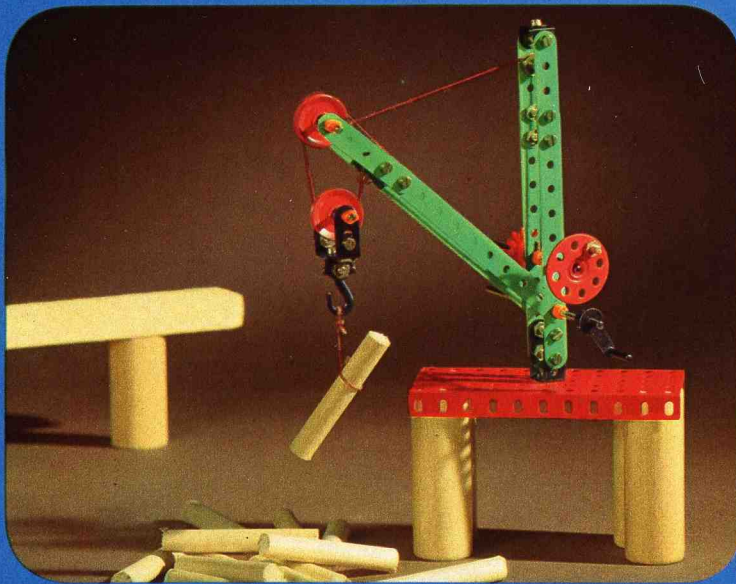

Märklin metall
basic set A 1051/1081

Märklin metall
extension set E1 1061/1091

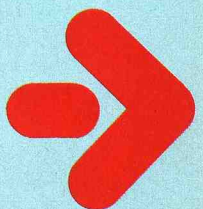

A + E1 = B

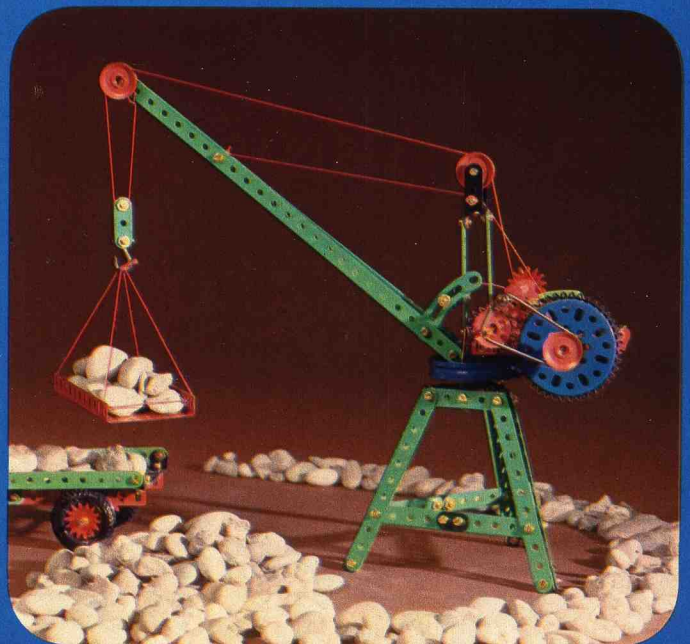
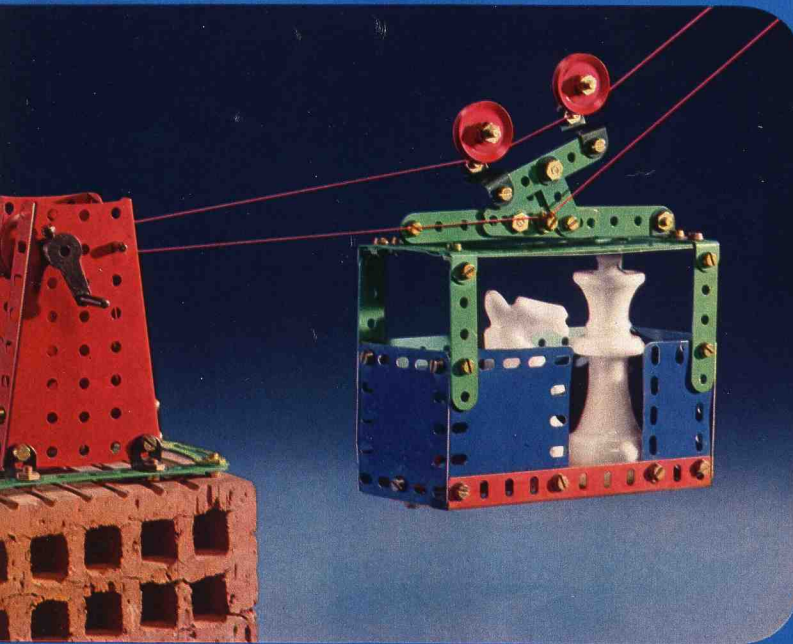
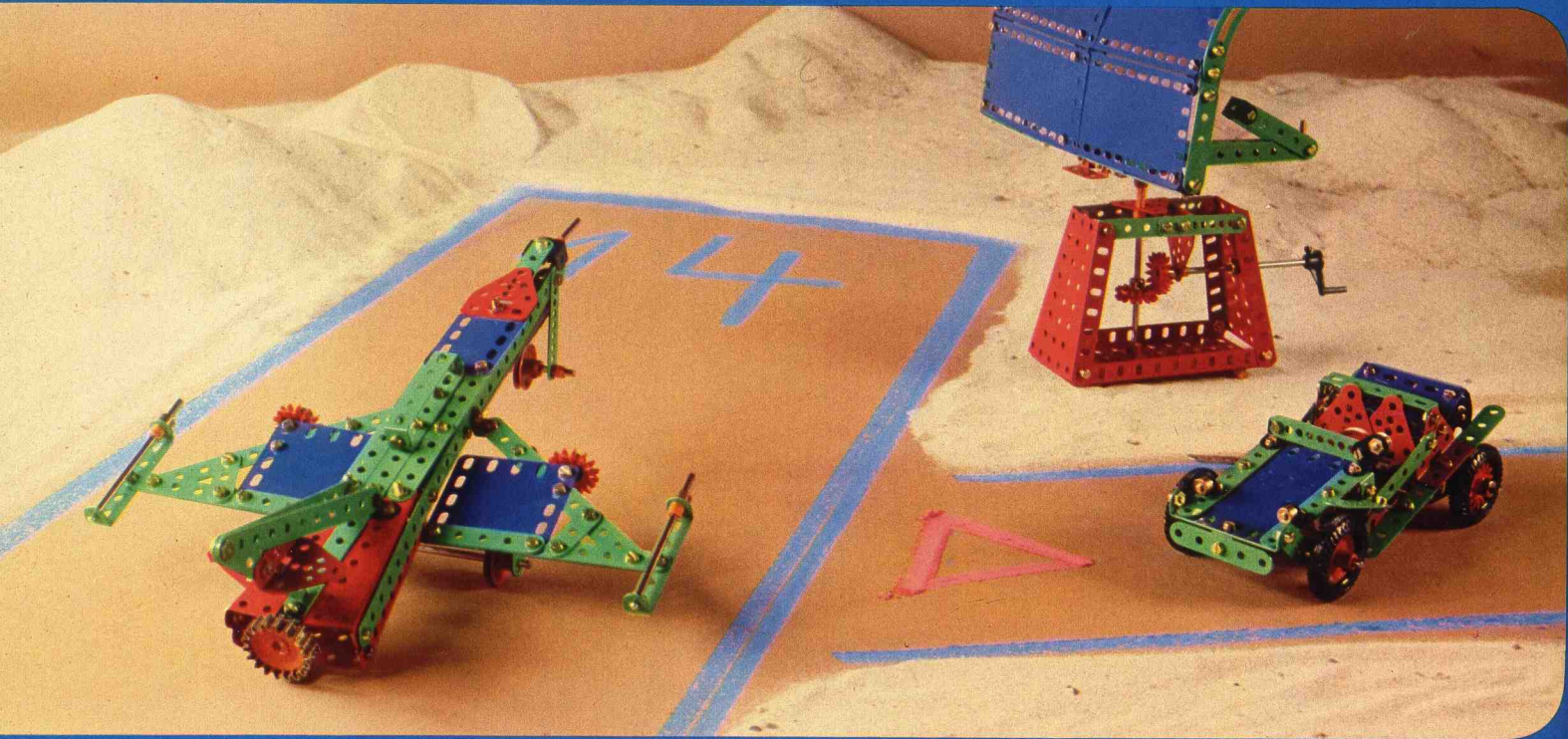

Märklin metall
basic set B 1052/1082

Märklin metall
extension set E2 1062/1092

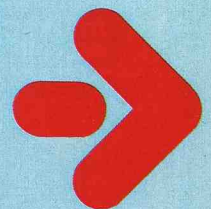

B + E2 = C

Examples of models made with basic set C

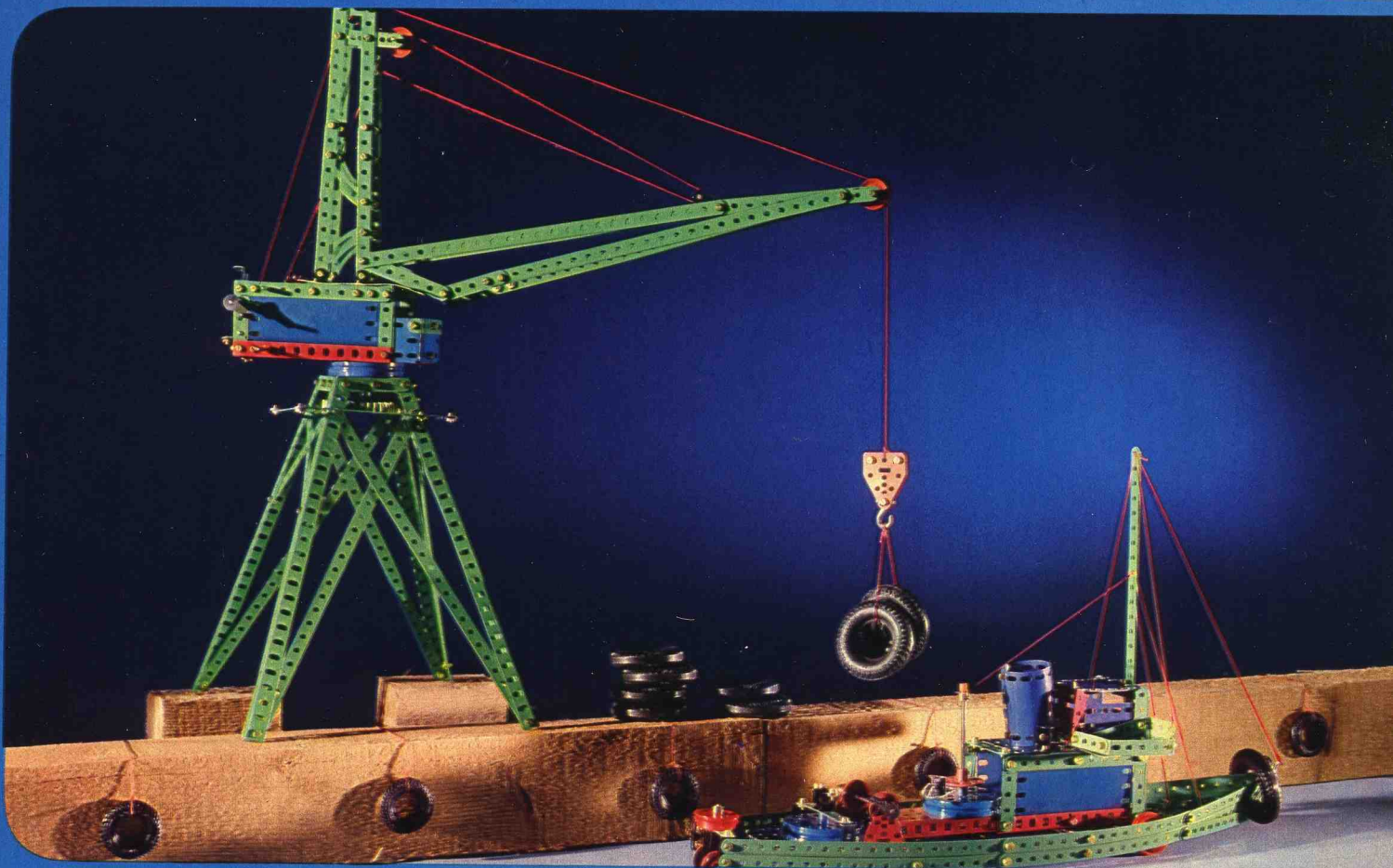
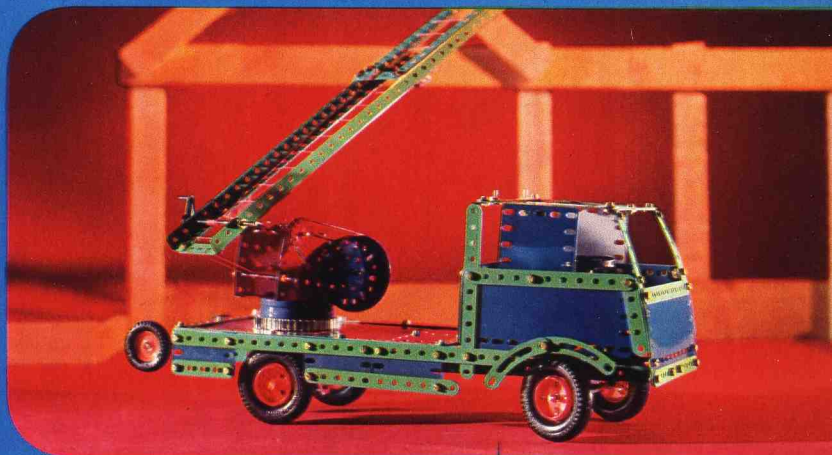

**märklin
metall**

das Baukastensystem
mit der echten
Schraubtechnik

richtig planen
praktisch bauen
sicher spielen

mit stabilen
Stiftschrauben

C

Märklin metall
basic set C 1053/1083

Märklin metall **new**
extension set E3 1063

Extends basic set C
one stage further.

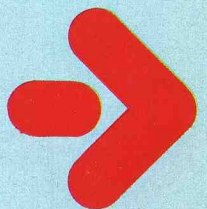



Märklin metall **new**
extension set E3 1063

Includes robust compartmented boxes and detailed instructions for building really good working models.

You can extend your kit as much as you like, with AC/DC electric motors, individual components, special items and assembly drawings. Even the more experienced designers have virtually unlimited scope.

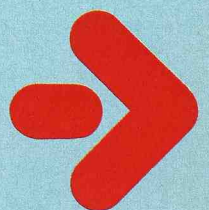

Unlimited scope for mechanization



1073

AC/DC electric motor incorporating gearbox with two selectable gear ratios and direction of rotation reversing switch · Speeds at no load approx. 250 and 1000 rpm

These AC/DC motors can be run from any model transformer with an output between 12 and 16 V AC or DC.

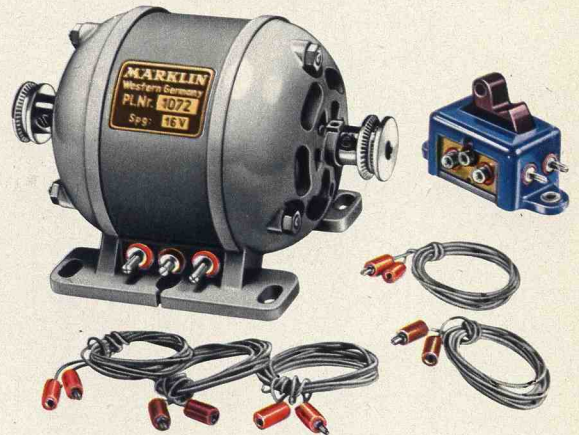

1072

ELEX AC/DC electric motor with 2 pulley wheels running in opposite directions and at different speeds · Speeds at no load approx. 1100 and 3000 rpm

Märklin metall electric motors are also very suitable for general purpose use in school or at work, at home and in hobby activities.

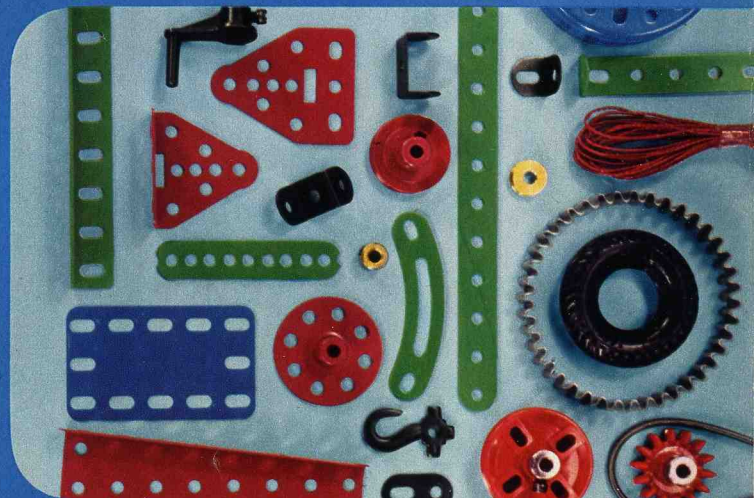
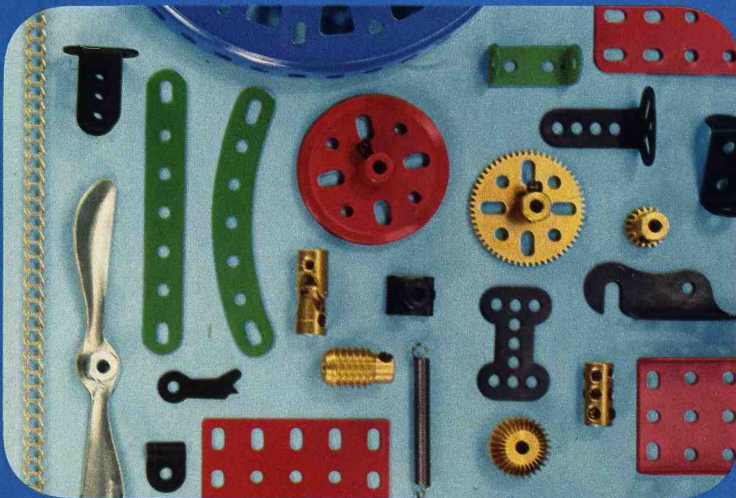

Märklin metall Special parts Individual components

Many special parts are available in Märklin metall to add the finishing touches to your models or to perform special functions.

All individual components used in the construction sets can also be purchased separately from your Märklin dealer.

The 1978 Märklin metall prospectus will give you full details of this special program.

There are no limits to the variety of ways in which Märklin metall special parts and individual components can be used.

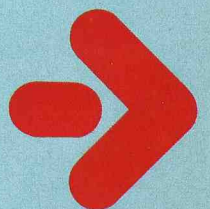



Assembly instructions for experienced Märklin metall modelers

These assembly plans for large Märklin metall models are laid out in clear step-by-step detail. The full scale originals of the Märklin metall models are illustrated on the reverse side of the multi-colored assembly plans. Parts lists for each stage make it easy to identify and procure any items which may be missing. This way you can make best use of the individual components in your kit.

14941 new

Assembly instructions for "Class 160 electric locomotive" · Length of model 75 cm (2 ft. 5½")

14942 new

Assembly instructions for "Der Adler" · Length of model 72 cm (2 ft. 4⅞")

14943 new

Assembly instructions for "Class 050 freight train locomotive" · Length of model 164 cm (5 ft. 4½")

Assembly kits for large models

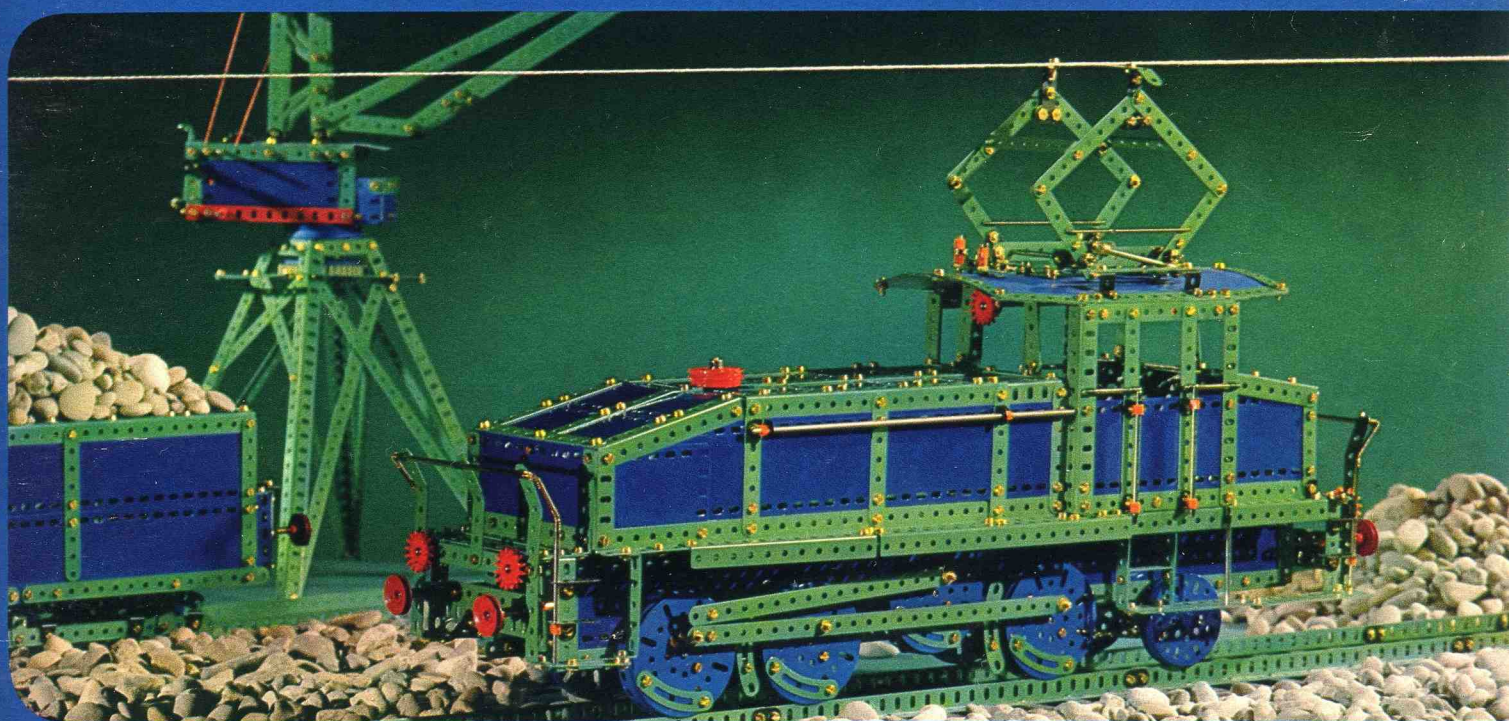
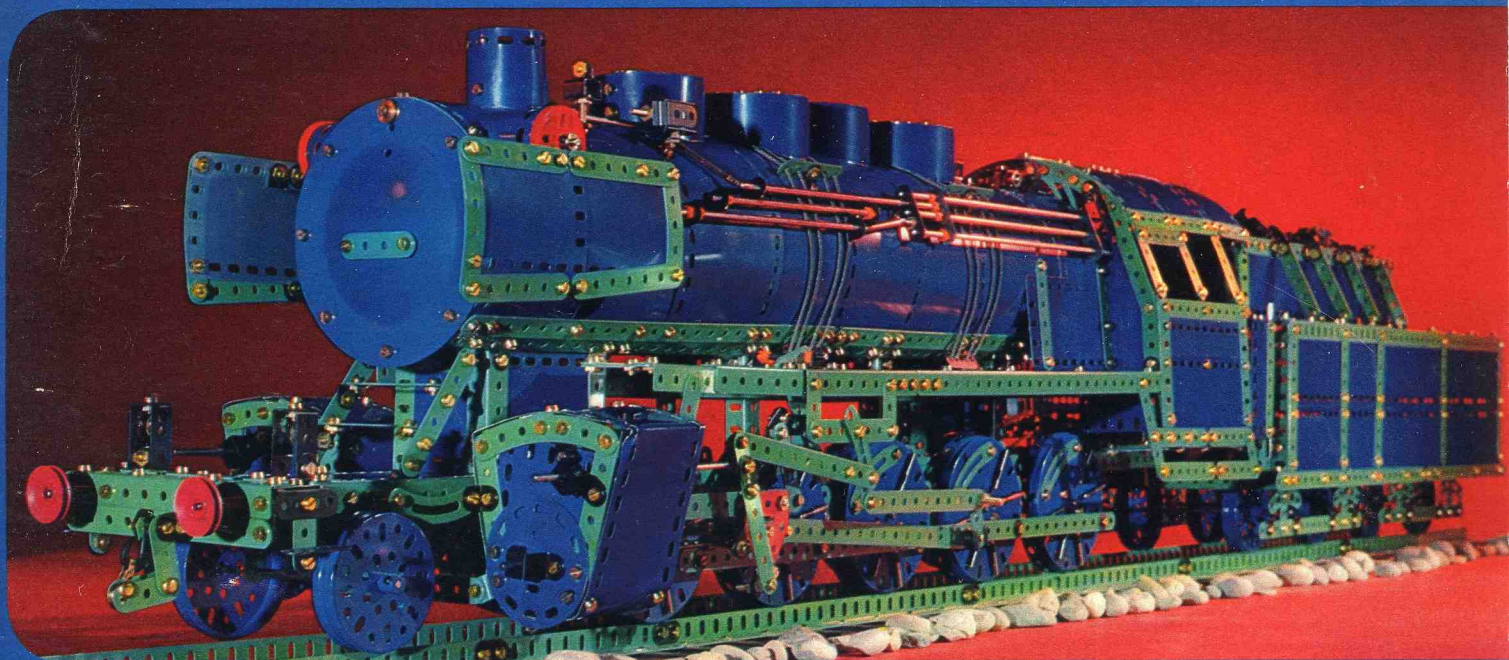

Everything you need for large models in
assembly kit form

An assembly kit contains all the Märklin metal
special parts and individual components required
for the construction of a large model, including
rails, tools, robust compartmented boxes and
assembly instructions.

1001 new

Assembly kit for
"Class 160 electric locomotive"

1002 new

Assembly kit for
"Der Adler"

1003 new

Assembly kit for
"Class 050 freight train locomotive"

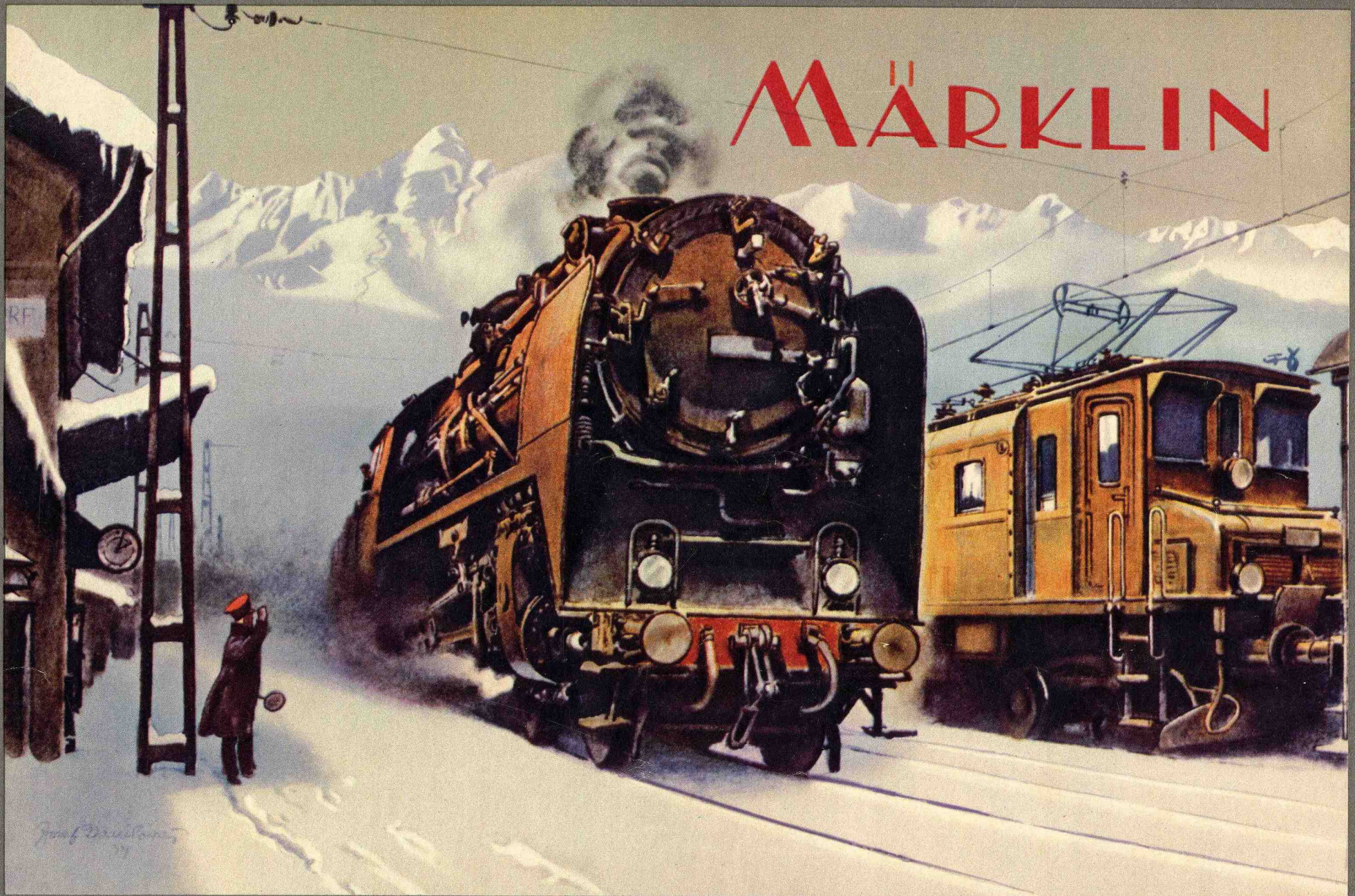

For Märklin enthusiasts: A copy of the cover page of the 1934 Märklin catalog